

## DDLDF-1050ZZ

2023/03/22

## Outline

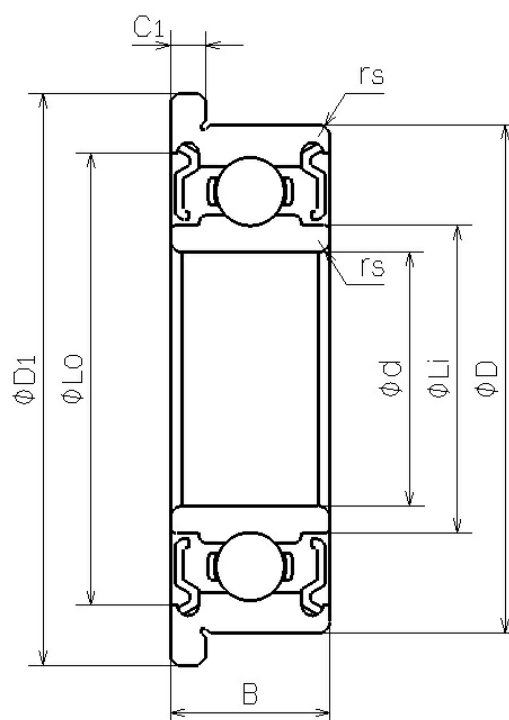

NMB Parts No.	DDLDF-1050ZZ
Metric or Inch	Metric
ISO/JIS	-
Material of Rings	Stainless Steel
Ring Type	[Radial] Flanged
Inner Diameter (d) [mm]	5.000
Outer Diameter (D) [mm]	10.000
Width	

## DDLDF-1050ZZ

2023/03/22

(B) [mm]	4.000
Chamfer (rs min) [mm]	0.100
Flange Diameter (D1) [mm]	11.600
Flange Width (C1) [mm]	0.800
Reference Diameter Outer (Lo) [mm]	8.940
Reference Diameter Inner (Li) [mm]	6.400
Ball Size (DW) [mm]	1.5875
Ball Complement (Z)	8
Dynamic Load Rating (Cr) [N]	714
Static Load Rating (Cor) [N]	276
Inner Diameter (d) [in]	0.1969
Outer Diameter (D) [in]	0.3937
Flange Diameter (D1) [in]	0.4567
Flange Width (C1) [in]	0.0315