

DDLDF-1370ZZ

2023/03/22

Outline

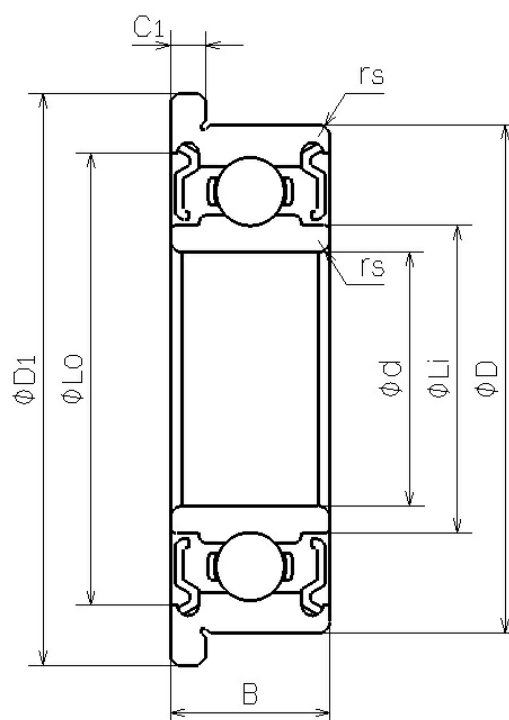

NMB Parts No.	DDLDF-1370ZZ
Metric or Inch	Metric
ISO/JIS	-
Material of Rings	Stainless Steel
Ring Type	[Radial] Flanged
Inner Diameter (d) [mm]	7.000
Outer Diameter (D) [mm]	13.000
Width	

DDLDF-1370ZZ

2023/03/22

(B) [mm]	4.000
Chamfer (rs min) [mm]	0.150
Flange Diameter (D1) [mm]	14.600
Flange Width (C1) [mm]	0.800
Reference Diameter Outer (Lo) [mm]	11.540
Reference Diameter Inner (Li) [mm]	8.430
Ball Size (DW) [mm]	1.5875
Ball Complement (Z)	11
Dynamic Load Rating (Cr) [N]	880
Static Load Rating (Cor) [N]	414
Inner Diameter (d) [in]	0.2756
Outer Diameter (D) [in]	0.5118
Flange Diameter (D1) [in]	0.5748
Flange Width (C1) [in]	0.0315