

DDLDF-840ZZ

2023/03/22

Outline

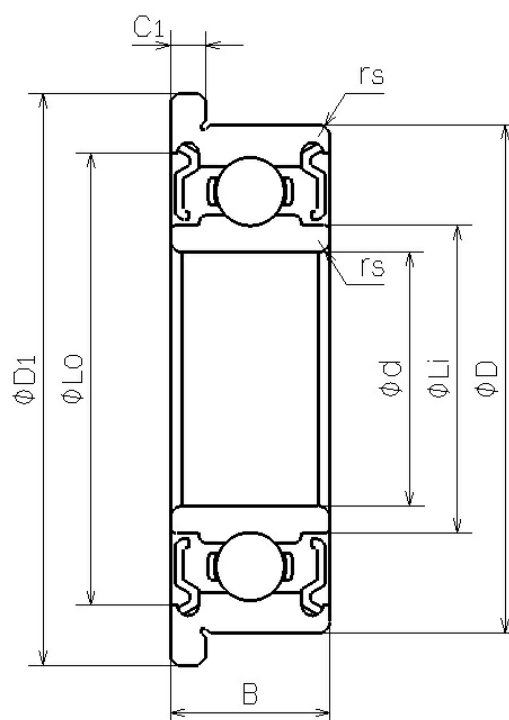

NMB Parts No.	DDLDF-840ZZ
Metric or Inch	Metric
ISO/JIS	-
Material of Rings	Stainless Steel
Ring Type	[Radial] Flanged
Inner Diameter (d) [mm]	4.000
Outer Diameter (D) [mm]	8.000
Width	

DDLDF-840ZZ

2023/03/22

(B) [mm]	3.000
Chamfer (rs min) [mm]	0.100
Flange Diameter (D1) [mm]	9.200
Flange Width (C1) [mm]	0.600
Reference Diameter Outer (Lo) [mm]	7.240
Reference Diameter Inner (Li) [mm]	5.200
Ball Size (DW) [mm]	1.1906
Ball Complement (Z)	7
Dynamic Load Rating (Cr) [N]	391
Static Load Rating (Cor) [N]	140
Inner Diameter (d) [in]	0.1575
Outer Diameter (D) [in]	0.3150
Flange Diameter (D1) [in]	0.3622
Flange Width (C1) [in]	0.0236