

DDLDF-850ZZ

2023/03/22

Outline

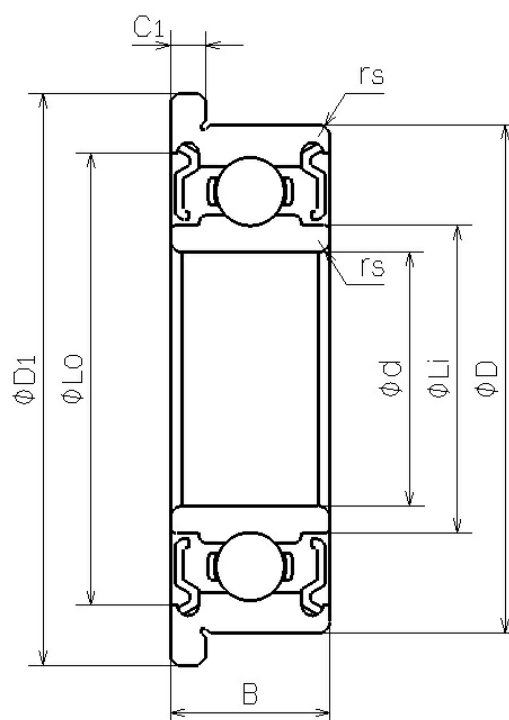

NMB Parts No.	DDLDF-850ZZ
Metric or Inch	Metric
ISO/JIS	-
Material of Rings	Stainless Steel
Ring Type	[Radial] Flanged
Inner Diameter (d) [mm]	5.000
Outer Diameter (D) [mm]	8.000
Width	

DDLDF-850ZZ

2023/03/22

(B) [mm]	2.500
Chamfer (rs min) [mm]	0.080
Flange Diameter (D1) [mm]	9.200
Flange Width (C1) [mm]	0.600
Reference Diameter Outer (Lo) [mm]	7.260
Reference Diameter Inner (Li) [mm]	5.800
Ball Size (DW) [mm]	0.7938
Ball Complement (Z)	13
Dynamic Load Rating (Cr) [N]	274
Static Load Rating (Cor) [N]	130
Inner Diameter (d) [in]	0.1969
Outer Diameter (D) [in]	0.3150
Flange Diameter (D1) [in]	0.3622
Flange Width (C1) [in]	0.0236