

DDRF-1140ZZ

2023/03/22

Outline

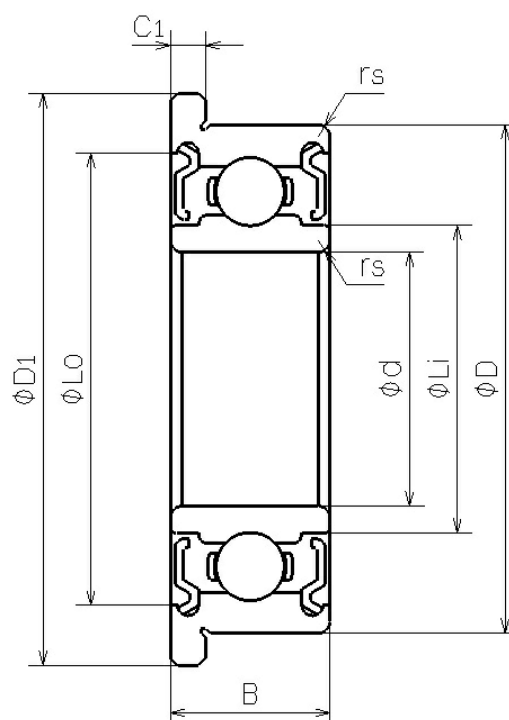

NMB Parts No.	DDRF-1140ZZ
Metric or Inch	Metric
ISO/JIS	F694ZZ
Material of Rings	Stainless Steel
Ring Type	[Radial] Flanged
Inner Diameter (d) [mm]	4.000
Outer Diameter (D) [mm]	11.000
Width	

DDRF-1140ZZ

2023/03/22

(B) [mm]	4.000
Chamfer (rs min) [mm]	0.150
Flange Diameter (D1) [mm]	12.500
Flange Width (C1) [mm]	1.000
Reference Diameter Outer (Lo) [mm]	9.540
Reference Diameter Inner (Li) [mm]	6.400
Ball Size (DW) [mm]	1.5875
Ball Complement (Z)	8
Dynamic Load Rating (Cr) [N]	714
Static Load Rating (Cor) [N]	276
Inner Diameter (d) [in]	0.1575
Outer Diameter (D) [in]	0.4331
Flange Diameter (D1) [in]	0.4921
Flange Width (C1) [in]	0.0394