

DDRF-1560ZZ

2023/03/22

Outline

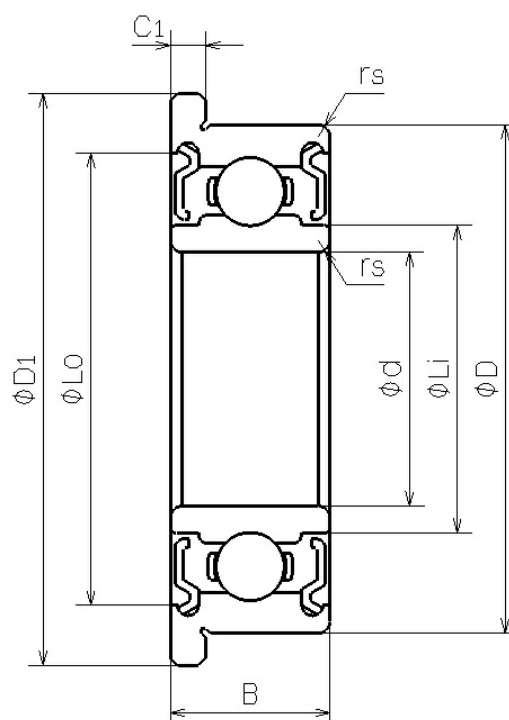

NMB Parts No.	DDRF-1560ZZ
Metric or Inch	Metric
ISO/JIS	F696ZZ
Material of Rings	Stainless Steel
Ring Type	[Radial] Flanged
Inner Diameter (d) [mm]	6.000
Outer Diameter (D) [mm]	15.000
Width	

DDRF-1560ZZ

2023/03/22

(B) [mm]	5.000
Chamfer (rs min) [mm]	0.200
Flange Diameter (D1) [mm]	17.000
Flange Width (C1) [mm]	1.200
Reference Diameter Outer (Lo) [mm]	13.200
Reference Diameter Inner (Li) [mm]	7.800
Ball Size (DW) [mm]	2.7781
Ball Complement (Z)	7
Dynamic Load Rating (Cr) [N]	1735
Static Load Rating (Cor) [N]	671
Inner Diameter (d) [in]	0.2362
Outer Diameter (D) [in]	0.5906
Flange Diameter (D1) [in]	0.6693
Flange Width (C1) [in]	0.0472