

DDRF-1640ZZ

2021/09/13

Outline

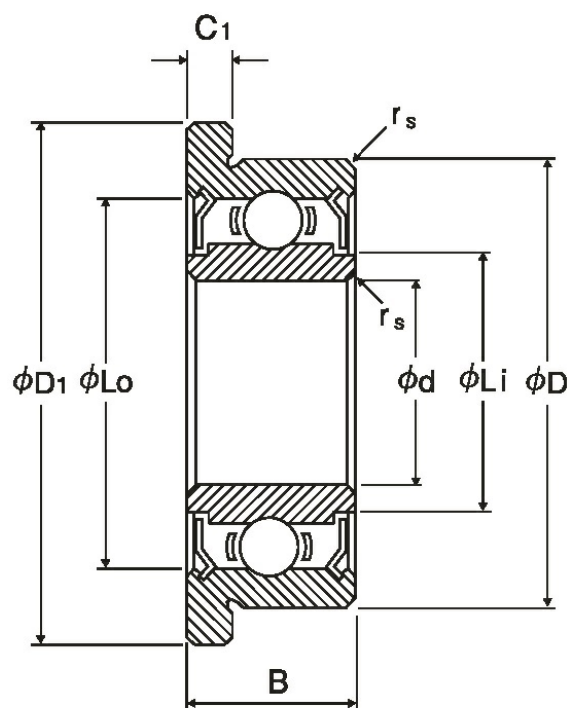

NMB Parts No.	DDRF-1640ZZ
Metric or Inch	Metric
ISO/JIS	F634ZZ
Material of Rings	Stainless Steel
Ring Type	[Radial]Flanged
Inner Diameter (d) [mm]	4.000
Outer Diameter (D) [mm]	16.000
Width (B) [mm]	5.000
Chamfer (rs min) [mm]	0.300
Flange Diameter (D1)	16.000

DDRF-1640ZZ

2021/09/13

(D1) [mm] Flange Width	18.000
(C1) [mm] Reference Diameter Outer	1.000
(Lo) [mm] Reference Diameter Inner	13.200
(Li) [mm] Ball Size	7.800
(DW) [mm] Ball Complement	2.7781
(Z) Dynamic Load Rating	7
(Cr) [N] Static Load Rating	1735
(Cor) [N] Inner Diameter	671
(d) [in] Outer Diameter	0.1575
(D) [in] Flange Diameter	0.6299
(D1) [in] Flange Width	0.7087
(C1) [in]	0.0394