

DDRF-1970ZZ

2023/03/22

Outline

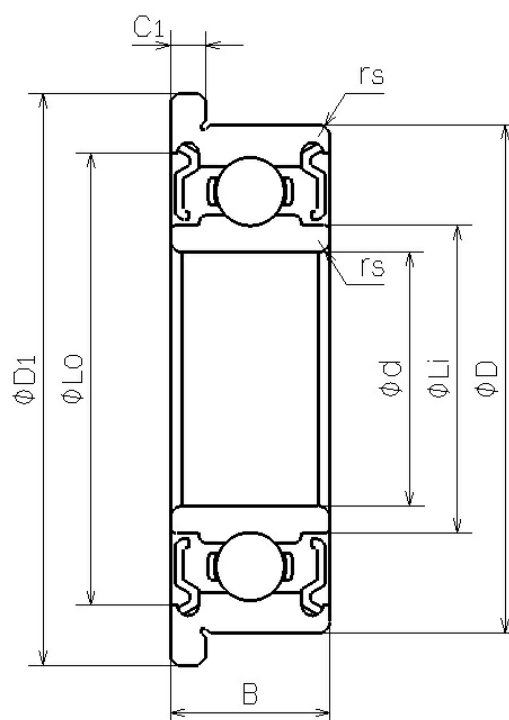

NMB Parts No.	DDRF-1970ZZ
Metric or Inch	Metric
ISO/JIS	F607ZZ
Material of Rings	Stainless Steel
Ring Type	[Radial] Flanged
Inner Diameter (d) [mm]	7.000
Outer Diameter (D) [mm]	19.000
Width	

DDRF-1970ZZ

2023/03/22

(B) [mm]	6.000
Chamfer (rs min) [mm]	0.300
Flange Diameter (D1) [mm]	22.000
Flange Width (C1) [mm]	1.500
Reference Diameter Outer (Lo) [mm]	16.240
Reference Diameter Inner (Li) [mm]	9.550
Ball Size (DW) [mm]	3.1750
Ball Complement (Z)	7
Dynamic Load Rating (Cr) [N]	2240
Static Load Rating (Cor) [N]	912
Inner Diameter (d) [in]	0.2756
Outer Diameter (D) [in]	0.7480
Flange Diameter (D1) [in]	0.8661
Flange Width (C1) [in]	0.0591