

DDRIF-4ZZ

2023/03/22

Outline

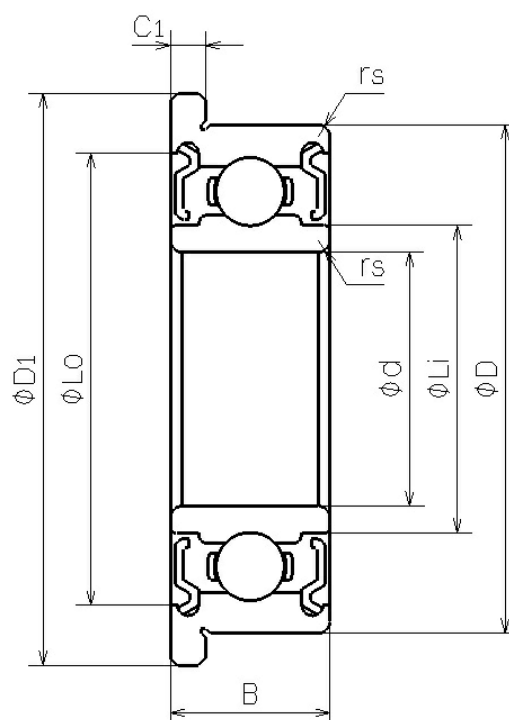

NMB Parts No.	DDRIF-4ZZ
Metric or Inch	Inch
ISO/JIS	-
Material of Rings	Stainless Steel
Ring Type	[Radial] Flanged
Inner Diameter (d) [mm]	1.984
Outer Diameter (D) [mm]	6.350
Width	

DDRIF-4ZZ

2023/03/22

(B) [mm]	3.571
Chamfer (rs min) [mm]	0.080
Flange Diameter (D1) [mm]	7.518
Flange Width (C1) [mm]	0.787
Reference Diameter Outer (Lo) [mm]	5.230
Reference Diameter Inner (Li) [mm]	3.100
Ball Size (DW) [mm]	1.1906
Ball Complement (Z)	6
Dynamic Load Rating (Cr) [N]	330
Static Load Rating (Cor) [N]	99
Inner Diameter (d) [in]	0.0781
Outer Diameter (D) [in]	0.2500
Flange Diameter (D1) [in]	0.2960
Flange Width (C1) [in]	0.0310