

## DDT-1260

2023/03/22

## Outline

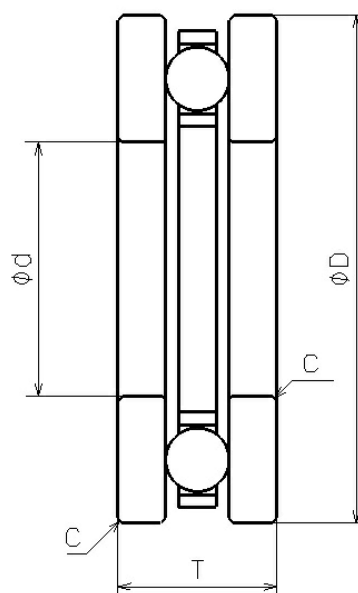

NMB Parts No.	DDT-1260
Metric or Inch	Metric
ISO/JIS	-
Material of Rings	Stainless Steel
Ring Type	[Thrust] without groove
Inner Diameter (d) +0.040 +0.020 [mm]	6.000
Outer Diameter (D)	12.000

## DDT-1260

2023/03/22

+0 -0.011 [mm]	12.000
Height (T) +0 -0.075 [mm]	4.500
Chamfer (C) [mm]	0.2
Ball Size (DW) [mm]	1.5875
Ball Complement (Z)	9
Inner Diameter (d) [in]	0.2362
Outer Diameter (D) [in]	0.4724