

## DDT-1570

2023/03/22

## Outline

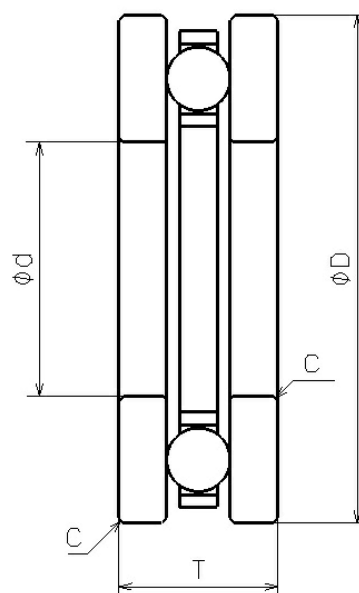

NMB Parts No.	DDT-1570
Metric or Inch	Metric
ISO/JIS	-
Material of Rings	Stainless Steel
Ring Type	[Thrust] without groove
Inner Diameter (d) +0.040 +0.020 [mm]	7.000
Outer Diameter (D)	15.000

## DDT-1570

2023/03/22

+0 -0.011 [mm]	15.000
Height (T) +0 -0.075 [mm]	5.000
Chamfer (C) [mm]	0.3
Ball Size (DW) [mm]	2.0000
Ball Complement (Z)	7
Inner Diameter (d) [in]	0.2756
Outer Diameter (D) [in]	0.5906