

DDT-830

2023/03/22

Outline

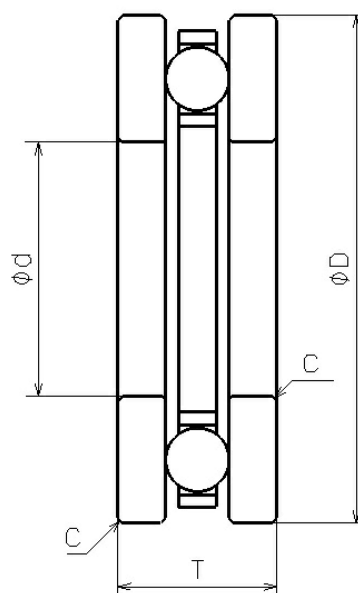

NMB Parts No.	DDT-830
Metric or Inch	Metric
ISO/JIS	-
Material of Rings	Stainless Steel
Ring Type	[Thrust] without groove
Inner Diameter (d) +0.040 +0.020 [mm]	3.000
Outer Diameter (D)	3.000

DDT-830

2023/03/22

+0 -0.011 [mm]	8.000
Height (T) +0 -0.075 [mm]	3.500
Chamfer (C) [mm]	0.2
Ball Size (DW) [mm]	1.1906
Ball Complement (Z)	7
Inner Diameter (d) [in]	0.1181
Outer Diameter (D) [in]	0.3150