

C4-K3L

RoHS AEC-Q200 Shielded structure

2023/03/22

Outline



High efficiency and Low DCR power inductor for battery-driven portable electric equipment power supplies (DC-DC converter, switching power supply) and other electronic equipment.

Features

1. Low DCR
2. Low profile and high current
3. Magnetically shielded structure for electromagnetic interference

Applications

For DSCs, DVD/MP3 Players, Mobile Phones, Notebook Computers, LCD TVs, PDP TVs, Car Navigations, and other electronic equipment.

C4-K3L

RoHS AEC-Q200 Shielded structure

2023/03/22

Dimensions

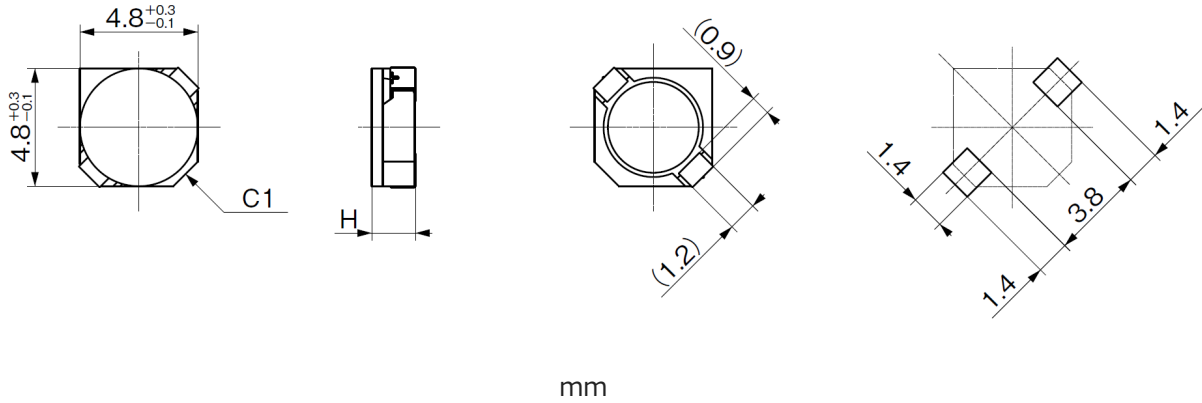

Package Dimension

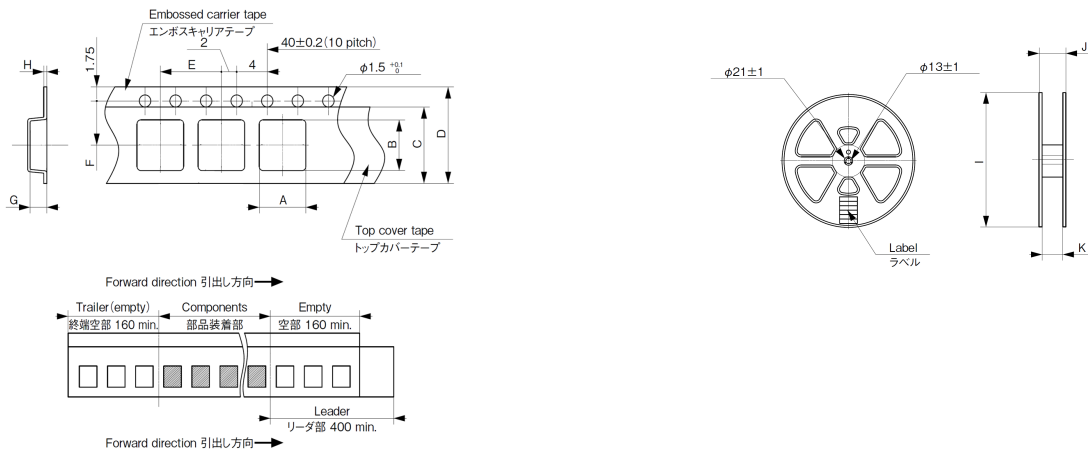

Q'ty [pcs./reel]	Tape Dimensions A [mm]	Tape Dimensions B [mm]	Tape Dimensions C a [mm]	Tape Dimensions C b [mm]	Tape Dimensions D a [mm]	Tape Dimensions D b [mm]
2000	5.3	5.3	9.5	0.2	12	0.3

Tape Dimensions E a [mm]	Tape Dimensions E b [mm]	Tape Dimensions F a [mm]	Tape Dimensions F b [mm]	Tape Dimensions G a [mm]	Tape Dimensions G b [mm]	Tape Dimensions H a [mm]

C4-K3L

RoHS AEC-Q200 Shielded structure

2023/03/22

8	0.1	5.5	0.1	3.2	0.2	0.3
Tape Dimensions H b [mm]	Reel Dimensions I a [mm]	Reel Dimensions I b [mm]	Reel Dimensions J b [mm]	Reel Dimensions K a [mm]	Reel Dimensions K b [mm]	
0.10	φ 330	φ 2	1	13.5	1	