

Protection for Lithium-Ion/Lithium Polymer Batteries (1 cell) Monolithic IC MM3090 Series

April 26, 2004

Outline

This is a protection IC developed for use with 1-serial cell lithium-ion/lithium polymer rechargeable batteries. It provides a function to protect the batteries by detecting overcharge, overdischarge, discharge overcurrent, and other abnormalities and turning off the external Nch MOS FET. The outputs of C_{OUT} pin(charge FET control pin) and D_{OUT} pin(discharge FET control pin) are CMOS outputs, so that the external Nch MOS FET can be driven directly. A charge overcurrent detection function is provided for abnormal charger detection. In addition, the IC has a built-in timer circuit (for each detection delay time), so that the protection circuitry can be comprised with fewer external components. Furthermore, by setting the DS pin at V_{DD} level, overcharge, overdischarge, discharge overcurrent can be detected, and the delay time during release can be shortened. The device returns from an overdischarge state if the battery voltage is higher than the overdischarge release voltage when a charger is connected or even not connected.

Features

- | | |
|--|---|
| 1. Uses high voltage CMOS process | Absolute maximum rating for charger connection 28V |
| 2. Detection voltage precision | Overcharge detection voltage
±20mV (Ta=25°C), ±25mV (Ta=-5~60°C)
Overdischarge detection voltage
±35mV (Ta=25°C), ±58mV (Ta=-5~60°C)
Discharge overcurrent detection voltage
±10mV (Ta=25°C), ±15mV (Ta=-5~60°C) |
| 3. Built-in detection delay times (timer circuit) | Overcharge detection delay time 0.25~7.0s (mask option)
Overdischarge detection delay time 4~128ms (mask option)
Discharge overcurrent detection delay time 4~128ms (mask option)
Short detection delay time |
| 4. Includes a charge overcurrent detection function | |
| 5. Overcharge, overdischarge, and discharge overcurrent can be detected, and the delay time during release can be shortened with the DS pin. | |
| 6. 0V charge disable function (mask option) | |

Package

SOT-26A
SON-6A

Pin Assignment

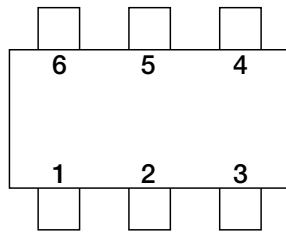

SOT-26A
(TOP VIEW)

1	D _{OUT}
2	V ₋
3	C _{OUT}
4	DS
5	V _{DD}
6	V _{SS}

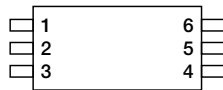

SON-6A
(TOP VIEW)

1	D _{OUT}
2	V _{DD}
3	V _{SS}
4	DS
5	C _{OUT}
6	V ₋

Block Diagram

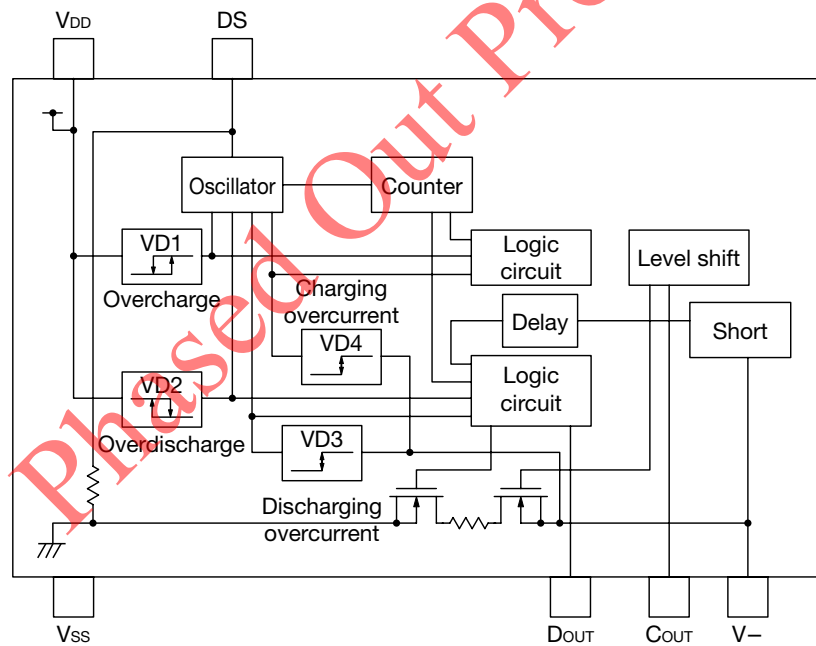

Pin Description

SOT-26A

Pin no.	Pin name	Functions
1	DOUT	Output of overdischarge detection. Output type is CMOS.
2	V-	Input terminal connected to charger negative voltage.
3	COUT	Output of overcharge detection. Output type is CMOS.
4	DS	Delay shorten terminal.
5	VDD	VDD terminal. Connected to IC substrate.
6	VSS	VSS terminal. Connected to ground.

SON-6A

Pin no.	Pin name	Functions
1	DOUT	Output of overdischarge detection. Output type is CMOS.
2	VDD	VDD terminal. Connected to IC substrate.
3	VSS	VSS terminal. Connected to ground.
4	DS	Delay shorten terminal.
5	COUT	Output of overcharge detection. Output type is CMOS.
6	V-	Input terminal connected to charger negative voltage.

Absolute Maximum Ratings (T_{OPR}=25°C, V_{SS}=0V)

Item	Symbol	Ratings	Units
Supply voltage	V _{DD}	-0.3~12	V
V terminal input voltage	V-	V _{DD} -28~V _{DD} +0.3	V
DS terminal input voltage	V _{DS}	V _{SS} -0.3~V _{DD} +0.3	V
C _{OUT} terminal output voltage	V _{COUT}	V _{DD} -28~V _{DD} +0.3	V
D _{OUT} terminal output voltage	V _{DOUT}	V _{SS} -0.3~V _{DD} +0.3	V
Operation temperature	T _{OPR}	-40~+85	°C
Storage temperature	T _{STG}	-55~+125	°C

Electrical Characteristics

T_{OPR}=25°C (Models listed : MM3090A)

Item	Symbol	Measurement conditions	Min.	Typ.	Max.	Units	*1
Operating input voltage	V _{DD1}	V _{DD} -V _{SS}	1.5		10.0	V	A
Minimum operating voltage for 0V charging	V _{ST}	V _{DD} -V-, V _{DD} -V _{SS} =0V			1.2	V	A
Overcurrent release resistance	R _{SHORT}	V _{DD} =3.6V, V-=-1V	30	50	100	kΩ	F
DS pin PULL DOWN resistance	R _{DS}	V _{DD} =3.6V	6.5	13.0	26.0	kΩ	H
C _{OUT} Nch ON voltage	V _{OL1}	I _{OL} =30μA, V _{DD} =4.5V		0.4	0.5	V	I
C _{OUT} Pch ON voltage	V _{OH1}	I _{OL} =-30μA, V _{DD} =3.9V	3.4	3.7		V	J
D _{OUT} Nch ON voltage	V _{OL2}	I _{OL} =30μA, V _{DD} =2.0V		0.2	0.5	V	K
D _{OUT} Pch ON voltage	V _{OH2}	I _{OL} =-30μA, V _{DD} =3.9V	3.4	3.7		V	L
Current consumption	I _{DD}	V _{DD} =3.9V, V-=-0V		3.0	6.0	μA	M
Current consumption at stand-by	I _S	V _{DD} =2.0V		0.2	0.5	μA	M

Note: *1 The test circuit symbols.

■ T_{OPR}=25°C

Item	Symbol	Measurement conditions	Min.	Typ.	Max.	Units	*1
Overcharge detection voltage	V _{DET1}	R1=330Ω	4.280	4.300	4.320	V	B
Overcharge release voltage	V _{REL1}	R1=330Ω	4.070	4.100	4.130	V	B
Overcharge hysteresis voltage	V _{HYS1}	R1=330Ω, V _{HYS1} =V _{DET1} -V _{REL1}	0.170	0.200	0.230	V	B
Overdischarge detection voltage	V _{DET2}	V ₋ =0V, R1=330Ω	2.365	2.400	2.435	V	D
Overdischarge release voltage	V _{REL2}	V ₋ =OPEN, R1=330Ω	2.865	2.900	2.935	V	D
Discharging overcurrent detection voltage	V _{DET3}	V _{DD} =3V, R2=2.2kΩ	0.140	0.150	0.160	V	F
Charging overcurrent detection voltage	V _{DET4}	V _{DD} =3V, R2=2.2kΩ	0.080	0.100	0.120	V	G
Short detection voltage	V _{SHORT}	V _{DD} =3V	V _{DD} -1.2	V _{DD} -0.9	V _{DD} -0.6	V	F
Overcharge detection delay time	tV _{DET1}	V _{DD} =3.6V→4.4V	0.80	1.00	1.20	s	B
Overcharge release delay time	tV _{REL1}	V _{DD} =4.4V→3.6V	6.4	8.0	9.6	ms	B
Overdischarge detection delay time	tV _{DET2}	V _{DD} =3.6V→2.2V	76.8	96.0	115.2	ms	D
Overdischarge release delay time	tV _{REL2}	V _{DD} =3V, V ₋ =3V→0V	3.2	4.0	4.8	ms	E
Discharging overcurrent detection delay time	tV _{DET3}	V _{DD} =3V, V ₋ =0V→1V	9.6	12.0	14.4	ms	F
Discharging overcurrent release delay time	tV _{REL3}	V _{DD} =3V, V ₋ =3V→0V	3.2	4.0	4.8	ms	G
Charging overcurrent detection delay time	tV _{DET4}	V _{DD} =3V, V ₋ =0V→-1V	4.8	6.0	7.2	ms	G
Charging overcurrent release delay time	tV _{REL4}	V _{DD} =3V, V ₋ =-1V→0V	3.2	4.0	4.8	ms	F
Short detection delay time	t _{SHORT}	V _{DD} =3V, V ₋ =0V→3V	280	400	560	μs	F

Note: *1 The test circuit symbols.

■ T_{OPR}=5~60°C *2

Item	Symbol	Measurement conditions	Min.	Typ.	Max.	Units	*1
Overcharge detection voltage	V _{DET1}	R1=330Ω	4.275	4.300	4.325	V	B
Overcharge release voltage	V _{REL1}	R1=330Ω	4.050	4.100	4.150	V	B
Overcharge hysteresis voltage	V _{HYS1}	R1=330Ω, V _{HYS1} =V _{DET1} -V _{REL1}	0.150	0.200	0.250	V	B
Overdischarge detection voltage	V _{DET2}	V ₋ =0V, R1=330Ω	2.342	2.400	2.458	V	D
Overdischarge release voltage	V _{REL2}	V ₋ =OPEN, R1=330Ω	2.865	2.900	2.935	V	D
Discharging overcurrent detection voltage	V _{DET3}	V _{DD} =3V, R2=2.2kΩ	0.135	0.150	0.165	V	F
Charging overcurrent detection voltage	V _{DET4}	V _{DD} =3V, R2=2.2kΩ	0.070	0.100	0.130	V	G
Short detection voltage	V _{SHORT}	V _{DD} =3V	V _{DD} -1.2	V _{DD} -0.9	V _{DD} -0.6	V	F
Overcharge detection delay time	tV _{DET1}	V _{DD} =3.6V→4.4V	0.70	1.00	1.30	s	B
Overcharge release delay time	tV _{REL1}	V _{DD} =4.4V→3.6V	5.6	8.0	10.4	ms	B
Overdischarge detection delay time	tV _{DET2}	V _{DD} =3.6V→2.2V	67.2	96.0	124.8	ms	D
Overdischarge release delay time	tV _{REL2}	V _{DD} =3V, V ₋ =3V→0V	2.8	4.0	5.2	ms	E
Discharging overcurrent detection delay time	tV _{DET3}	V _{DD} =3V, V ₋ =0V→1V	8.4	12.0	15.6	ms	F
Discharging overcurrent release delay time	tV _{REL3}	V _{DD} =3V, V ₋ =3V→0V	2.8	4.0	5.2	ms	F
Charging overcurrent detection delay time	tV _{DET4}	V _{DD} =3V, V ₋ =0V→-1V	4.2	6.0	7.8	ms	G
Charging overcurrent release delay time	tV _{REL4}	V _{DD} =3V, V ₋ =-1V→0V	2.8	4.0	5.2	ms	G
Short detection delay time	t _{SHORT}	V _{DD} =3V, V ₋ =0V→3V	250	400	600	μs	F

Note: *1 The test circuit symbols.

*2 The all parameters on this page is guaranteed by design.

■ T_{OPR}=-30~70°C *2

Item	Symbol	Measurement conditions	Min.	Typ.	Max.	Units	*1
Overcharge detection voltage	V _{DET1}	R1=330Ω	4.255	4.300	4.345	V	B
Overcharge release voltage	V _{REL1}	R1=330Ω	4.030	4.100	4.170	V	B
Overcharge hysteresis voltage	V _{HYS1}	R1=330Ω, V _{HYS1} =V _{DET1} -V _{REL1}	0.130	0.200	0.270	V	B
Overdischarge detection voltage	V _{DET2}	V ₋ =0V, R1=330Ω	2.325	2.400	2.475	V	D
Overdischarge release voltage	V _{REL2}	V ₋ =0V, R1=330Ω	2.865	2.900	2.935	V	D
Discharging overcurrent detection voltage	V _{DET3}	V _{DD} =3V, R2=2.2kΩ	0.130	0.150	0.170	V	F
Charging overcurrent detection voltage	V _{DET4}	V _{DD} =3V, R2=2.2kΩ	0.060	0.100	0.140	V	G
Short detection voltage	V _{SHORT}	V _{DD} =3V	V _{DD} -1.2	V _{DD} -0.9	V _{DD} -0.6	V	F
Overcharge detection delay time	tV _{DET1}	V _{DD} =3.6V→4.4V	0.6	1.00	1.50	s	B
Overcharge release delay time	tV _{REL1}	V _{DD} =4.4V→3.6V	4.8	8.0	12.0	ms	B
Overdischarge detection delay time	tV _{DET2}	V _{DD} =3.6V→2.2V	57.6	96.0	144.0	ms	D
Overdischarge release delay time	tV _{REL2}	V _{DD} =3V, V ₋ =3V→0V	2.4	4.0	6.0	ms	E
Discharging overcurrent detection delay time	tV _{DET3}	V _{DD} =3V, V ₋ =0V→1V	7.2	12.0	18.0	ms	F
Discharging overcurrent release delay time	tV _{REL3}	V _{DD} =3V, V ₋ =3V→0V	2.4	4.0	6.0	ms	F
Charging overcurrent detection delay time	tV _{DET4}	V _{DD} =3V, V ₋ =0V→-1V	3.6	6.0	9.0	ms	G
Charging overcurrent release delay time	tV _{REL4}	V _{DD} =3V, V ₋ =-1V→0V	2.4	4.0	6.0	ms	G
Short detection delay time	t _{SHORT}	V _{DD} =3V, V ₋ =0V→3V	200	400	800	μs	F

Note: *1 The test circuit symbols.

*2 The all parameters on this page is guaranteed by design.

Measuring Circuit

■ A

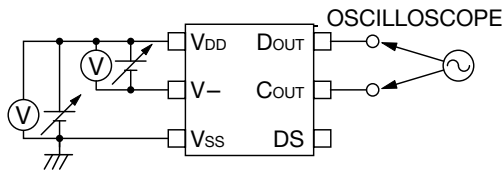

■ H

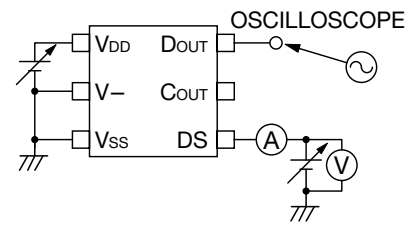

■ B

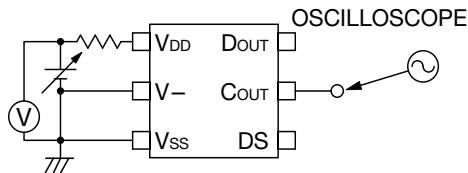

■ I

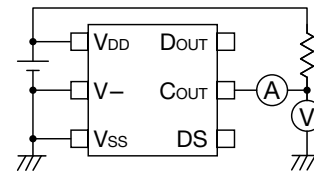

■ C

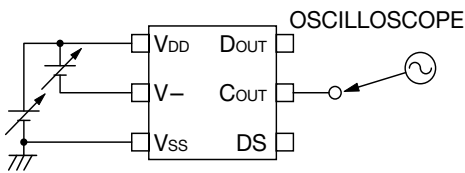

■ J

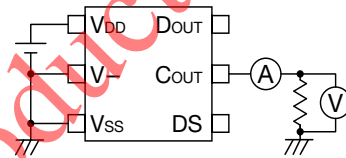

■ D

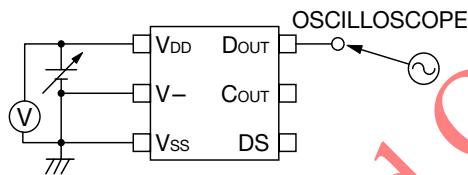

■ K

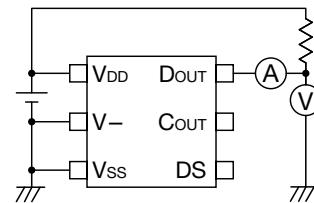

■ E

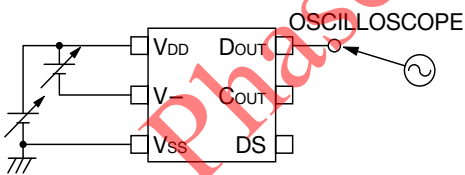

■ L

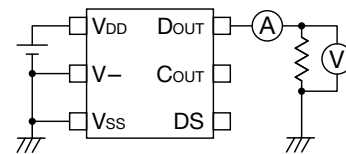

■ F

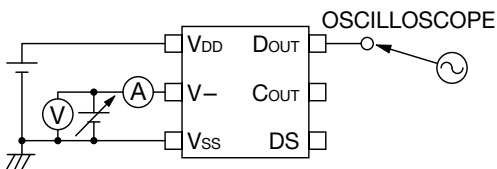

■ M

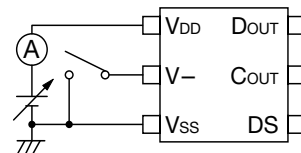

■ G

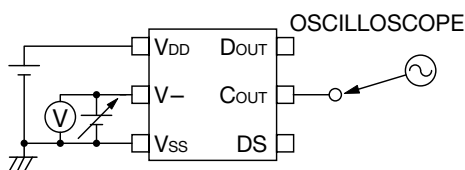

Application Circuit

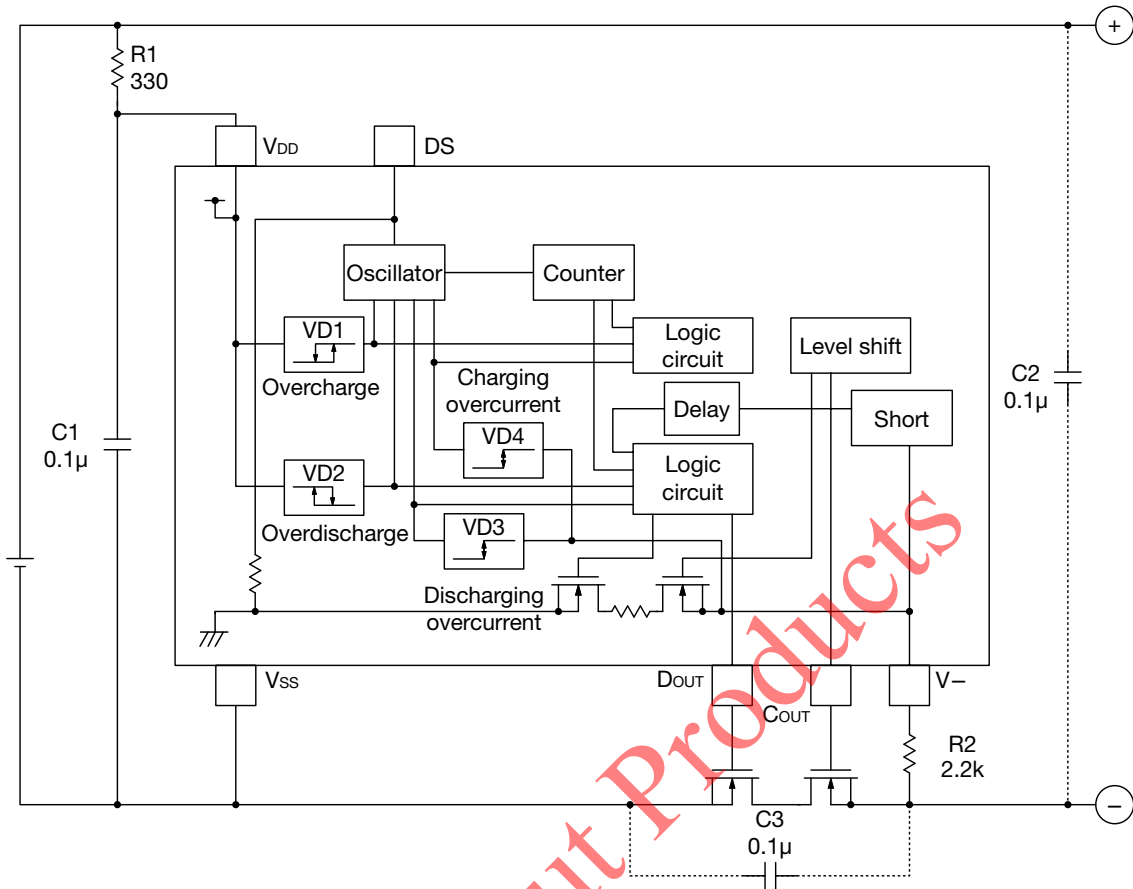

Application hints

R1 and C1 stabilize a supply voltage ripple. However, the detection voltage rises by the current of penetration in IC of the voltage detection when R1 is enlarged, and the value of R1 is adjusted to 1kΩ or less. Moreover, adjust the value of C1 to 0.01μF or more to do the stability operation, please.

R1 and R2 resistors are current limit resistance if a charger is connected reversibly or a highvoltage charger that exceeds the absolute maximum rating is connected. R1 and R2 may cause a power consumption will be over rating of power dissipation, therefore the R1+R2 should be more than 1kΩ. Moreover, if R2 is too enlarged, the charger connection release cannot be occasionally done after the overdischarge is detected, so adjust he value of R2 to 10kΩ or less, please.

C2 and C3 capacitors have effect that the system stability about voltage ripple or imported noise. After check characteristics, decide that these capacitors should be inserted or not, where should be inserted, and capacitance value, please.