

# 300mA LDO with thermal shutdown Monolithic IC MM3608 Series

## Outline

This IC is a 300mA LDO with thermal shut-down.

The overcurrent protection is included, It is prevented to destroy IC by sensing extraordinary thermal and shut-down output voltage.

## Features

- |                                      |  |
|--------------------------------------|--|
| 1. Input voltage range               | 1.8V to 6.5V   |
| 2. Output voltage range              | 0.8V to 5.0V   |
| 3. Output voltage accuracy           | $V_{OUT} \pm 1\%$ ( $V_o \geq 2.0V$ )                      |
| 4. Maximum output current            | 300mA  |
| 5. Current consumption               | 0.1 $\mu$ A typ. (OFF)<br>90 $\mu$ A typ. (No-Load)        |
| 6. Dropout voltage                   | 0.24V typ. / 0.39V max. ( $I_o=300mA$ , $V_o=3.0$ to 5.0V) |
| 7. Line regulation                   | 0.02%/V typ.<br>0.1%/V max. ( $I_o=1mA$ )                  |
| 8. Load regulation                   | 10mV typ.<br>60mV max. ( $I_o=1mA$ to 300mA)               |
| 9. $V_{OUT}$ Temperature coefficient | $\pm 100ppm/^{\circ}C$ typ.                                |
| 10. TSD detect temperature           | 150 $^{\circ}C$ typ.                                       |
| 11. TSD release temperature          | 110 $^{\circ}C$ typ.                                       |
| 12. Output capacitor                 | 1 $\mu$ F (ceramic)  |

## Package

SOT-25A

## Applications

1. Flat-TV
2. BD Player/ Recorders
3. PCs
4. Games

## Block Diagram

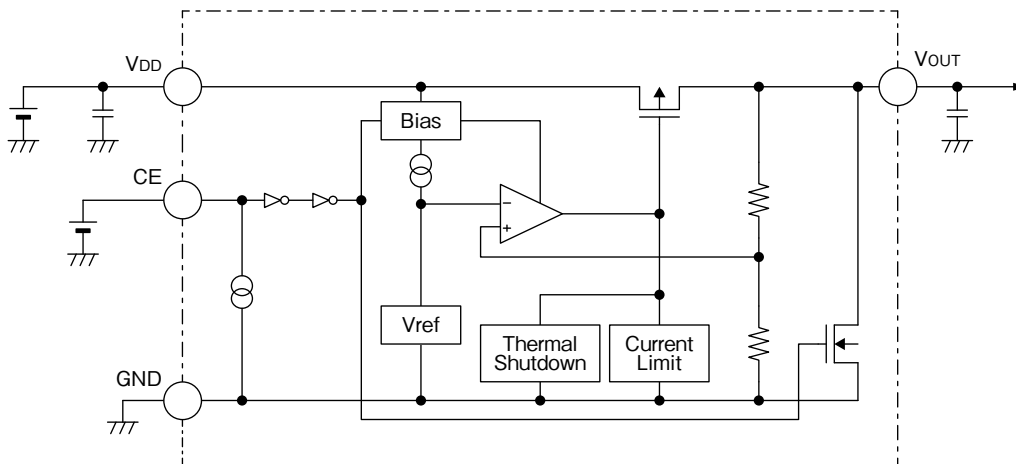

## Pin Assignment

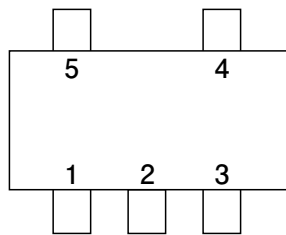

SOT-25A  
(TOP VIEW)

1	V <sub>DD</sub>
2	GND
3	CE
4	NC
5	V <sub>OUT</sub>

## Pin Description

Pin No.	Pin name	Functions						
1	V <sub>DD</sub>	Voltage supply pin						
2	GND	Ground pin						
3	CE	ON/OFF-Control pin <table border="1" style="margin-left: 20px;"> <tr> <td>CE</td> <td>Output</td> </tr> <tr> <td>L</td> <td>OFF</td> </tr> <tr> <td>H</td> <td>ON</td> </tr> </table> <p>Connect CE pin with V<sub>DD</sub> pin, when it is not used.</p>	CE	Output	L	OFF	H	ON
CE	Output							
L	OFF							
H	ON							
4	NC	No connection						
5	V <sub>OUT</sub>	Output pin						

## Absolute Maximum Ratings (Except where noted otherwise Ta=25°C)

Item	Symbol	Ratings	Units
Storage temperature	T <sub>stg</sub>	-55 to +125	°C
Junction temperature	T <sub>jMAX</sub>	125	
Supply voltage	V <sub>DD</sub>	-0.3 to +7.0	V
CE input voltage	V <sub>CE</sub>	-0.3 to +7.0	
Output voltage	V <sub>OUT</sub>	-0.3 to V <sub>DD</sub> +0.3	
Output current	I <sub>OMAX</sub>	500	mA
Power Dissipation 1 (Note1)	P <sub>d1</sub>	280	mW
Power Dissipation 2 (Note2)	P <sub>d2</sub>	560	

Note1 : With PC Board of glass epoxy 60mm×40mm×1.6mm

Note2 : JEDEC51-7 Standard 114.3mm×76.2mm, t=1.6mm

## Recommended Operating Conditions

Item	Symbol	Ratings	Units
Operating Ambient temperature	T <sub>opr</sub>	-40 to +85	°C
Operating junction temperature (Note3)	T <sub>jop</sub>	125	
Operating voltage	V <sub>op</sub>	1.8 to 6.5	V
Output current	I <sub>OUT</sub>	0 to 300	mA

Note3 : In consideration of product life, please examine the use in less than 80% of T<sub>jMAX</sub>.

## Electrical Characteristics 1 (Except where noted otherwise V<sub>DD</sub>=V<sub>OUT</sub>(typ.)+1V, V<sub>CE</sub>=V<sub>DD</sub>, Ta=25°C)

Item	Symbol	Measurement conditions	Min.	Typ.	Max.	Units
Input current consumption (OFF)	I <sub>DDOFF</sub>	V <sub>CE</sub> =0V		0.1	1.0	μA
No-Load input current consumption	I <sub>DD</sub>	I <sub>OUT</sub> =0mA		90	140	
Output voltage	V <sub>OUT</sub>	I <sub>OUT</sub> =1mA (V <sub>OUT</sub> ≥2V)	×0.99		×1.01	V
		I <sub>OUT</sub> =1mA (V <sub>OUT</sub> <2V)	-0.020		+0.020	
Line regulation	V <sub>LINE</sub>	1.8V≤V <sub>DD</sub> ≤6.5V, I <sub>OUT</sub> =1mA, V <sub>OUT</sub> ≤1.3V		0.02	0.10	% / V
		V <sub>OUT</sub> (typ.) +0.5V≤V <sub>DD</sub> ≤6.5V, I <sub>OUT</sub> =1mA, 1.3V<V <sub>OUT</sub>				
Load regulation	V <sub>LOAD</sub>	1mA≤I <sub>OUT</sub> ≤300mA		10	60	mV
Dropout voltage	V <sub>io</sub>	Please refer to another page				V
Output short-circuit current (Note4)	I <sub>short</sub>	V <sub>OUT</sub> =0V		200		mA
Vout temperature coefficient (Note4)	ΔV <sub>OUT</sub> /ΔT	-40≤T <sub>op</sub> ≤+85°C, I <sub>OUT</sub> =1mA		±100		ppm/°C
Ripple rejection	RR	f=1kHz, V <sub>ripple</sub> =0.5V, I <sub>OUT</sub> =30mA		70		dB
CE High threshold voltage	V <sub>CEH</sub>		1.5		6.5	V
CE Low threshold voltage	V <sub>CEL</sub>				0.3	
CE Pin current (Note4)	I <sub>CE</sub>			0.15		μA
Output NMOS ON resistance (Note4)	R <sub>DON</sub>	V <sub>CE</sub> =0V		20		Ω
Thermal shutdown detect temperature (Note4)	T <sub>SD</sub>			150		°C
Thermal shutdown release temperature (Note4)	T <sub>SR</sub>			110		

Note4 : The parameter is guaranteed by design.

**Electrical Characteristics 2** (Except where noted otherwise  $V_{DD}=V_{OUT}(typ.)+1V$ ,  $V_{CE}=V_{DD}$ ,  $T_a=25^{\circ}C$ )

Output voltage $V_{OUT}$ (V)	Item							
	Output voltage				Dropout Voltage			
	$V_{OUT}$ (V)				$V_{io}$ (mV)			
	Measurement Conditions	Min.	Typ.	Max.	Measurement Conditions	Min.	Typ.	Max.
0.80	$I_{OUT}=1mA$	0.780	0.800	0.820	$I_{OUT}=300mA,$ $0.8V \leq V_{OUT} < 2.0V$ (Note5)		850	1250
0.90		0.880	0.900	0.920				
1.00		0.980	1.000	1.020			720	1080
1.10		1.080	1.100	1.120				
1.20		1.180	1.200	1.220			630	920
1.30		1.280	1.300	1.320				
1.40		1.380	1.400	1.420			550	810
1.50		1.480	1.500	1.520				
1.60		1.580	1.600	1.620				
1.70		1.680	1.700	1.720				
1.80		1.780	1.800	1.820			500	740
1.90		1.880	1.900	1.920				
2.00		1.980	2.000	2.020				
2.10		2.079	2.100	2.121				
2.20		2.178	2.200	2.222			400	600
2.30		2.277	2.300	2.323				
2.40		2.376	2.400	2.424				
2.50		2.475	2.500	2.525				
2.60		2.574	2.600	2.626				
2.70		2.673	2.700	2.727				
2.80		2.772	2.800	2.828		310	500	
2.85		2.822	2.850	2.879				
2.90		2.871	2.900	2.929				
3.00		2.970	3.000	3.030				
3.10		3.069	3.100	3.131				
3.20		3.168	3.200	3.232				
3.30		3.267	3.300	3.333				
3.40		3.366	3.400	3.434	$I_{OUT}=300mA,$ $2.0V \leq V_{OUT} \leq 5.0V,$ $V_{DD}=V_{OUT}(TYP.)-0.2V$			
3.50		3.465	3.500	3.535				
3.60		3.564	3.600	3.636				
3.70	3.663	3.700	3.737					
3.80	3.762	3.800	3.838					
3.90	3.861	3.900	3.939					
4.00	3.960	4.000	4.040			240	390	
4.10	4.059	4.100	4.141					
4.20	4.158	4.200	4.242					
4.30	4.257	4.300	4.343					
4.40	4.356	4.400	4.444					
4.50	4.455	4.500	4.545					
4.60	4.554	4.600	4.646					
4.70	4.653	4.700	4.747					
4.80	4.752	4.800	4.848					
4.90	4.851	4.900	4.949					
5.00	4.950	5.000	5.050					

Note5 : Dropout voltage maximum value in the input and it is confirmed that there is no output abnormal voltage impression the 300mA in the model less than  $V_{OUT}<2.0V$ .

• Any products mentioned in this catalog are subject to any modification in their appearance and others for improvements without prior notification.  
 • The details listed here are not a guarantee of the individual products at the time of ordering. When using the products, you will be asked to check their specifications.

## Measuring Circuit

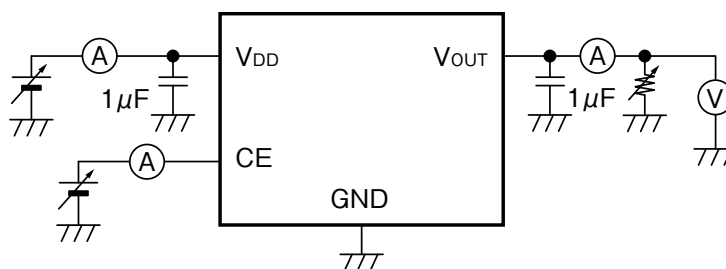

## Application Circuit

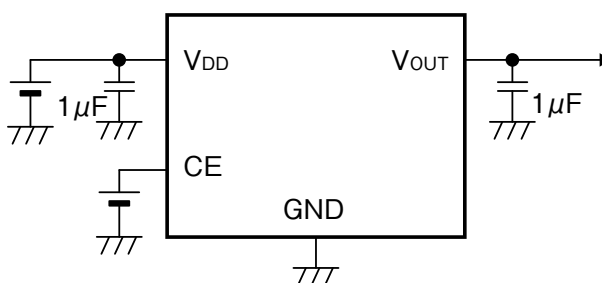

(Reference example of external parts)

- Output capacitor                      Ceramic capacitor 1µF                      \*Temperature Characteristics : B
- Input capacitor                        Ceramic capacitor 1µF                      \*Temperature Characteristics : B

· In the event a problem which may affect industrial property or any other rights of us or a third party is encountered during the use of information described in these circuit, we shall not be liable for any such problem, nor grant a license therefore.

NOTE

1. There is a possibility with deterioration and destruction of IC when using it exceeding the absolute maximum rating. The absolute maximum rating, Never exceed it.  
The functional operation is not assured.
2. There is a possibility that it becomes impossible to maintain this performance and reliability IC original when using it exceeding recommended operation voltage.  
Please use it in recommended operation voltage.
3. Due to restrictions on the package power dissipation, the output current value may not be satisfied.  
Attention should be paid to the power dissipation of the package when the output current is large or the voltage between Input and Output is high.
4. The output capacitor is required between output and GND to prevent oscillation.
5. The ESR of capacitor must be defined in ESR stability area.  
It is possible to use a ceramic capacitor without ESR resistance for output.  
The ceramic capacitor must be used more than  $1.0\mu\text{F}$  and B temperature characteristics.
6. The wire of VDD and GND is required to print full ground plane for noise and stability.
7. The input capacitor must be connected a distance of less than 1 cm from input pin.
8. In case the output voltage is above the input voltage, the overcurrent flow by internal parasitic diode from output to input.  
In such application, the external bypass diode must be connected between output and input pin.

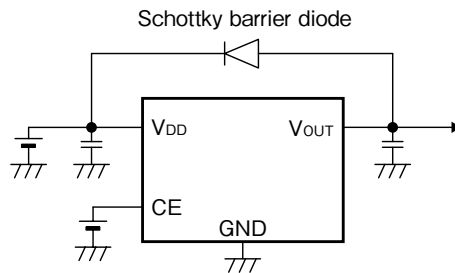

9. It is able to an unstable operation when you use the capacitor with intense capacitance change.  
The capacitor has the dependency at the power-supply voltage and the temperature.  
The capacity value changes by the environment used. Please evaluate IC in the set.
10. The overcurrent protection circuit of foldback current limit type is built into this IC.
11. There is a possibility that IC generates heat when the output terminal is short-circuited.  
However, the thermal shutdown circuit operates, and it will do operation that protects IC.  
The thermal shutdown circuit is designed only to shut the IC off to prevent thermal runaway.  
Do not continue to use the IC in an environment where the operation of this circuit is assumed.  
The characteristic changes depending on the substrate condition.  
Please evaluate IC in the set.
12. It returns automatically in temperature returned after it shuts down by self-generation of heat.  
After it returns, it shuts down again by self-generation of heat. It is necessary to change the environment used (IC consumption, temperature) if it operates in upper cycle.
13. When VDD(CE) of low output voltage rank is OFF→ON, the overshoot(about 0.1V) of VOUT is generated. Please evaluate IC in the set.
14. If transitional change for VDD terminal voltage is large after output voltage is stable, it is possible that thermal shutdown malfunction.  
So it should be used that change of VDD terminal voltage is under  $0.15\text{V}/\mu\text{s}$ .

## About Power Dissipation

The Power dissipation change if board to mount IC change because radiative heat fix at board. It is reference data below, Evaluate IC in the set.

1. JEDEC51-7 standard

Board size 114.3mm×76.2mm t=1.6mm Copper foil area 80%  
 Power dissipation 560mW Ta=25°C (It is reference value measured by JEDEC51-7 standard.)

2. Spec. sheet condition

Board size 60mm×40mm t=1.6mm Copper foil area 60%  
 Power dissipation 280mW Ta=25°C

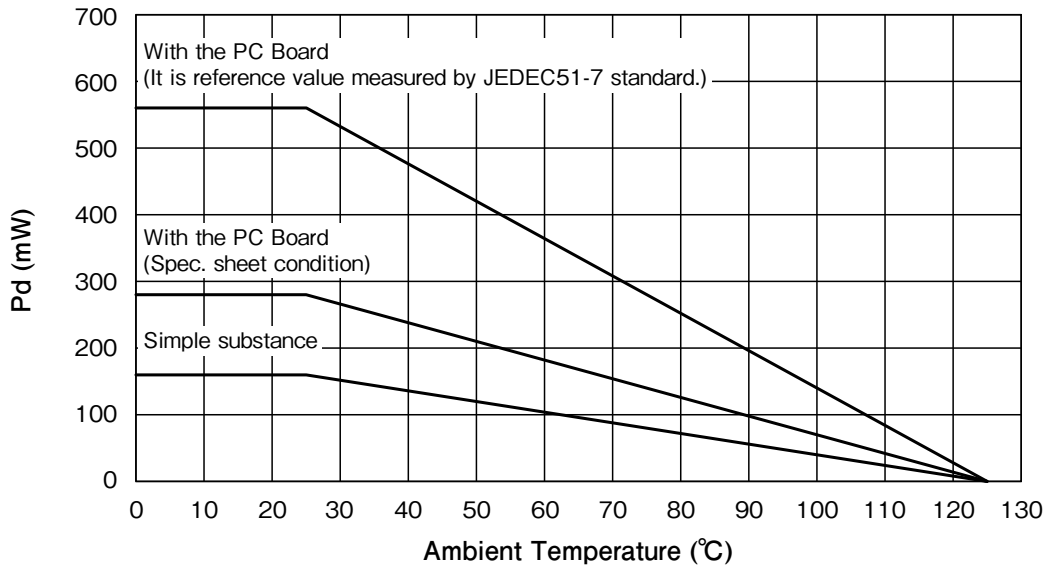

Condition of temperature and input voltage, output current should be used in enough margin concerning power dissipation. In consideration of product life, recommend to use in less than 80%.

It is recommended to layout the VIA for heat radiation in the GND pattern of reverse (of IC) when there is the GND pattern in the inner layer (in using multilayer substrate).

By increasing these copper foil pattern area of PCB, Power dissipation improves.

**Characteristics (0.8V)**

(Except where noted otherwise  $V_{DD}=V_{OUT}(typ.)+1V$ ,  $V_{CE}=V_{DD}$ ,  $T_a=25^{\circ}C$ )

**Input voltage - Output voltage**

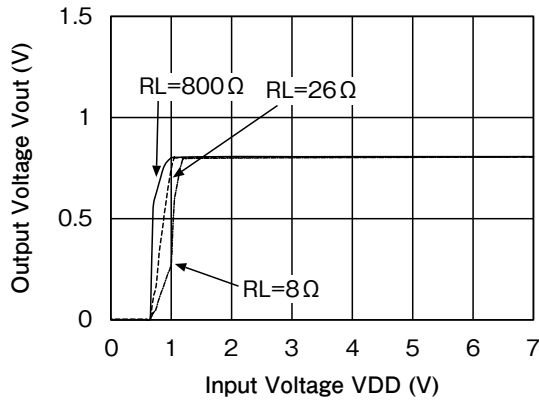

**Input voltage - Input current**

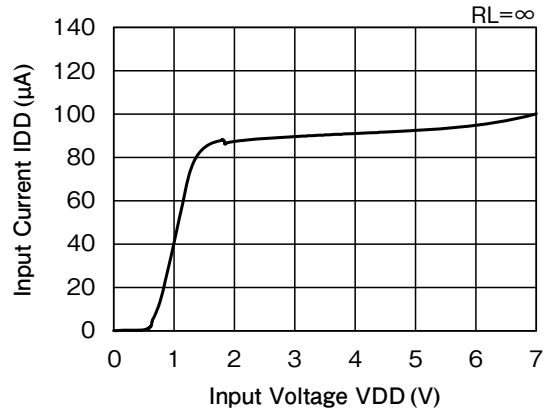

**Load regulation**

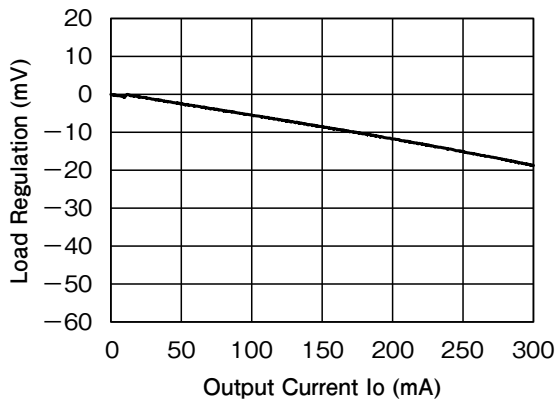

**Line regulation**

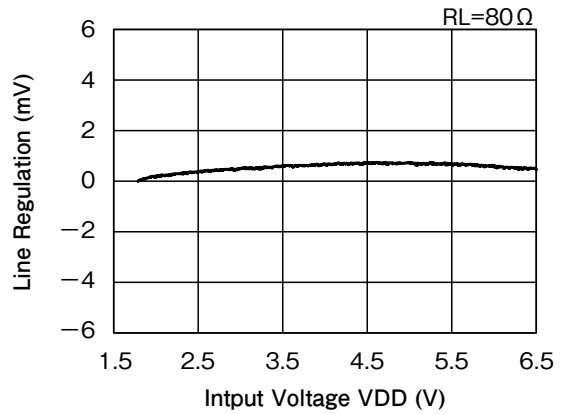

**$V_{OUT}$  temperature coefficient**

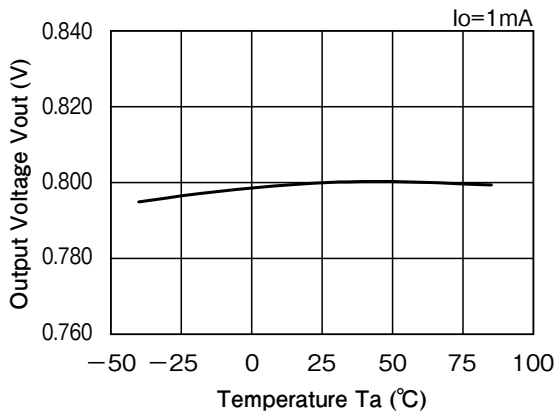

• Any products mentioned in this catalog are subject to any modification in their appearance and others for improvements without prior notification.  
 • The details listed here are not a guarantee of the individual products at the time of ordering. When using the products, you will be asked to check their specifications.



**Ripple Rejection**

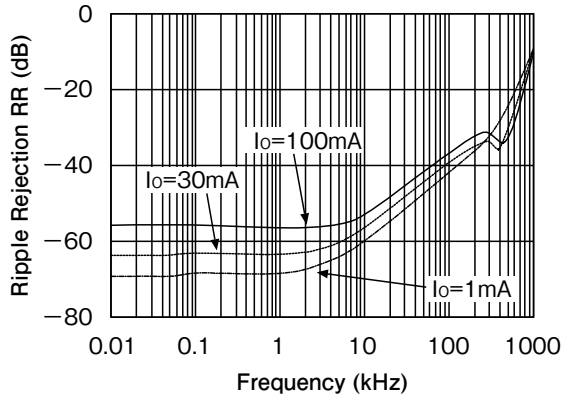

**ESR stable area**

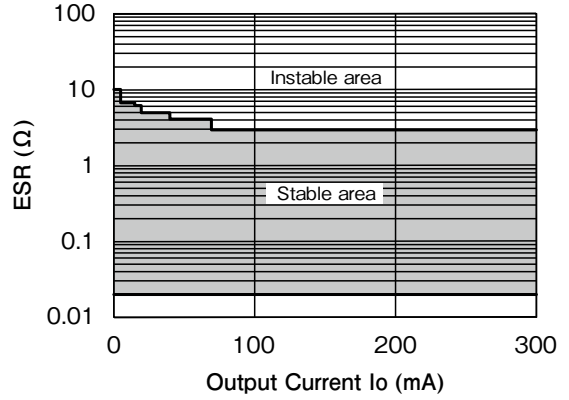

**Current limit**

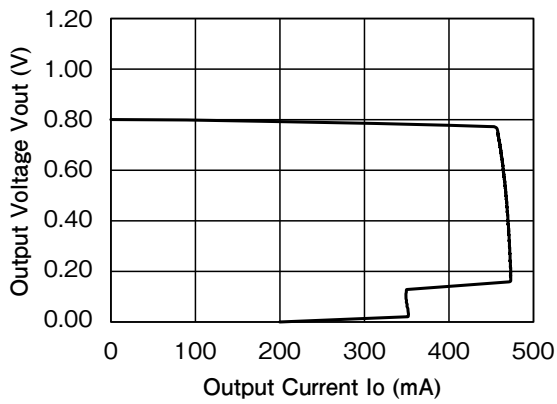

**CE pin voltage - CE pin current**

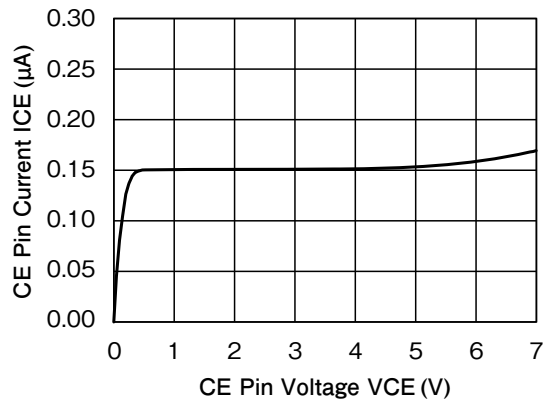

■ Load transient response  
( $C_{in}=C_{out}=1\mu F$ )

$I_o=1mA \leftrightarrow 50mA$

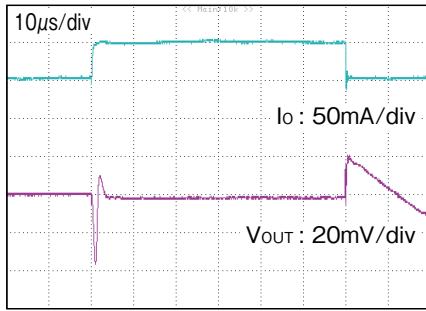

$I_o=1mA \leftrightarrow 300mA$

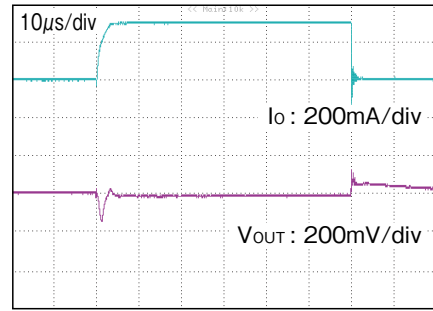

$I_o=10mA \leftrightarrow 300mA$

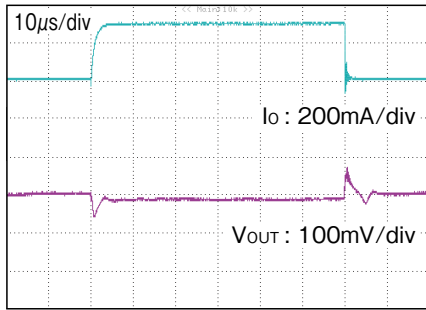

$I_o=50mA \leftrightarrow 300mA$

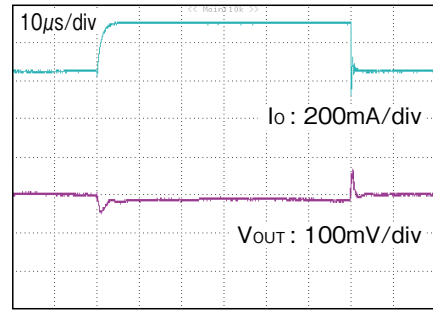

■ Turn - On transient response

$V_{DD}=1.8V, V_{CE}=0V \rightarrow V_{DD}, C_{in}=C_{o}=1\mu F, R_L=800\Omega$

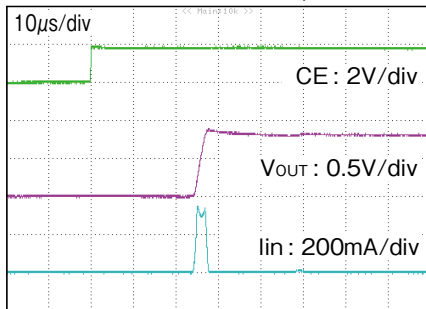

■ Turn - Off transient response

$V_{DD}=1.8V, V_{CE}=V_{DD} \rightarrow 0V, C_{in}=C_{o}=1\mu F, R_L=800\Omega$

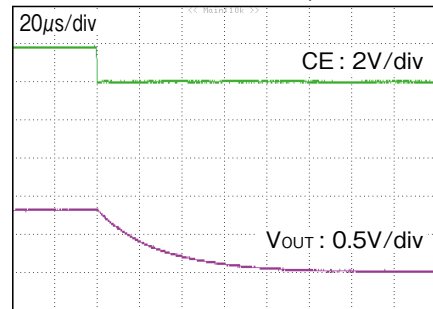

**Characteristics (3.0V)**

(Except where noted otherwise  $V_{DD}=V_{OUT}(typ.)+1V$ ,  $V_{CE}=V_{DD}$ ,  $T_a=25^{\circ}C$ )

**Input voltage - Output voltage**

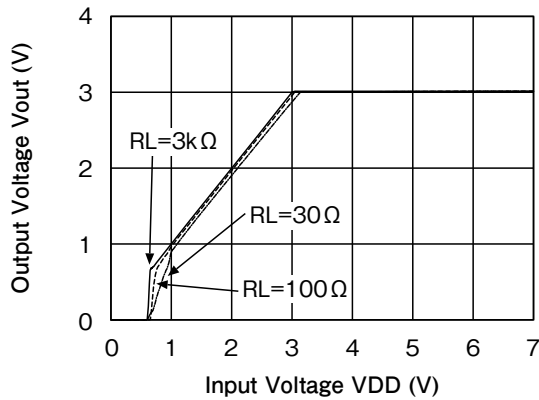

**Input voltage - Input current**

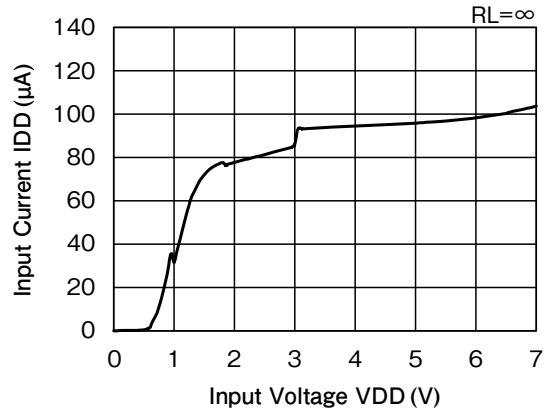

**Load regulation**

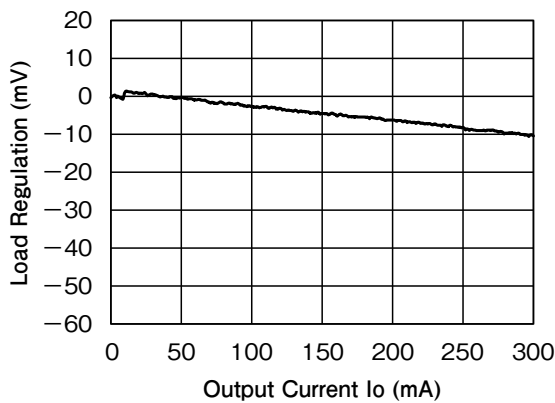

**Line regulation**

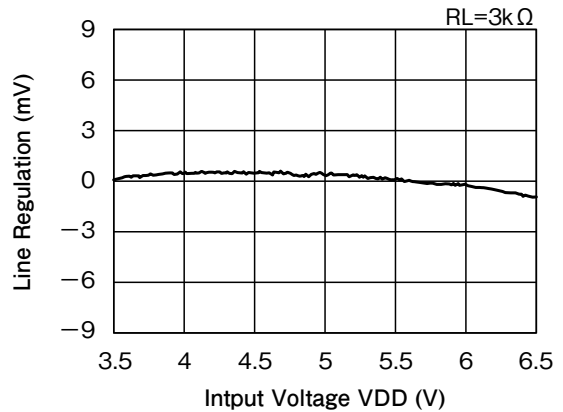

**VOUT temperature coefficient**

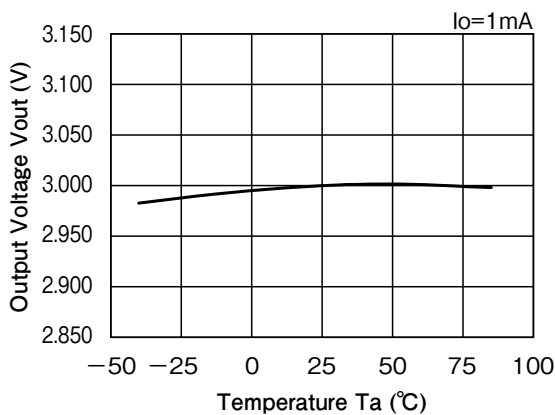

**Dropout voltage**

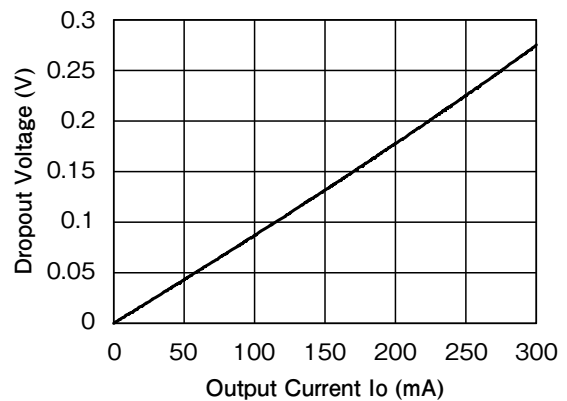

• Any products mentioned in this catalog are subject to any modification in their appearance and others for improvements without prior notification.  
 • The details listed here are not a guarantee of the individual products at the time of ordering. When using the products, you will be asked to check their specifications.

■ Ripple Rejection

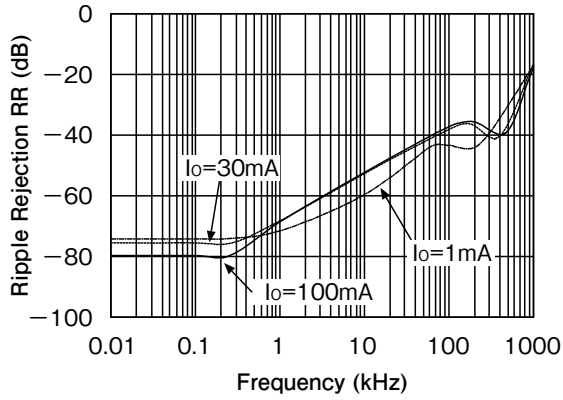

■ ESR stable area

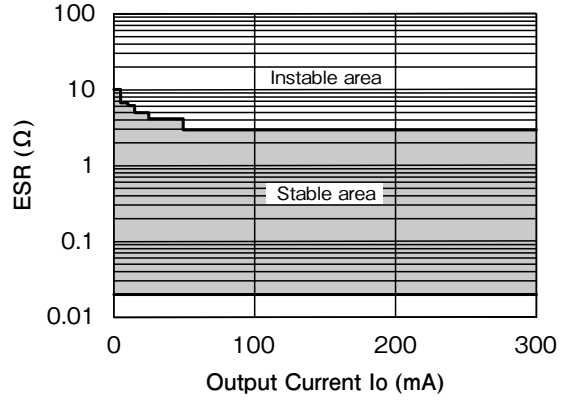

■ Current limit

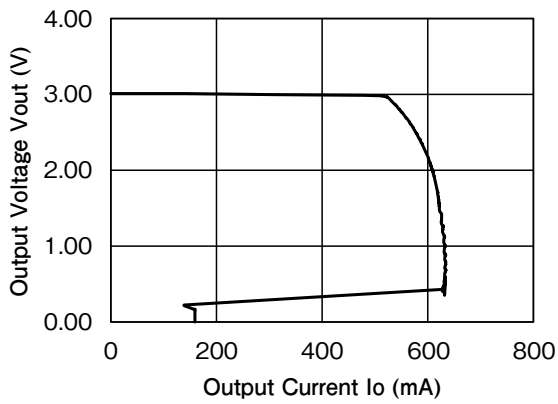

■ CE pin voltage - CE pin current

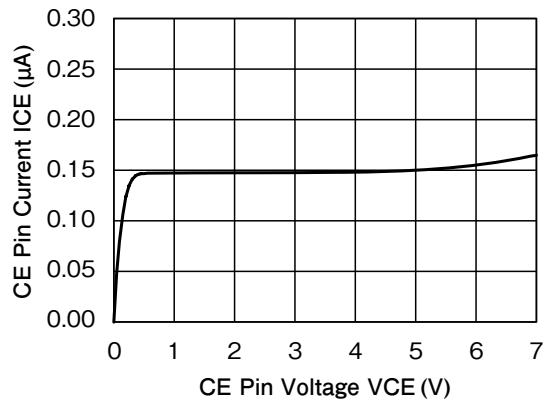

■ Load transient response  
( $C_{in}=C_{out}=1\mu F$ )

$I_o=1mA \leftrightarrow 50mA$

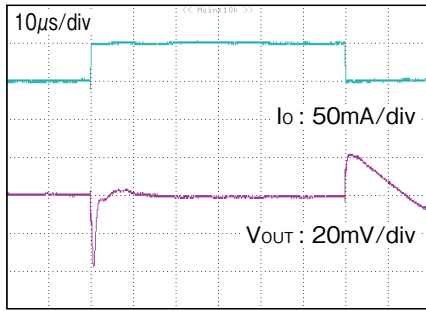

$I_o=1mA \leftrightarrow 300mA$

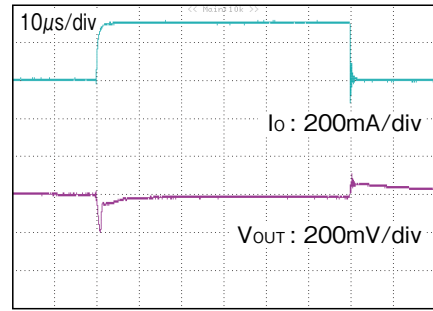

$I_o=10mA \leftrightarrow 300mA$

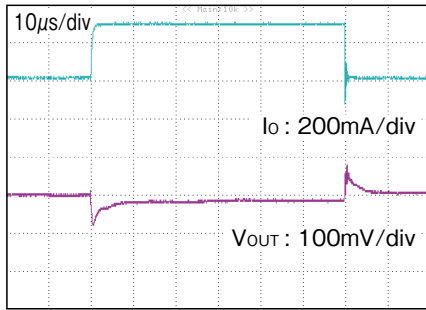

$I_o=50mA \leftrightarrow 300mA$

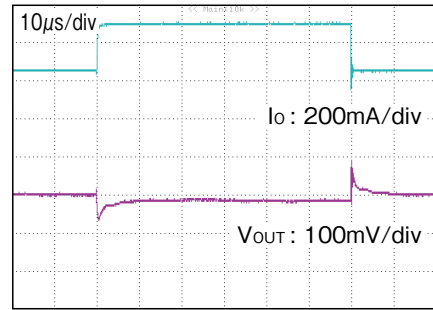

■ Turn - On transient response

$V_{DD}=4.0V, V_{CE}=0V \rightarrow V_{DD}, C_{in}=C_o=1\mu F, R_L=3k\Omega$

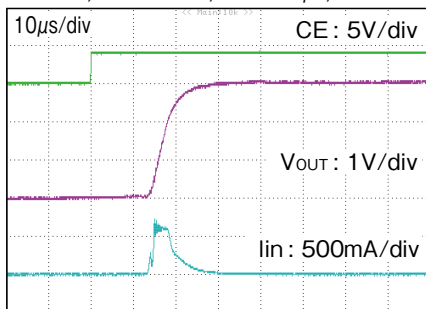

■ Turn - Off transient response

$V_{DD}=4.0V, V_{CE}=V_{DD} \rightarrow 0V, C_{in}=C_o=1\mu F, R_L=3k\Omega$

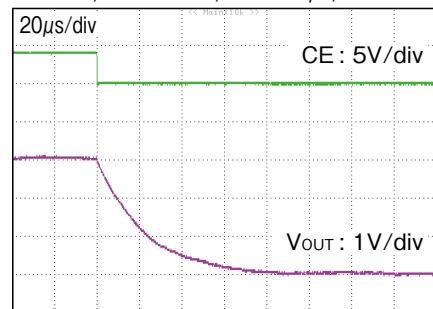

**Characteristics (5.0V)**

(Except where noted otherwise  $V_{DD}=V_{OUT}(typ.)+1V$ ,  $V_{CE}=V_{DD}$ ,  $T_a=25^{\circ}C$ )

**Input voltage - Output voltage**

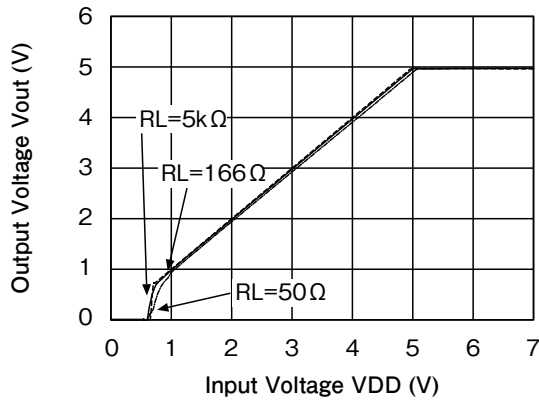

**Input voltage - Input current**

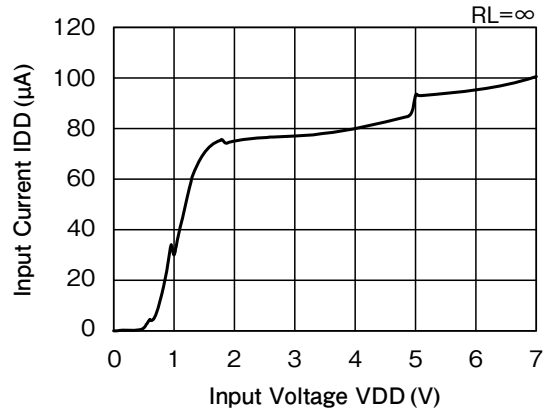

**Load regulation**

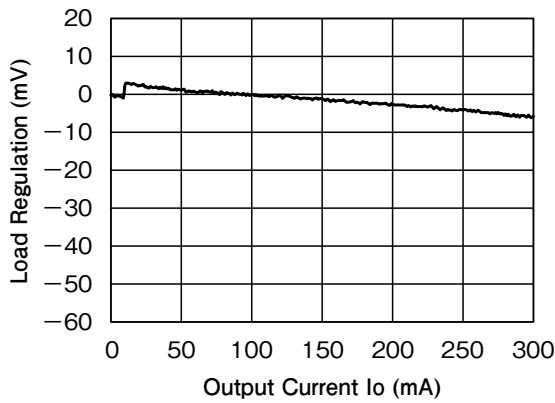

**Line regulation**

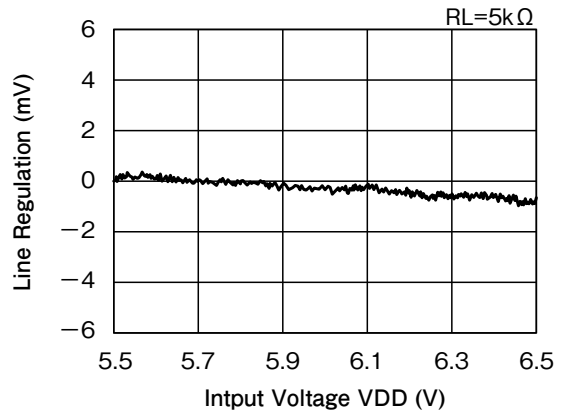

**VOUT temperature coefficient**

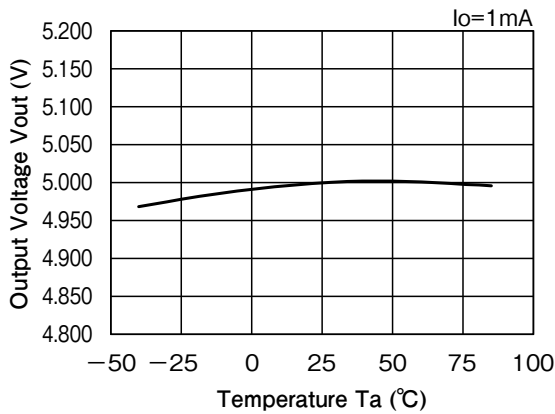

**Dropout voltage**

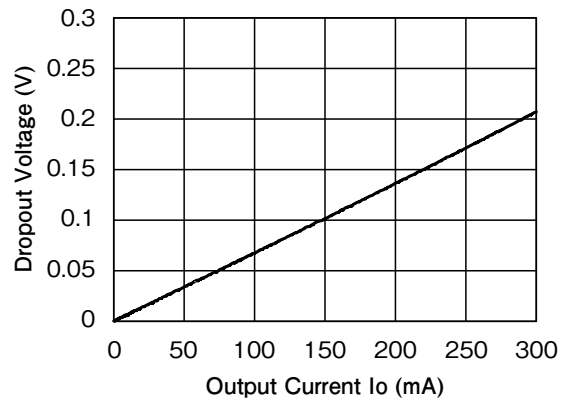

• Any products mentioned in this catalog are subject to any modification in their appearance and others for improvements without prior notification.  
 • The details listed here are not a guarantee of the individual products at the time of ordering. When using the products, you will be asked to check their specifications.

**Ripple Rejection**

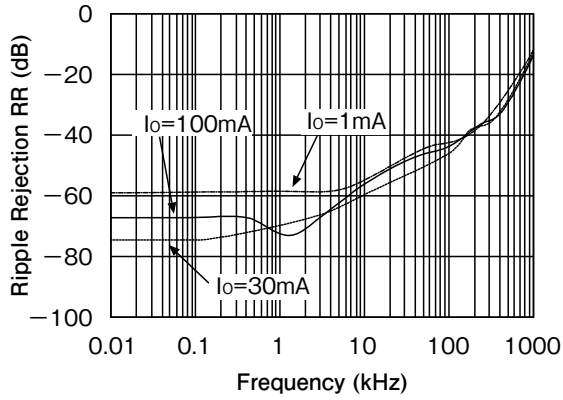

**ESR stable area**

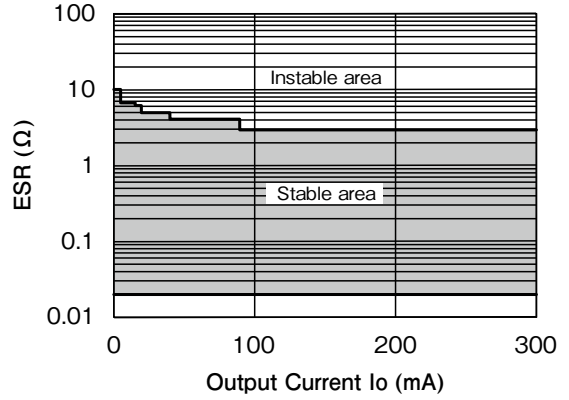

**Current limit**

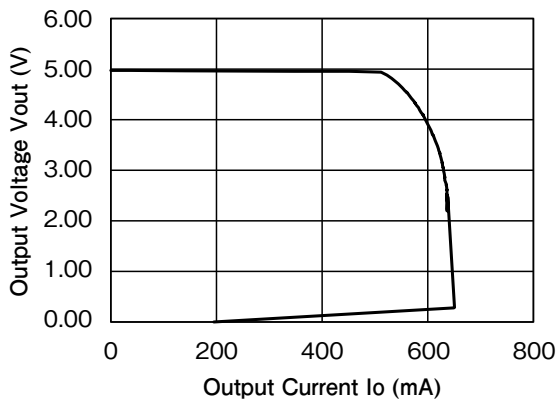

**CE pin voltage - CE pin current**

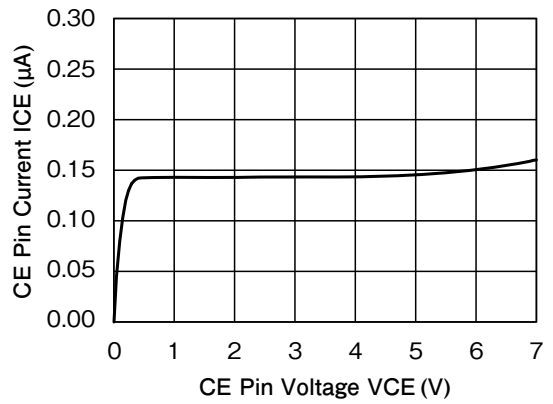

■ Load transient response  
( $C_{in}=C_{out}=1\mu F$ )

$I_o=1mA \leftrightarrow 50mA$

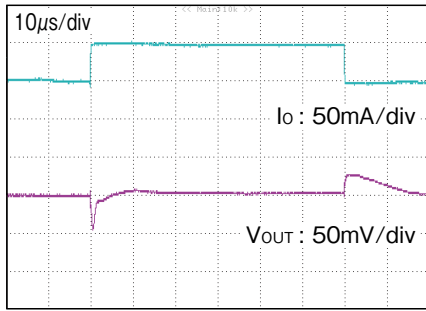

$I_o=1mA \leftrightarrow 300mA$

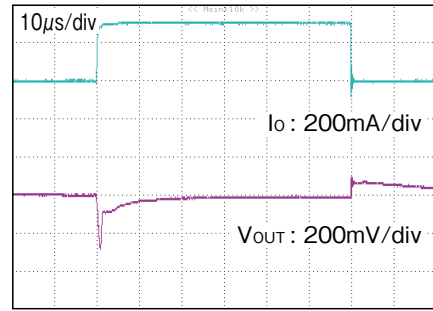

$I_o=10mA \leftrightarrow 300mA$

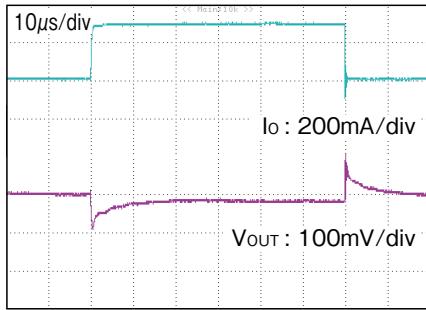

$I_o=50mA \leftrightarrow 300mA$

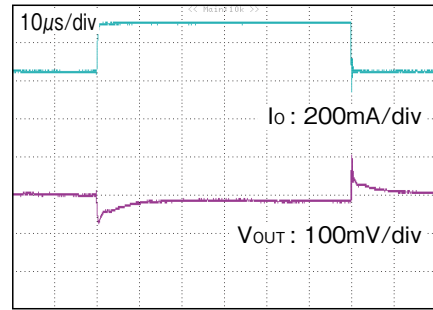

■ Turn - On transient response

$V_{DD}=6.0V, V_{CE}=0V \rightarrow V_{DD}, C_{in}=C_{o}=1\mu F, R_L=5k\Omega$

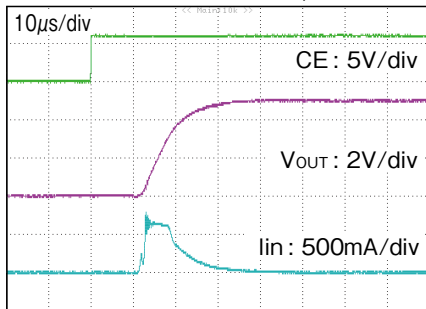

■ Turn - Off transient response

$V_{DD}=6.0V, V_{CE}=V_{DD} \rightarrow 0V, C_{in}=C_{o}=1\mu F, R_L=5k\Omega$

