



Soft start function 500mA LDO

MM3823 Series

Overview

This IC is a 500mA LDO with soft start. The soft start function can optionally set output rise time by an external capacitor Cs.

Features

- Soft start (programmable)

Main specifications

($V_{DD}=V_{OUT(Typ.)}+1V$, $V_{CE}=V_{DD}$, $T_a=25^{\circ}C$ unless otherwise specified)

- Maximum rating supply voltage : -0.3V to 7V
- Operating voltage range : 1.6V to 6.5V
- Operating ambient temperature : -40°C to 85°C
- Output current : 500mA
- Input current (OFF) : Typ. 0.1uA
- No-load input current : Typ. 60uA
- Output voltage range : 1V to 5V (0.1V step)
- Output voltage accuracy : $\pm 1\%$ ($1.5V \leq V_{OUT(Typ.)}$)
 $\pm 15mV$ ($V_{OUT(Typ.)} < 1.5V$)
- Line regulation : Typ. 0.05%/V ($2.0V \leq V_{OUT(Typ.)}$, $V_{DD}=V_{OUT(Typ.)}+0.5V$ to 6.5V)
Typ. 0.05%/V ($V_{OUT} < 2.0V(Typ.)$, $V_{DD}=2.5V$ to 6.5V)
- Load regulation : Typ. 15mV ($I_{OUT}=1mA$ to 200mA)
- Dropout voltage : Typ. 0.25V ($I_{OUT}=500mA$, $V_{OUT(Typ.)}=3V$)
- PSRR : Typ. 70dB ($V_{OUT(Typ.)} < 1.3V$, $f=1kHz$)
Typ. 65dB ($1.3V \leq V_{OUT(Typ.)} < 3.4V$, $f=1kHz$)
Typ. 60dB ($3.4V \leq V_{OUT(Typ.)}$, $f=1kHz$)
- Output capacitor : 1uF (Ceramic capacitor)
- Protection function : Over current protection, Thermal shutdown
- Additional function : ON/OFF control, Auto discharge, Soft start

Packages

- SOT-25A

Application

- Audio visual equipment
- Portable communication device
- Photographing / Imaging device
- Wearable device





Model Name

Series name (A) (B) (C) (D) (E)

(A)	Function Type	A	CE=H active, with discharge function
(B)	Output voltage rank	10	The output voltage can be designated in the range from 1.0V(10) to 5.0V(50) in 0.1V steps.
		?	
		50	
(C)	Package	N	SOT-25A
(D)	Packing specifications 1	R	R housing
(E)	Packing specifications 2	H	Embos tape / Pb free / Halogen free

Block Diagram

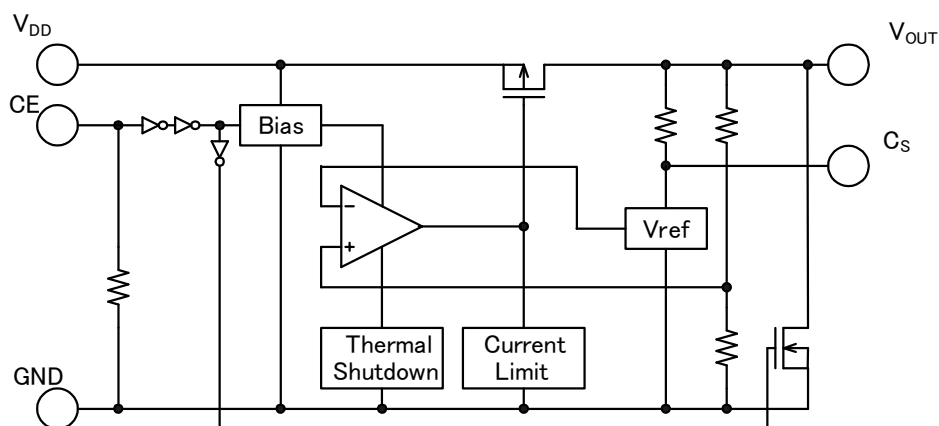



Pin Configuration

- SOT-25A

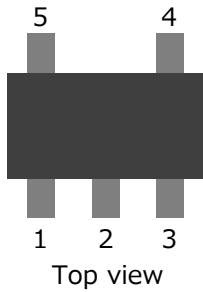

Pin No.	Pin name	Function
1	C_S	Soft-start pin Must be connect capacitor to Soft-start pin.
2	GND	GND pin
3	CE	ON/OFF-control pin Connect CE pin with VDD pin, when it is not used.
4	V_{DD}	Voltage supply pin
5	V_{OUT}	Output pin





Absolute Maximum Ratings

Item	Symbol	Min.	Max.	Unit
保存温度	Tstg	-55	150	°C
接合温度	T _{JMAX}	-	150	°C
電源電圧	V _{DD}	-0.3	7.0	V
CE入力電圧	V _{CE}	-0.3	7.0	V
出力電圧	V _{OUT}	-0.3	V _{DD} +0.3	V
出力電圧	V _{OUT}	-0.3	V _{DD} +0.3	V
出力電流	I _{OUT}	-	600	mA
許容損失 *Note1	Pd	-	700	mW

*Note1:JEDEC51-7 standard

Recommended Operating Conditions

Item	Symbol	Min.	Max.	Unit
動作接合温度	T _{jopr}	-40	125	°C
動作周囲温度	T _{opr}	-40	85	°C
入力電圧	V _{op}	1.6	6.5	V
出力電流	I _{OUT}	0	500	mA

Electrical Characteristics

(V_{DD}=V_{OUT}(Typ.)+1V, V_{CE}=V_{DD}, Ta=25°C unless otherwise specified)

Item	Symbol	Conditions	Min.	Typ.	Max.	Unit
Input current(OFF)	I _{DDoff}	V _{CE} =0V	-	0.1	1.0	μA
No-Load Input Current	I _{DD}	I _{OUT} =0mA	-	60	80	μA
Output voltage	V _{OUT}	1.5V ≤ V _{OUT} I _{OUT} =1mA	×0.99	-	×1.01	V
		V _{OUT} < 1.5V I _{OUT} =1mA	-20	-	20	mV
Line regulation	V _{LINE}	V _{OUT} (Typ.)+0.5V ≤ V _{DD} ≤ 6.5V I _{OUT} =10mA, 2.0V ≤ V _{OUT}	-	0.05	0.2	%/V
		2.5V ≤ V _{DD} ≤ 6.5V I _{OUT} =10mA, V _{OUT} < 2.0V	-	0.05	0.2	%/V
Load regulation	V _{LOAD}	1mA ≤ I _{OUT} ≤ 500mA	-	20	60	mV
Dropout voltage	V _{io}	別紙参照	-	-	-	V
Ripple rejection *Note2	RR	f=1kHz, V _{ripple} =0.5V, I _{OUT} =10mA V _{DD} =2.5V, V _{OUT} <1.3V	-	70	-	dB
		f=1kHz, V _{ripple} =0.5V, I _{OUT} =10mA 1.3V ≤ V _{OUT} < 3.4V	-	65	-	dB
		f=1kHz, V _{ripple} =0.5V, I _{OUT} =10mA 3.4V ≤ V _{OUT} ≤ 5.0V	-	60	-	dB

*Note2:この項目は、設計保証です。





Electrical Characteristics

($V_{DD}=V_{OUT(Typ.)}+1V$, $V_{CE}=V_{DD}$, $T_a=25^{\circ}C$ unless otherwise specified)

Item	Symbol	Conditions	Min.	Typ.	Max.	Unit
Vout temperature coefficient *Note2	$\Delta V_{OUT} / \Delta T$	$I_{OUT}=100mA$ $-40 \leq T_{op} \leq 85^{\circ}C$	-	100	-	ppm/ $^{\circ}C$
Output short-circuit current *Note2	I_{short}	$V_{OUT}=0V$	-	150	-	mA
Thermal shutdown detect temperature *Note2	T_{SD}		130	150	170	$^{\circ}C$
Thermal shutdown release temperature *Note2	T_{SR}		110	130	150	$^{\circ}C$
Output Rise Time *Note2	tr	$V_{OUT} \leq 1.5V$, $C_S=0.01\mu F$	1.15	2.0	2.45	ms
		$V_{OUT} > 1.5V$, $C_S=0.01\mu F$	0.95	1.5	2.25	
CE High threshold voltage	V_{CEH}		1.2	-	6.5	V
CE Low threshold voltage	V_{CEL}		-	-	0.3	V
CE pin current	I_{CE}	$V_{CE}=2.0V$	-	0.1	-	μA
Output NMOS ON resistance *Note2	R_{DON}	$V_{CE}=0V, V_{DD}=4V$	-	15	-	Ω

*Note2: The parameter is guaranteed by design.





Electrical Characteristics

($V_{DD}=V_{OUT(Typ.)}+1V$, $V_{CE}=V_{DD}$, $T_a=25^{\circ}C$ unless otherwise specified)

Model name	Item								
	Output voltage				Dropout voltage				
	V_{OUT} (V)				V_{IO} (V)				
	Conditions	Min.	Typ.	Max.	Conditions	Min.	Typ.	Max.	
MM3823A10	$I_{OUT}=10mA$	0.985	1.000	1.015	$I_{OUT}=200mA$ $V_{OUT}<2.0V$ *Note3	-	0.40	0.60	
MM3823A11		1.085	1.100	1.115		-	0.30	0.40	
MM3823A12		1.185	1.200	1.215		-	0.14	0.20	
MM3823A13		1.285	1.300	1.315		-			
MM3823A14		1.385	1.400	1.415		-			
MM3823A15		1.485	1.500	1.515		-			
MM3823A16		1.584	1.600	1.616		-			
MM3823A17		1.683	1.700	1.717		-			
MM3823A18		1.782	1.800	1.818		-			
MM3823A19		1.881	1.900	1.919		-			
MM3823A20		1.980	2.000	2.020		$I_{OUT}=200mA$ $2.0V \leq V_{OUT}$ $V_{DD}=V_{OUT(Typ.)}-0.2V$	-	0.14	0.20
MM3823A21		2.079	2.100	2.121			-		
MM3823A22		2.178	2.200	2.222			-		
MM3823A23		2.277	2.300	2.323			-		
MM3823A24		2.376	2.400	2.424			-		
MM3823A25		2.475	2.500	2.525			-		
MM3823A26		2.574	2.600	2.626			-		
MM3823A27		2.673	2.700	2.727			-		
MM3823A28		2.772	2.800	2.828			-		
MM3823A29	2.871	2.900	2.929	-					
MM3823A30	2.970	3.000	3.030	-					
MM3823A31	3.069	3.100	3.131	-					
MM3823A32	3.168	3.200	3.232	-					
MM3823A33	3.267	3.300	3.333	-					
MM3823A34	3.366	3.400	3.434	-					
MM3823A35	3.465	3.500	3.535	-					
MM3823A36	3.564	3.600	3.636	-					
MM3823A37	3.663	3.700	3.737	-					
MM3823A38	3.762	3.800	3.838	-	0.10		0.14		
MM3823A39	3.861	3.900	3.939	-					
MM3823A40	3.960	4.000	4.040	-					
MM3823A41	4.059	4.100	4.141	-					
MM3823A42	4.158	4.200	4.242	-					
MM3823A43	4.257	4.300	4.343	-					
MM3823A44	4.356	4.400	4.444	-					
MM3823A45	4.455	4.500	4.545	-					
MM3823A46	4.554	4.600	4.646	-					
MM3823A47	4.653	4.700	4.747	-					
MM3823A48	4.752	4.800	4.848	-					
MM3823A49	4.851	4.900	4.949	-					
MM3823A50	4.950	5.000	5.050	-					

*Note3: Dropout voltage maximum value in the input and it is confirmed that there is no output abnormal voltage impression the 200mA in the model less than $V_{OUT}<2.0V$.





Electrical Characteristics

($V_{DD}=V_{OUT(Typ.)}+1V$, $V_{CE}=V_{DD}$, $T_a=25^{\circ}C$ unless otherwise specified)

Model name	Item										
	Output voltage				Dropout voltage						
	V_{OUT} (V)				V_{IO} (V)						
	Conditions	Min.	Typ.	Max.	Conditions	Min.	Typ.	Max.			
MM3823A10	$I_{OUT}=10mA$	0.985	1.000	1.015	$I_{OUT}=500mA$ $V_{OUT}<2.0V$ *Note4	-	0.40	0.60			
MM3823A11											
MM3823A12											
MM3823A13											
MM3823A14											
MM3823A15											
MM3823A16											
MM3823A17											
MM3823A18											
MM3823A19											
MM3823A20											
MM3823A21											
MM3823A22											
MM3823A23											
MM3823A24											
MM3823A25											
MM3823A26											
MM3823A27											
MM3823A28											
MM3823A29	$I_{OUT}=500mA$ $2.0V \leq V_{OUT}$ $V_{DD}=V_{OUT(Typ.)}-0.2V$	2.871	2.900	2.929	-	0.35	0.45				
MM3823A30											
MM3823A31											
MM3823A32											
MM3823A33											
MM3823A34											
MM3823A35											
MM3823A36											
MM3823A37											
MM3823A38											
MM3823A39											
MM3823A40											
MM3823A41											
MM3823A42											
MM3823A43											
MM3823A44											
MM3823A45											
MM3823A46											
MM3823A47											
MM3823A48											
MM3823A49											
MM3823A50											
MM3823A49		$I_{OUT}=500mA$ $2.0V \leq V_{OUT}$ $V_{DD}=V_{OUT(Typ.)}-0.2V$	4.851	4.900				4.949	-	0.25	0.35
MM3823A50											
MM3823A49											
MM3823A48											
MM3823A47											
MM3823A46											
MM3823A45											
MM3823A44											
MM3823A43											
MM3823A42											
MM3823A41											
MM3823A40											
MM3823A39											
MM3823A38											
MM3823A37											
MM3823A36											
MM3823A35											
MM3823A34											
MM3823A33											
MM3823A32											
MM3823A31											
MM3823A30											
MM3823A29											
MM3823A28											
MM3823A27											
MM3823A26											
MM3823A25											
MM3823A24											
MM3823A23											
MM3823A22											
MM3823A21											
MM3823A20											
MM3823A19											
MM3823A18											
MM3823A17											
MM3823A16											
MM3823A15											
MM3823A14											
MM3823A13											
MM3823A12											
MM3823A11											
MM3823A10											

*Note4: Dropout voltage maximum value in the input and it is confirmed that there is no output abnormal voltage impression the 500mA in the model less than $V_{OUT}<2.0V$.





Test Circuit

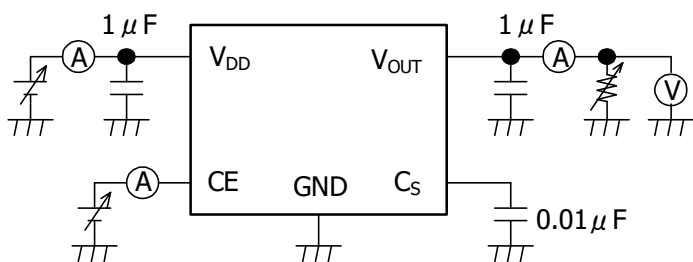

Application Circuit

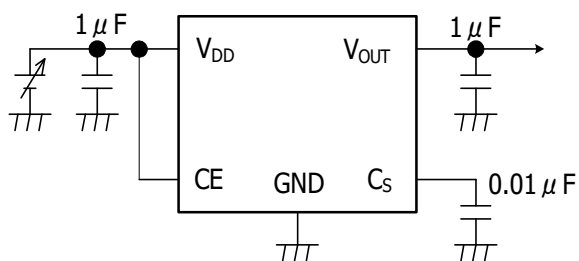

(Example of external parts)

- Output capacitor Ceramic capacitor 1.0μF
- Input capacitor Ceramic capacitor 1.0μF
- Soft start capacitor Ceramic capacitor 0.01μF *Temperature characteristics : B

- In the event a problem which may affect industrial property or any other rights of us or a third party is encountered during the use of information described in these circuit, we shall not be liable for any such problem, nor grant a license therefore.





Note

1. There is a possibility with deterioration and destruction of IC when using it exceeding the absolute maximum rating. The absolute maximum rating, never exceed it. The functional operation is not assured.
2. There is a possibility that it becomes impossible to maintain this performance and reliability IC original when using it exceeding recommended operation voltage. Please use it in recommended operation voltage.
3. Due to restrictions on the package power dissipation, the output current value may not be satisfied. Attention should be paid to the power dissipation of the package when the output current is large or the voltage between Input and Output is high.
4. The output capacitor is required between output and GND to prevent oscillation.
5. The ESR of capacitor must be defined in ESR stability area. It is possible to use a ceramic capacitor without ESR resistance for output. The ceramic capacitor must be used more than 1.0 μ F and B temperature characteristics.
6. The wire of VDD and GND is required to print full ground plane for noise and stability.
7. The input capacitor must be connected a distance of less than 1cm from input pin.
8. In case the output voltage is above the input voltage, the overcurrent flow by internal parasitic diode from output to input. In such application, the external bypass diode must be connected between output and input pin.

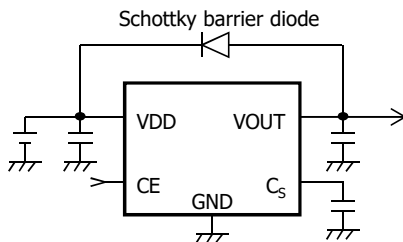

9. Please connect the soft-start capacitor(Cs) more than 0.001 μ F with the terminal Cs.
10. The output capacitor and the soft start capacitor must be connected it within the limits a rush current peak level 500mA showed in the typical performance characteristics.
11. When rush current exceeds current limit characteristics, it is restricted with the current limit set up with the chip, an output rise time is uncontrollable by soft-start capacitor.
12. When use connecting VDD and CE, in the case of starting VDD in input rise time longer then the set-up soft-start time, an output rise time is decide by a VDD input rise time.
13. Please do not give the voltage to the terminal Cs.
14. When the voltage of the soft-start pin is higher than the voltage of VDD, it becomes test mode. In that case, there is a possibility that the output voltage becomes unstable.





Note

15. It is able to an unstable operation when you use the capacitor with intense capacitance change
 The capacitor has the dependency at the power-supply voltage and the temperature.
 The capacity value changes by the environment used. Please evaluate IC in the set.
16. The overcurrent protection circuit of foldback current limit type is built into this IC.
17. There is a possibility that IC generates heat when the output terminal is short-circuited.
 However, the thermal shutdown circuit operates, and it will do operation that protects IC.
 The thermal shutdown circuit is designed only to shut the IC off to prevent thermal runaway.
 Do not continue to use the IC in an environment where the operation of this circuit is assumed.
 The characteristic changes depending on the substrate condition.
 Please evaluate IC in the set.
18. It returns automatically in temperature returned after it shuts down by self-generation of heat.
 After it returns, it shuts down again by self-generation of heat.
 It is necessary to change the environment used (IC consumption, temperature)
 if it operates in upper cycle.
19. The output voltage may not start up with TSD detect mode when VDD turn on/turn off.
20. When Input rise time is longer than Vout soft start time, the output Voltage may happen
 than the setting Voltage without a soft start function working normally.

Please set to soft-start capacitor for the VDD rise time in the slash area shown in Fig. 1.
 Please choose to a capacitor in consideration of the dispersion .
 Refer to Fig. 2 for a measurement circuit.

Condition : $V_{DD} = V_{OUT}(typ.) + 1V$, $C_E = V_{DD}$, $T_a = -40^{\circ}C \sim 85^{\circ}C$

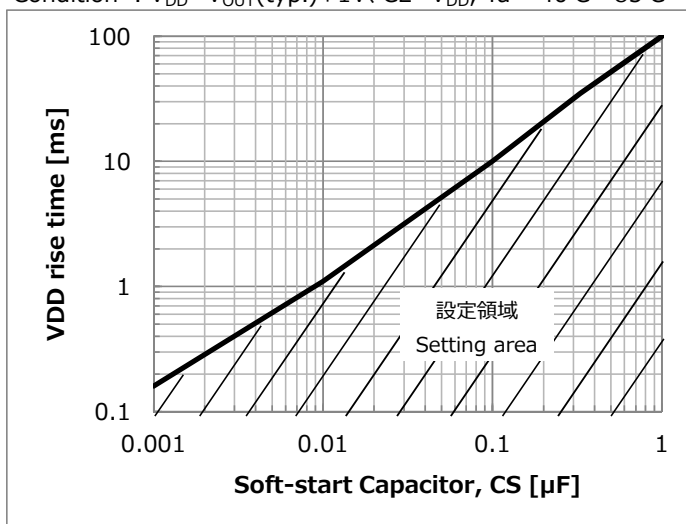

Fig, 1 Soft-start capacitor vs VDD rise time

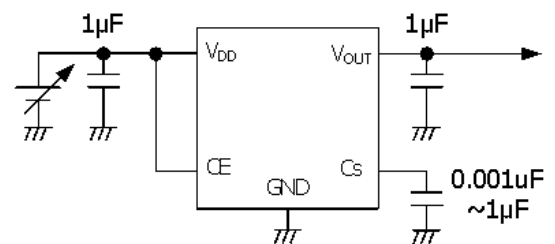

Fig, 2 Test Circuit

* VDD rise time (t) of VDD is judged in time (10%-90%) until VDD reaches Vout setting voltage.





About Power Dissipation

The Power dissipation change if board to mount IC change because radiative heat fix at board. It is reference data below, Evaluate IC in the set.

- SOT-25A

1. JEDEC51-7 standard (4 layer FR-4 board)

Board size 114.3mm×76.2mm t=1.6mm Copper foil area 80%

Power dissipation 700mW Ta=25°C

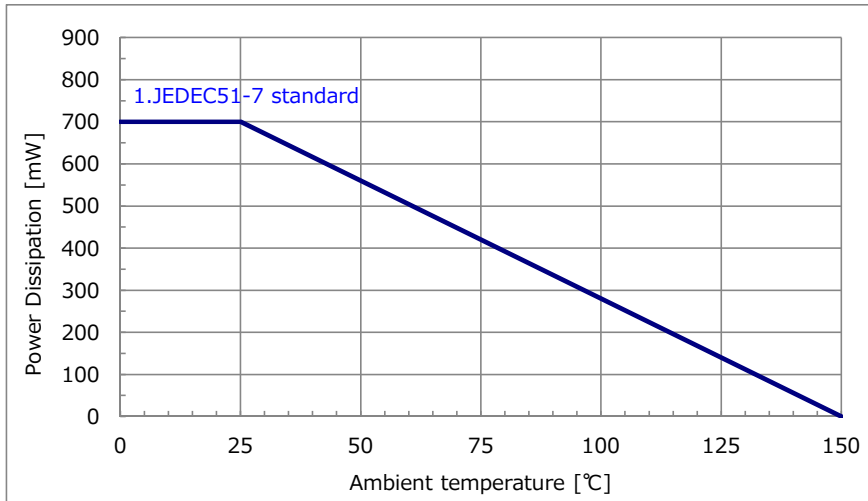

It is recommended to layout the VIA for heat radiation in the GND pattern of reverse (of IC) when there is the GND pattern in the inner layer (in using multilayer substrate). By increasing these copper foil pattern area of PCB, Power dissipation improves.





Typical Performance Characteristics (1.0V)

($V_{DD}=V_{OUT(Typ.)}+1V$, $V_{CE}=V_{DD}$, $T_a=25^\circ C$ unless otherwise specified)

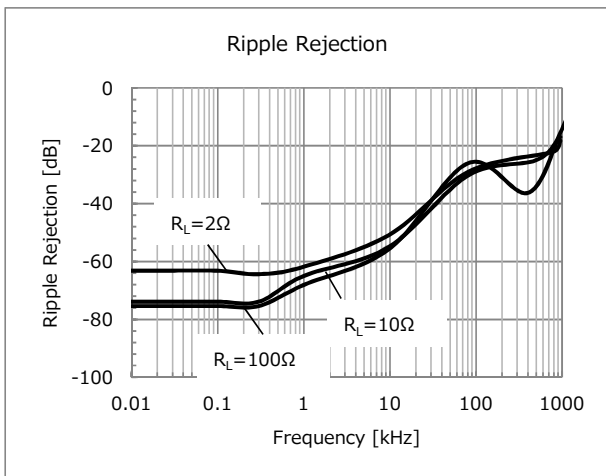
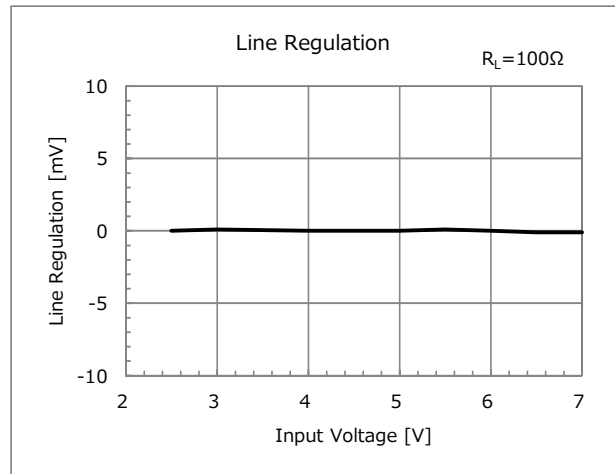
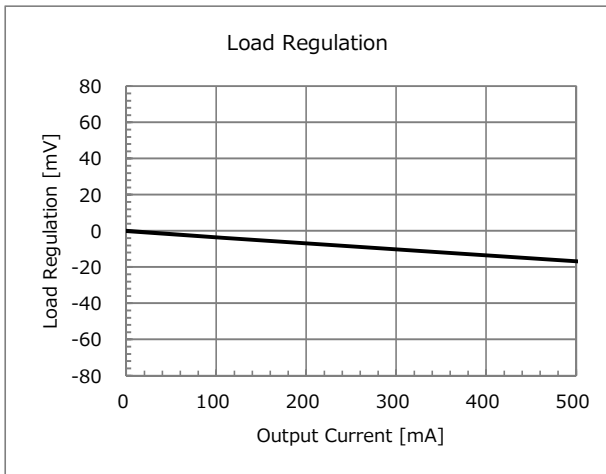
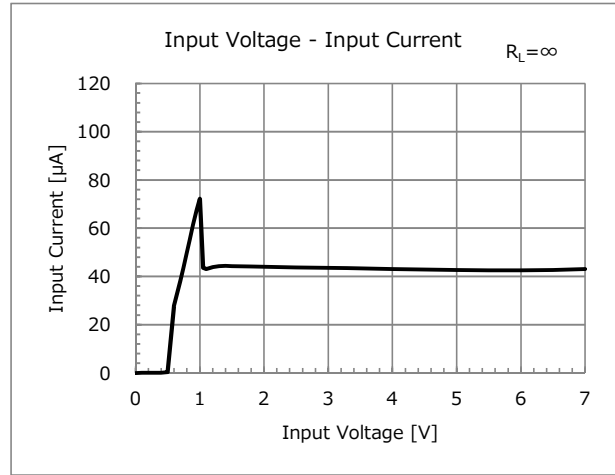
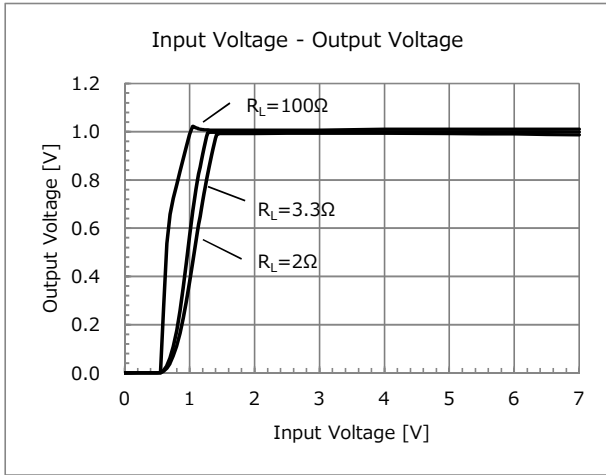



Typical Performance Characteristics (1.0V)

($V_{DD}=V_{OUT}(Typ.)+1V$, $V_{CE}=V_{DD}$, $T_a=25^\circ C$ unless otherwise specified)

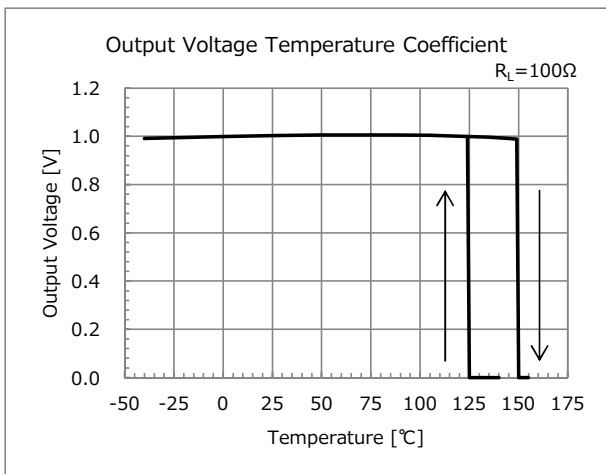
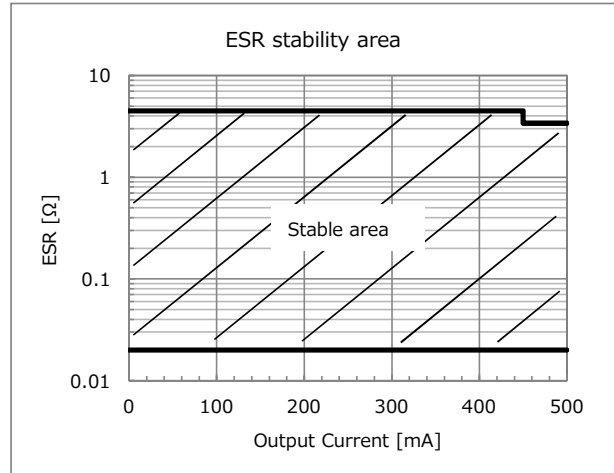
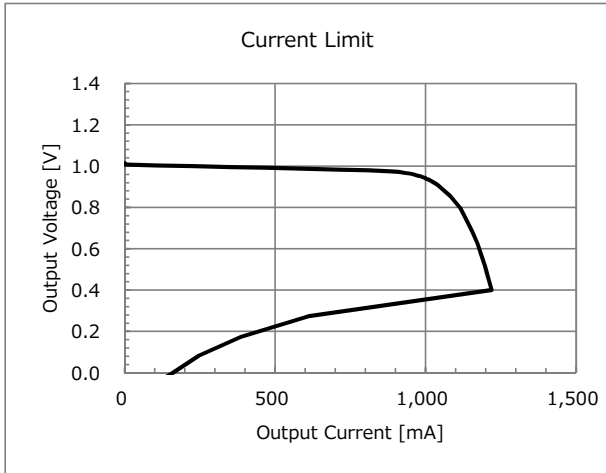

■ Load transient response

($C_{in}=C_o=1\mu F$)

$I_{OUT} : 50mA \Leftrightarrow 250mA$

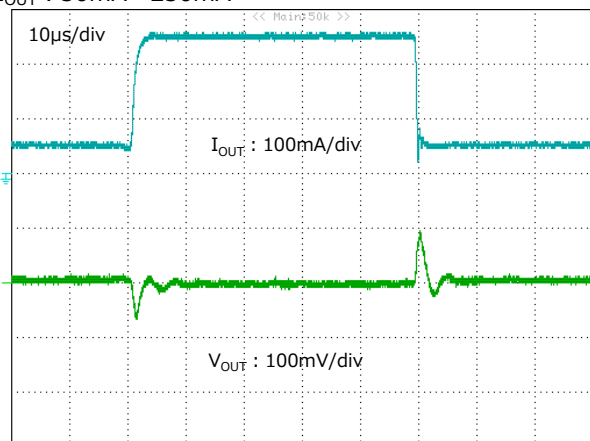

$I_{OUT} : 50mA \Leftrightarrow 500mA$

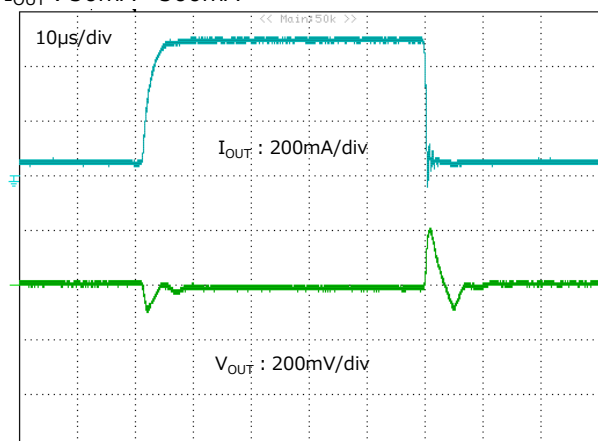



Typical Performance Characteristics (1.0V)

($V_{DD}=V_{OUT(Typ.)}+1V$, $V_{CE}=V_{DD}$, $T_a=25^\circ C$ unless otherwise specified)

CE rise characteristics1

($V_{DD}=2V$, $V_{CE}=0V \rightarrow 2V$, $C_o=1\mu F$)

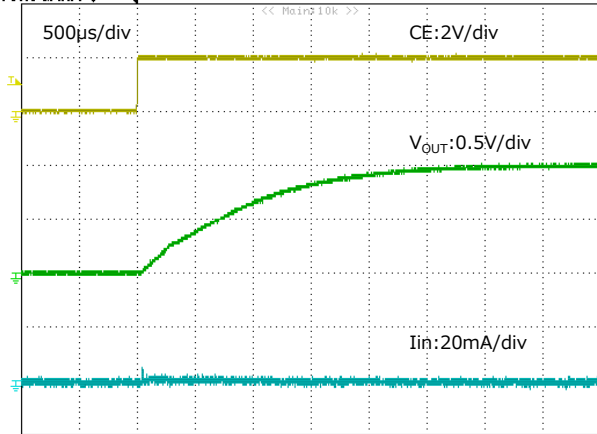

CE rise characteristics2

($V_{DD}=2V$, $V_{CE}=0V \rightarrow 2V$, $C_o=10\mu F$)

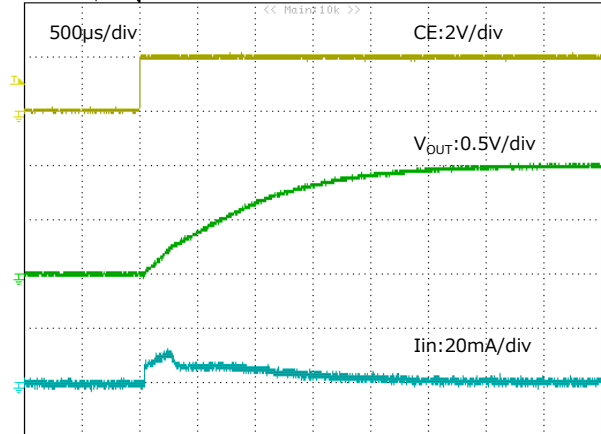

V_{OUT} discharge characteristics

($V_{DD}=2V$, $V_{CE}=2V \rightarrow 0V$, $C_o=1\mu F$)

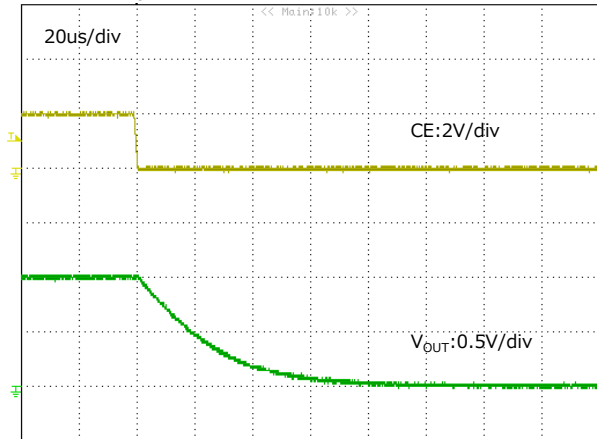

V_{CS} discharge characteristics

($V_{DD}=2V$, $V_{CE}=2V \rightarrow 0V$, $C_s=0.01\mu F$)

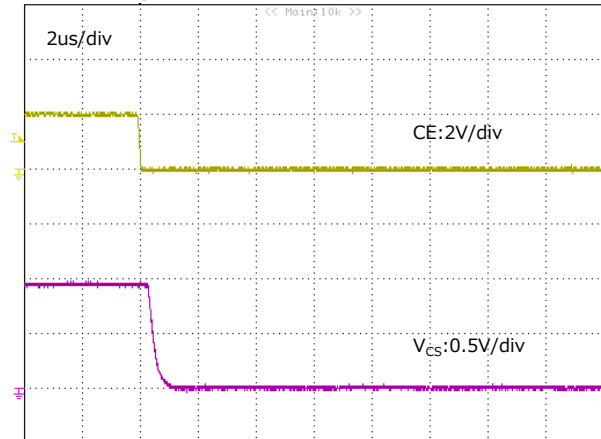

Rush Current characteristics

(C_o : aluminum electrolytic capacitor)

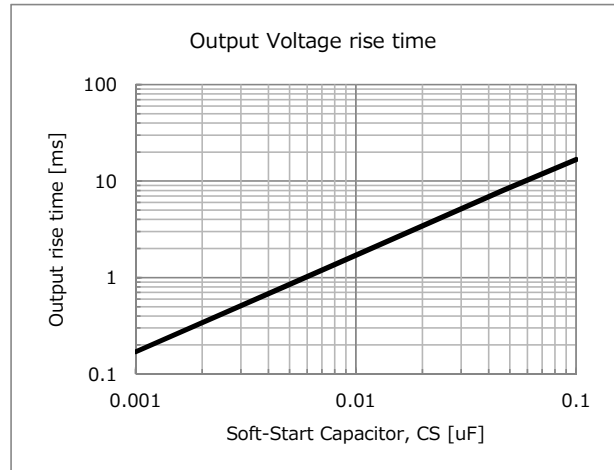
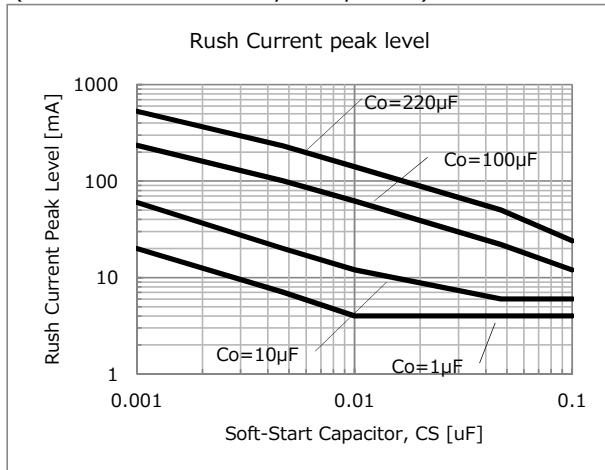



Typical Performance Characteristics (3.3V)

($V_{DD}=V_{OUT(Typ.)}+1V$, $V_{CE}=V_{DD}$, $T_a=25^\circ C$ unless otherwise specified)

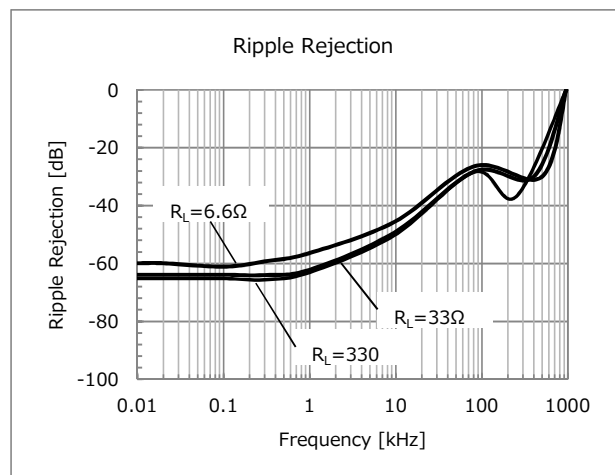
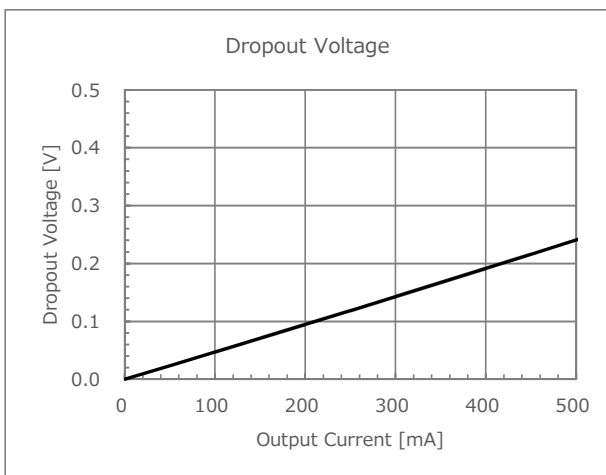
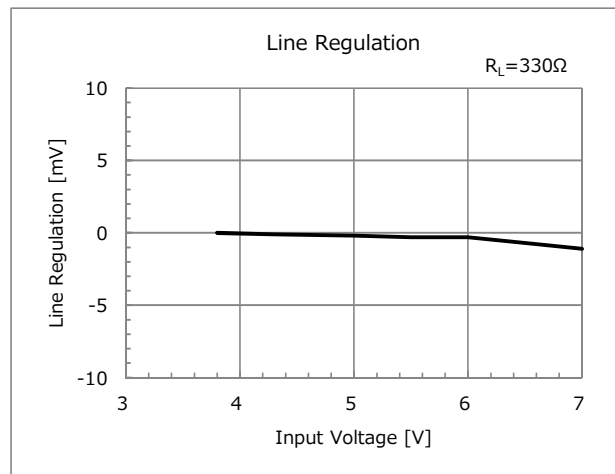
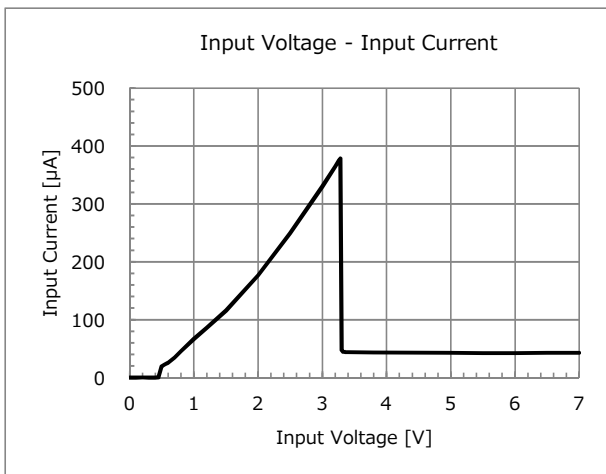
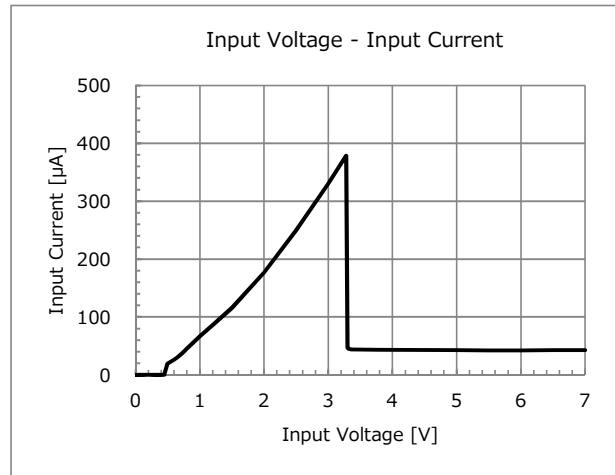
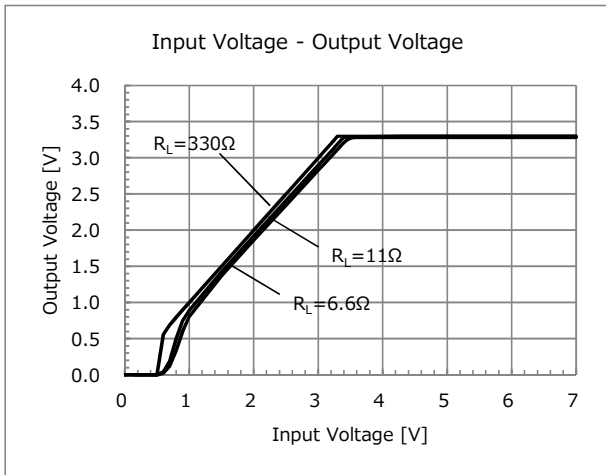



Typical Performance Characteristics (3.3V)

($V_{DD}=V_{OUT}(Typ.)+1V$, $V_{CE}=V_{DD}$, $T_a=25^\circ C$ unless otherwise specified)

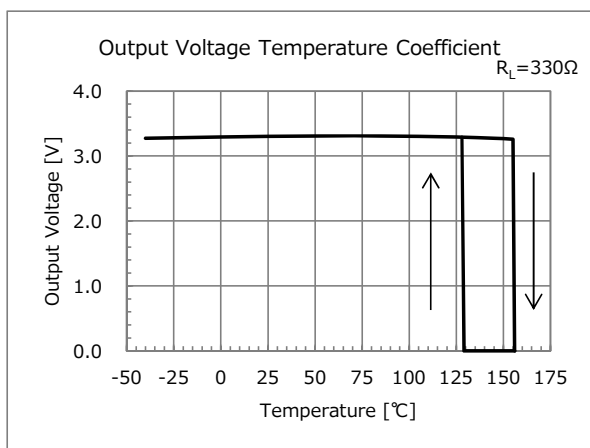
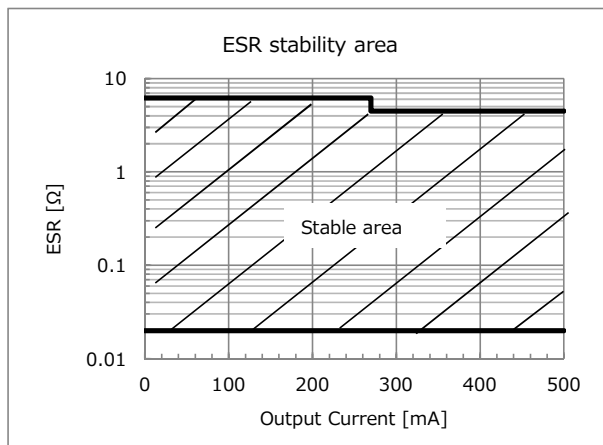
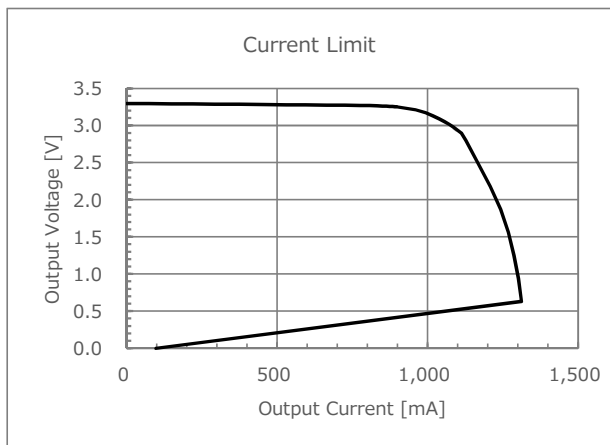

■ Load transient response

($C_{in}=C_o=1\mu F$)

$I_{OUT} : 50mA \leftrightarrow 250mA$

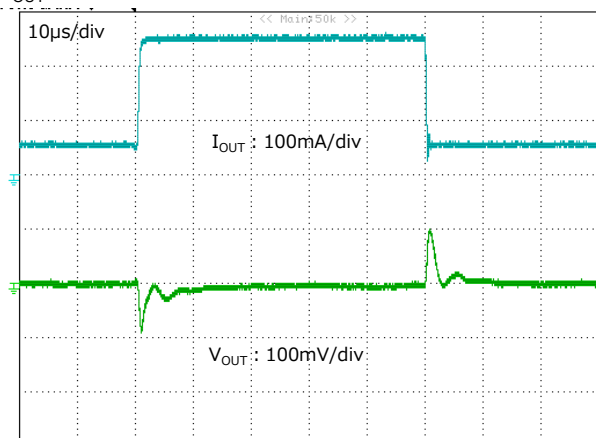

$I_{OUT} : 50mA \leftrightarrow 500mA$

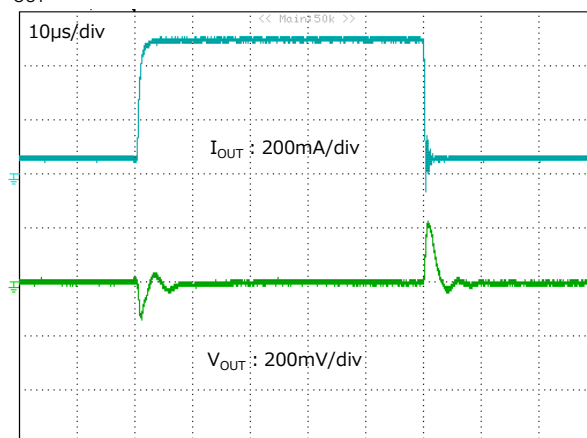



Typical Performance Characteristics (3.3V)

($V_{DD}=V_{OUT(Typ.)}+1V$, $V_{CE}=V_{DD}$, $T_a=25^\circ C$ unless otherwise specified)

CE rise characteristics1

($V_{DD}=4.3V$, $V_{CE}=0V \rightarrow 4.3V$, $C_o=1\mu F$)

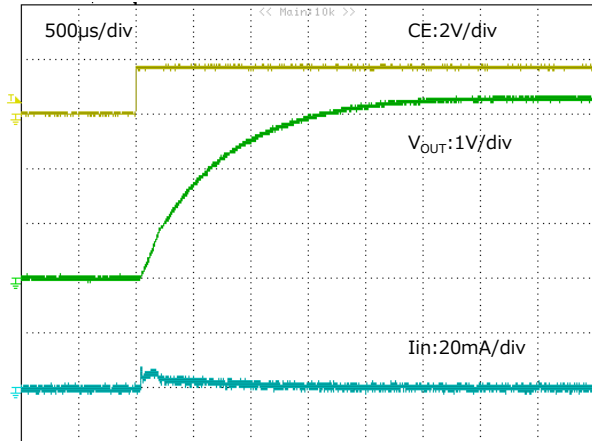

CE rise characteristics2

($V_{DD}=4.3V$, $V_{CE}=0V \rightarrow 4.3V$, $C_o=10\mu F$)

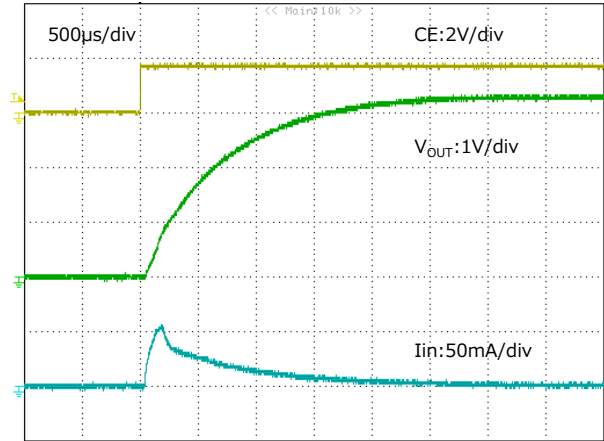

V_{OUT} discharge characteristics

($V_{DD}=4.3V$, $V_{CE}=4.3V \rightarrow 0V$, $C_o=1\mu F$)

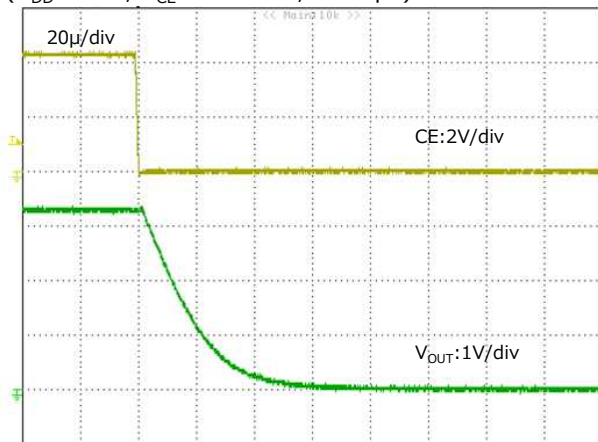

V_{CS} discharge characteristics

($V_{DD}=4.3V$, $V_{CE}=4.3V \rightarrow 0V$, $C_s=0.01\mu F$)

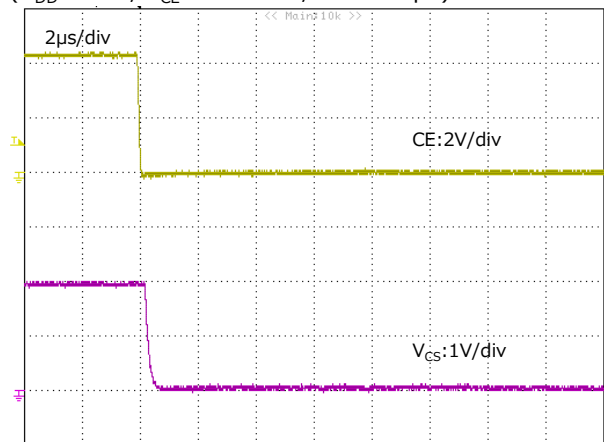

Rush Current characteristics

(C_o : aluminum electrolytic capacitor)

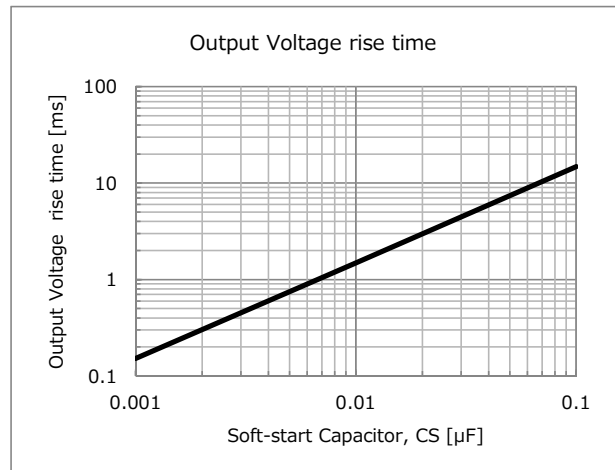
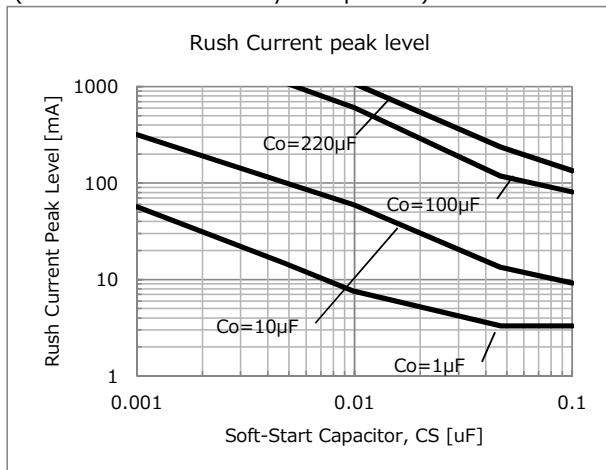



Typical Performance Characteristics (5.0V)

($V_{DD}=V_{OUT(Typ.)}+1V$, $V_{CE}=V_{DD}$, $T_a=25^\circ C$ unless otherwise specified)

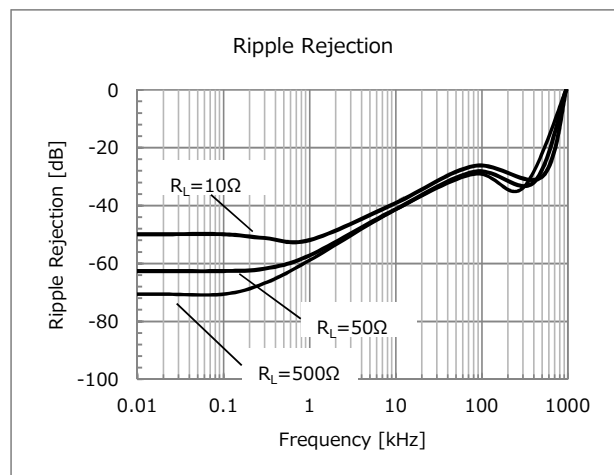
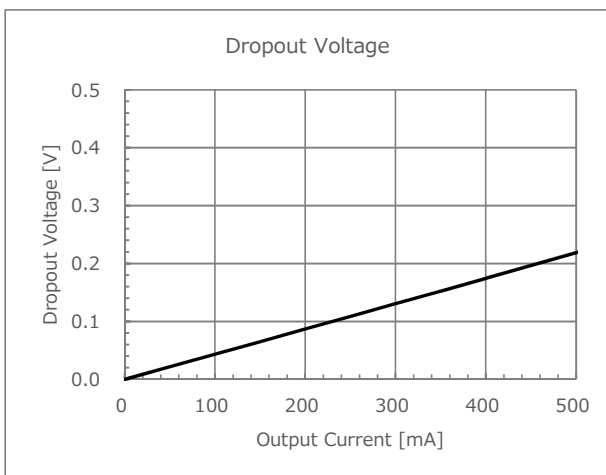
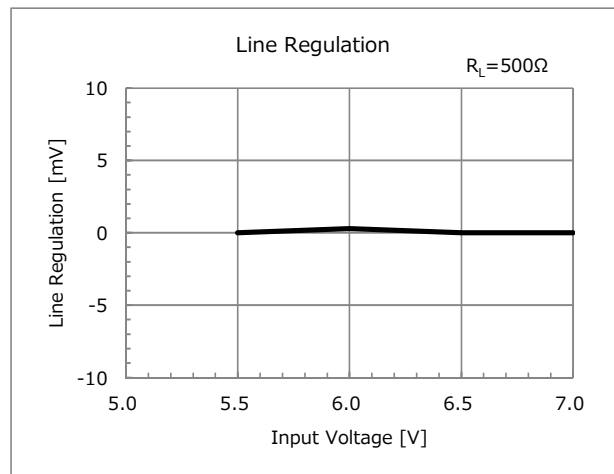
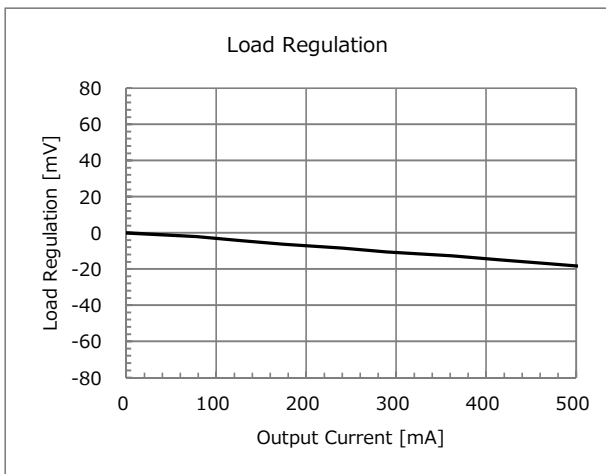
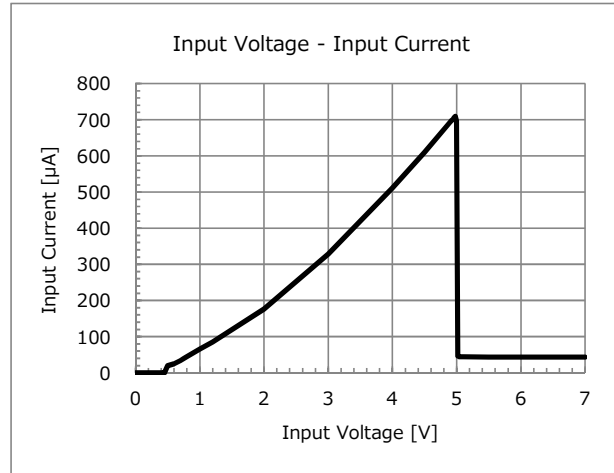
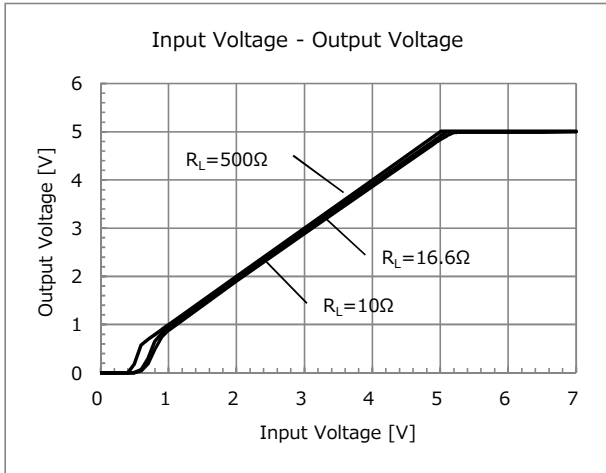



Typical Performance Characteristics (5.0V)

($V_{DD}=V_{OUT}(Typ.)+1V$, $V_{CE}=V_{DD}$, $T_a=25^\circ C$ unless otherwise specified)

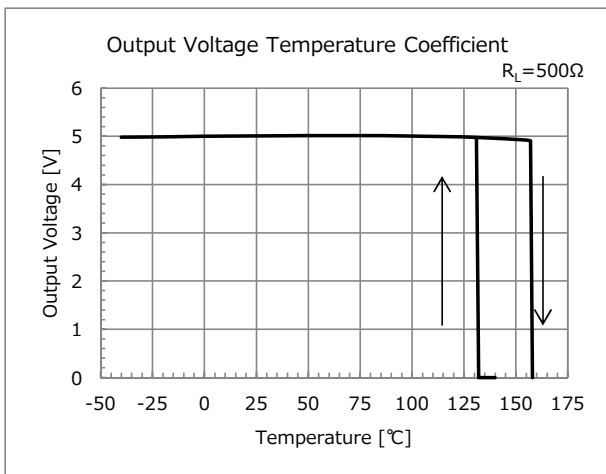
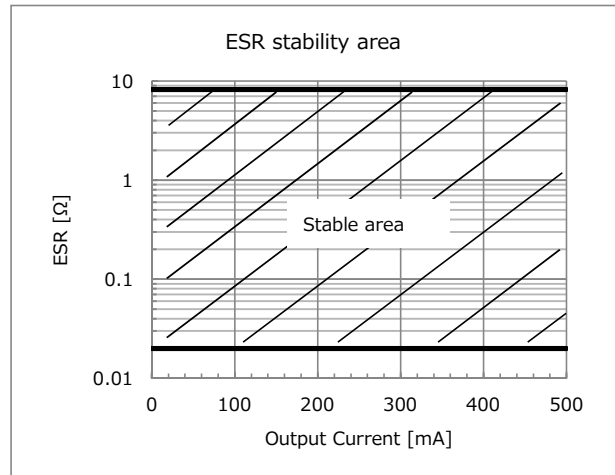
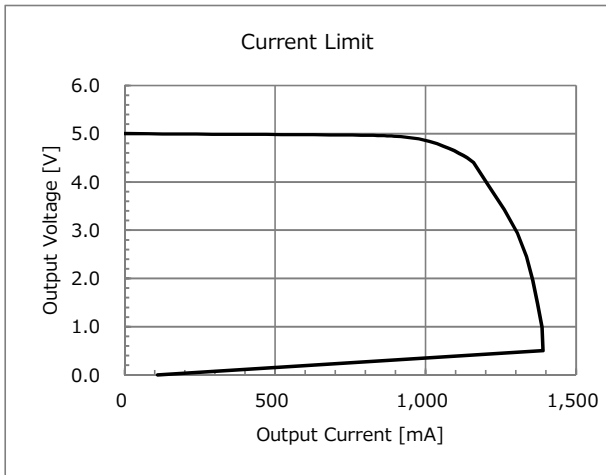

■ Load transient response

($C_{in}=C_o=1\mu F$)

$I_{OUT} : 50mA \leftrightarrow 250mA$

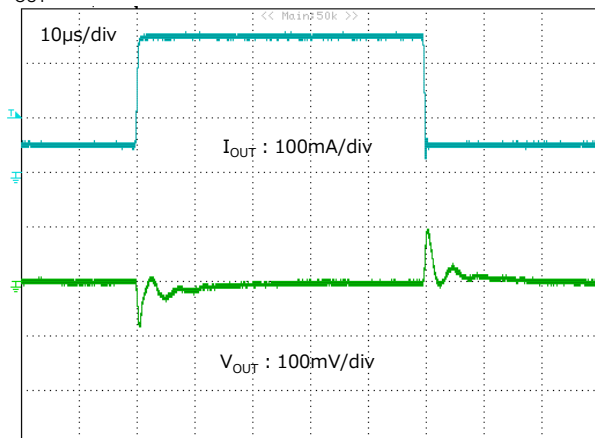

$I_{OUT} : 50mA \leftrightarrow 500mA$

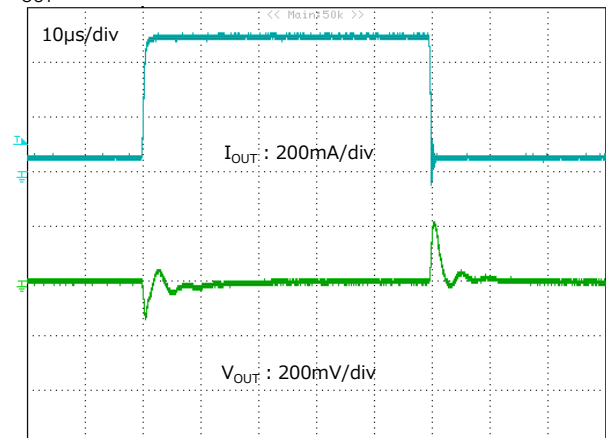



Typical Performance Characteristics (5.0V)

($V_{DD}=V_{OUT(Typ.)}+1V$, $V_{CE}=V_{DD}$, $T_a=25^\circ C$ unless otherwise specified)

CE rise characteristics1

($V_{DD}=6.0V$, $V_{CE}=0V \rightarrow 6.0V$, $C_o=1\mu F$)

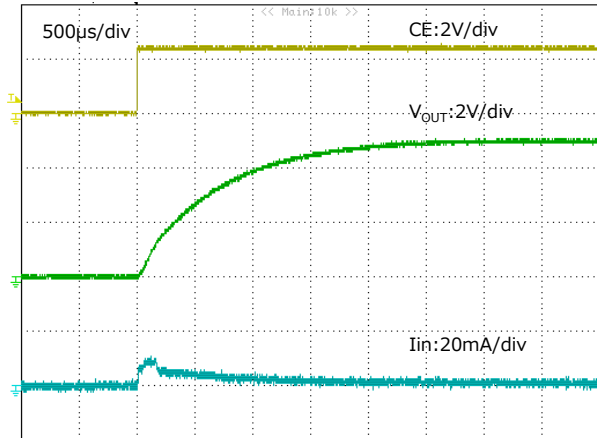

CE rise characteristics2

($V_{DD}=6.0V$, $V_{CE}=0V \rightarrow 6.0V$, $C_o=10\mu F$)

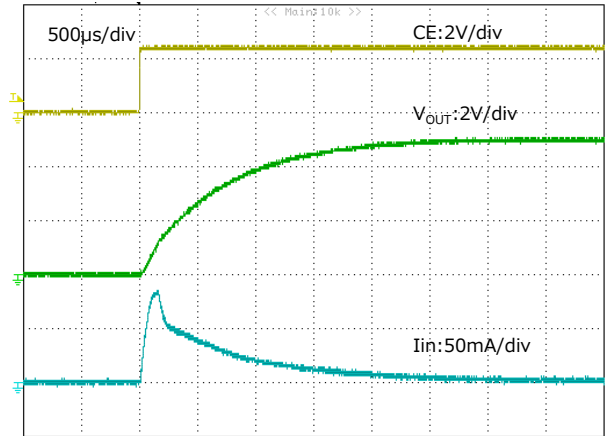

V_{OUT} discharge characteristics

($V_{DD}=6.0V$, $V_{CE}=6.0V \rightarrow 0V$, $C_o=1\mu F$)

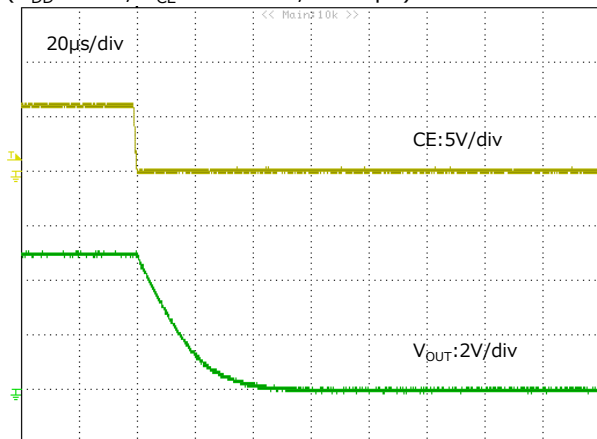

V_{CS} discharge characteristics

($V_{DD}=6.0V$, $V_{CE}=6.0V \rightarrow 0V$, $C_s=0.01\mu F$)

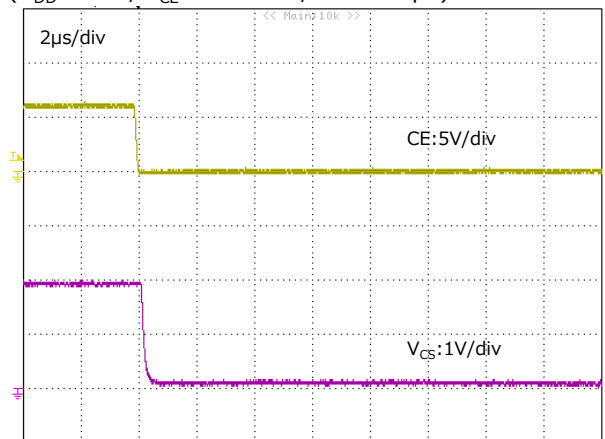

Rush Current characteristics

(C_o : aluminum electrolytic capacitor)

