



Cap less, low current consumption 200mA LDO

MM3866 Series

Overview

This IC is a Capacitor-less/Ultralow quiescent current 200mA LDO. The IC can be stable behavior without Input/Output capacitor. Therefore the number of external capacitor is reduced. The IC can be better low quiescent current and load transient by bias boost circuit. The package is a small PLP-4C (1mm x 1mm), ideal for mobile devices.

Features

- Cap less
- Low quiescent current
- Small package

Main specifications

($V_{DD}=V_{OUT}(Typ.)+1V$, $V_{CE}=V_{DD}$, $T_a=25^{\circ}C$ unless otherwise specified)

- Maximum rating supply voltage : -0.3V ~ 7V
- Operating voltage range : 1.7V ~ 6V
- Operating ambient temperature : -40°C ~ 85°C
- Output current : 200mA
- Input current (OFF) : Typ. 0.1μA
- No-load input current : Typ. 0.9μA ($V_{OUT}(Typ.) \leq 3.3V$)
Typ. 1.2μA ($3.3V < V_{OUT}(Typ.)$)
- Output voltage range : 1.2V ~ 5V (0.1V step)
- Output voltage accuracy : $\pm 1\%$ ($2.0V \leq V_{OUT}(Typ.)$)
 $\pm 20mV$ ($V_{OUT}(Typ.) < 2.0V$)
- Line regulation : Typ. 0.02%/V ($V_{DD}=V_{OUT}(Typ.)+0.5V \sim 6V$)
- Load regulation : Typ. 15mV ($I_{OUT}=1mA \sim 200mA$)
- Dropout voltage : Typ. 0.35V ($I_{OUT}=200mA$, $V_{OUT}(Typ.)=3V$)
- PSRR : Typ. 50dB ($f=1kHz$)
- Output capacitor : Unnecessary
- Protection function : Over current protection
- Additional function : ON/OFF control, Auto discharge

Packages

- PLP-4C

Application

- Portable communication device
- Photographing / Imaging device
- Wearable device
- Health care device





Pin Configuration

- PLP-4C

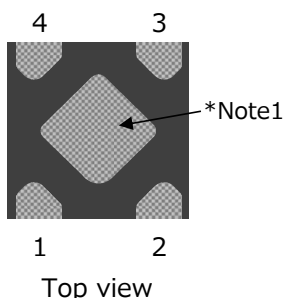

Pin No.	Pin name	Function
1	V_{OUT}	Output pin
2	GND	GND pin
3	CE	ON/OFF-control pin Connect CE pin with VDD pin, when it is not used. The CE terminal performs pull-down by constant current.
4	V_{DD}	Voltage supply pin

*Note1: Heat spreader bottom with GND.





Absolute Maximum Ratings

Item	Symbol	Min.	Max.	Unit
Storage temperature	Tstg	-55	150	°C
Junction temperature	T _{JMAX}	-	150	°C
Supply voltage	V _{DD}	-0.3	7.0	V
CE input voltage	V _{CE}	-0.3	7.0	V
Output voltage	V _{OUT}	-0.3	V _{DD} +0.3	V
Output current	I _{OUT}	-	250	mA
Power dissipation *Note2	Pd1	-	1300	mW

*Note2: JEDEC51-7 standard

Recommended Operating Conditions

Item	Symbol	Min.	Max.	Unit
Operating ambient temperature	Topr	-40	85	°C
Operating voltage	Vop	1.7	6.0	V
Output current	Iop	0	200	mA

Electrical Characteristics

(V_{DD}=V_{OUT}(Typ.)+1V, V_{CE}=V_{DD}, Ta=25°C unless otherwise specified)

Item	Symbol	Conditions	Min.	Typ.	Max.	Unit
Input current(OFF)	I _{DDOFF}	V _{CE} =0V	-	0.1	1.0	μA
No-Load Input Current	I _{DD}	1.2V ≤ V _{OUT} ≤ 3.3V I _{OUT} =0mA	-	0.9	1.5	μA
		3.4V ≤ V _{OUT} ≤ 5.0V I _{OUT} =0mA	-	1.2	2	μA
Output voltage	V _{OUT}	V _{OUT} > 2.00V I _{OUT} = 1mA	×0.99	-	×1.01	V
		V _{OUT} ≤ 2.00V I _{OUT} = 1mA	-20	-	20	mV
Line regulation	V _{LINE}	V _{OUT} (Typ.)+0.5V ≤ V _{DD} ≤ 6.0V I _{OUT} = 1mA	-	0.02	0.10	%/V
Load regulation	V _{LOAD}	1mA ≤ I _{OUT} ≤ 200mA	-	15	40	mV
Dropout voltage	V _{io}	Please refer to another page.	-	-	-	V
Ripple rejection *Note3	RR	f=1kHz, V _{ripple} =0.5V I _{OUT} =30mA	-	50	-	dB
Vout temperature coefficient *Note3	ΔV _{OUT} /ΔT	-40 ≤ Top ≤ 85°C	-	±80	-	ppm/°C

*Note3: The parameter is guaranteed by design.





Electrical Characteristics

($V_{DD}=V_{OUT(Typ.)}+1V$, $V_{CE}=V_{DD}$, $T_a=25^{\circ}C$ unless otherwise specified)

Item	Symbol	Conditions	Min.	Typ.	Max.	Unit
Output short-circuit current *Note3	I_{short}	$V_{OUT}=0V$	-	100	-	mA
CE High threshold voltage	V_{CEH}		1.5	-	V_{DD}	V
CE Low threshold voltage	V_{CEL}		0	-	0.3	V
CE pin current *Note3	I_{CEH}		-	0.3	-	μA
Output NMOS ON resistance *Note3	R_{DON}	$V_{CE}=0V, V_{DD}=4V$	-	10	-	Ω

*Note3: The parameter is guaranteed by design.





Electrical Characteristics

($V_{DD}=V_{OUT}(Typ.)+1V$, $V_{CE}=V_{DD}$, $T_a=25^{\circ}C$ unless otherwise specified)

Model name	Item							
	Output voltage				Dropout voltage			
	V_{OUT} (V)				V_{io} (V)			
	Conditions	Min.	Typ.	Max.	Conditions	Min.	Typ.	Max.
MM3866A12	$I_{OUT}=1mA$	1.184	1.200	1.216	$I_{OUT}=200mA$ $1.2V \leq V_{OUT} < 2.4V$ *Note4	-	1.01	1.40
MM3866A13		1.284	1.300	1.316		-	0.71	1.07
MM3866A14		1.384	1.400	1.416		-	0.59	0.87
MM3866A15		1.484	1.500	1.516		-	0.45	0.67
MM3866A16		1.584	1.600	1.616		-	0.42	0.57
MM3866A17		1.684	1.700	1.716		-	0.35	0.50
MM3866A18		1.784	1.800	1.816		-	0.32	0.45
MM3866A19		1.884	1.900	1.916		-		
MM3866A20		1.984	2.000	2.016		-		
MM3866A21		2.083	2.100	2.117		-		
MM3866A22		2.182	2.200	2.218		-		
MM3866A23		2.282	2.300	2.318	-			
MM3866A24		2.381	2.400	2.419	-			
MM3866A25		2.480	2.500	2.520	-			
MM3866A26		2.579	2.600	2.621	-			
MM3866A27		2.678	2.700	2.722	-			
MM3866A28		2.778	2.800	2.822	-			
MM3866A29		2.877	2.900	2.923	-			
MM3866A30		2.976	3.000	3.024	-			
MM3866A31		3.075	3.100	3.125	-			
MM3866A32		3.174	3.200	3.226	-			
MM3866A33	3.274	3.300	3.326	-				
MM3866A34	3.373	3.400	3.427	-				
MM3866A35	3.472	3.500	3.528	-				
MM3866A36	3.571	3.600	3.629	-				
MM3866A37	3.670	3.700	3.730	-				
MM3866A38	3.770	3.800	3.830	-				
MM3866A39	3.869	3.900	3.931	-				
MM3866A40	3.968	4.000	4.032	-				
MM3866A41	4.067	4.100	4.133	-				
MM3866A42	4.166	4.200	4.234	-				
MM3866A43	4.266	4.300	4.334	-				
MM3866A44	4.365	4.400	4.435	-				
MM3866A45	4.464	4.500	4.536	-				
MM3866A46	4.563	4.600	4.637	-				
MM3866A47	4.662	4.700	4.738	-				
MM3866A48	4.762	4.800	4.838	-				
MM3866A49	4.861	4.900	4.939	-				
MM3866A50	4.960	5.000	5.040	-				

*Note4:Dropout voltage MAX value in the input and it is confirmed that there is no output abnormal voltage impression the load 200mA in the model less than $V_{out} < 2.5V$.





Test Circuit

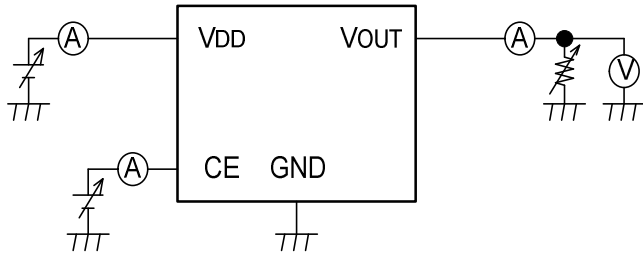

Application Circuit

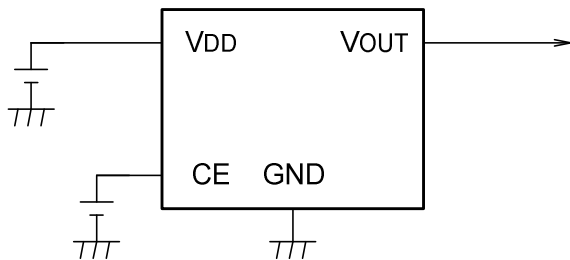

- In the event a problem which may affect industrial property or any other rights of us or a third party is encountered during the use of information described in these circuit, we shall not be liable for any such problem, nor grant a license therefore.





Note

1. Please use this IC within the stated absolute maximum ratings.
The IC is liable to malfunction should the ratings be exceeded.
2. Due to restrictions on the package power dissipation, the output current value may not be satisfied.
Attention should be paid to the power dissipation of the package when the output current is large or the voltage between Iinput and Output is high.
3. The output capacitor is required between output and GND to prevent oscillation.
4. In case the output voltage is above the input voltage, the overcurrent flow by internal parastic diode from output to input.
In such application, the external bypass diode must be connected between output and input pin.
5. This IC will limit the output current with the overcurrent protection circuit when the overcurrent and the output do short-circuit.
However, IC generates heat because of the substrate and use conditions and there is a possibility of destroying it exceeding a permissible loss.
The characteristic changes depending on the substrate condition.
Please evaluate IC in the set.
6. Please keep in mind that output voltage may rise by the leakage current of a power transistor if it is used by low load current($I_o < 10\mu A$) at the time of high temperature.
7. When the terminal VDD(CE) is OFF→ON, the overshoot might be generated.
The size of the overshoot depends on "output capacity", "output load", a "voltage rank", and "VDD standup speed." and evaluate it enough with a real machine, please.
Please refer to typical performance characteristics of the Turn-ON Transient Response.
8. There is a possibility of becoming load transient response characteristic deteriorates when using it with Dropout voltage less than about 1V. Please evaluate it enough when there is no margin in Dropout voltage.
Please refer to typical performance characteristics.
9. MM3866 is not an air discharge measures product.
10. MM3866 does not have the thermal shutdown protection.
11. The CE terminal is pulled down by an internal constant current source.
The pull-down capability is set to a small value of $0.1\mu A$ (Typ.).
Depending on the value of noise or leak current, pull-down may not be possible.
Please use the product after thoroughly evaluating it on the actual machine.
Be sure to design the CE terminal to operate with low impedance (I/O output, etc.) , while avoiding pull-down due to open circuit.





About Power Dissipation

The Power dissipation change if board to mount IC change because radiative heat fix at board. It is reference data below, Evaluate IC in the set.

- PLP-4C

1. JEDEC51-7 standard (4 layer FR-4 board)

Board size 114.3mm×76.2mm t=1.6mm Copper foil area 80%

Power dissipation 1300mW Ta=25°C

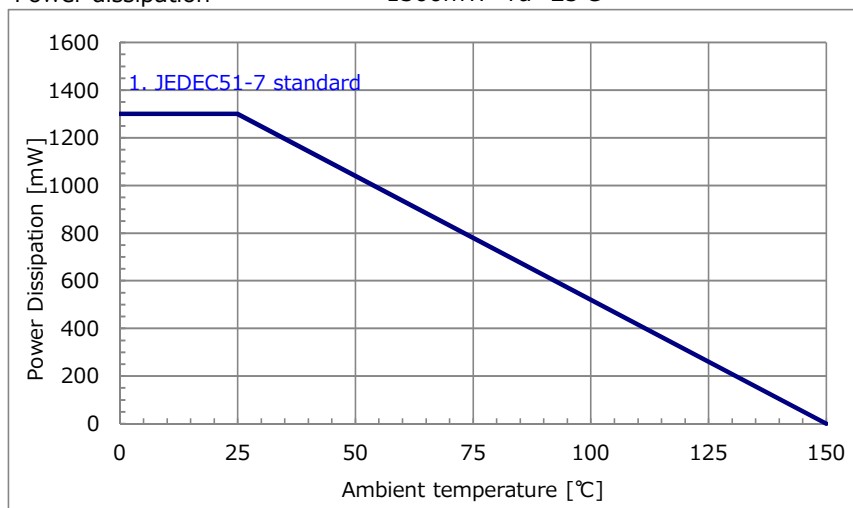

It is recommended to layout the VIA for heat radiation in the GND pattern of reverse (of IC) when there is the GND pattern in the inner layer (in using multiplayer substrate). By increasing these copper foil pattern area of PCB, Power dissipation improves.





Typical Performance Characteristics (1.2V)

($V_{DD}=V_{OUT}(Typ.)+1V$, $V_{CE}=V_{DD}$, $T_a=25^{\circ}C$ unless otherwise specified)

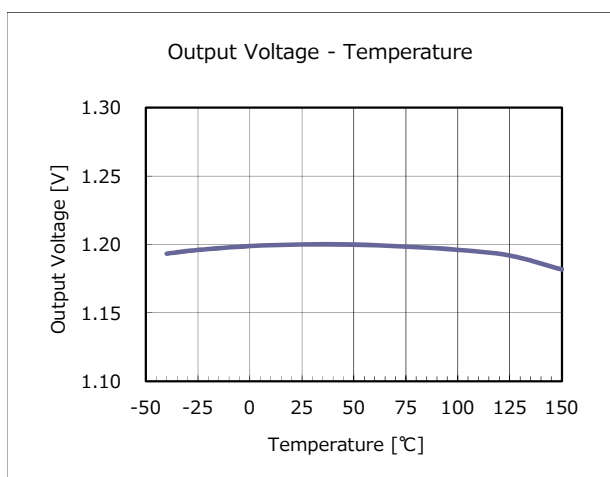
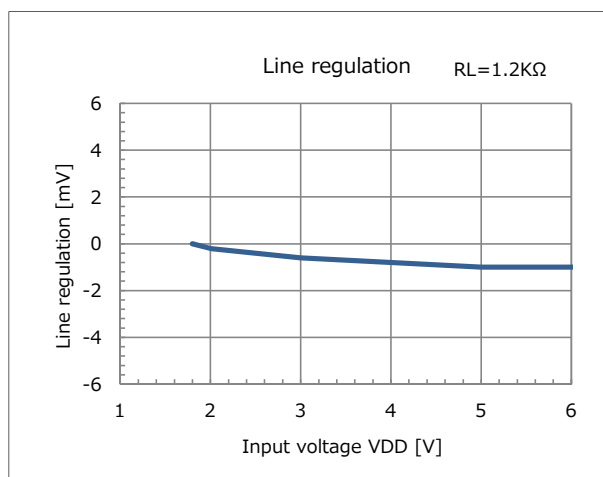
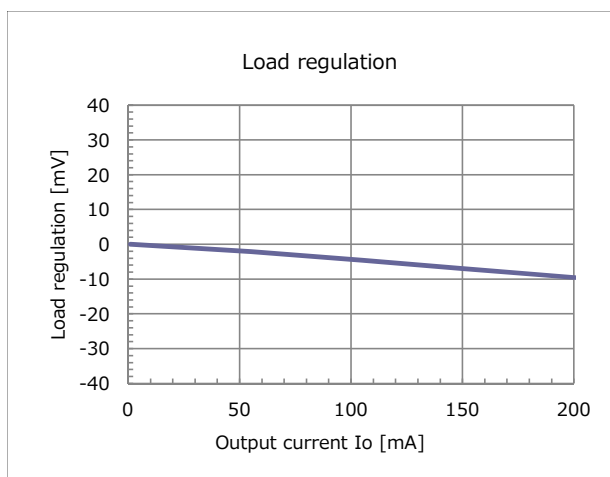
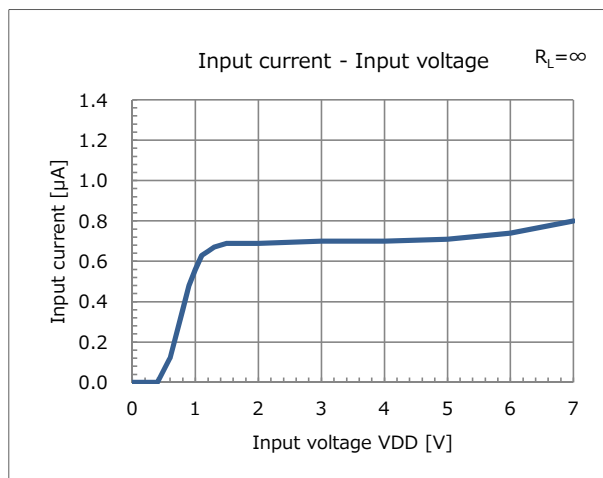
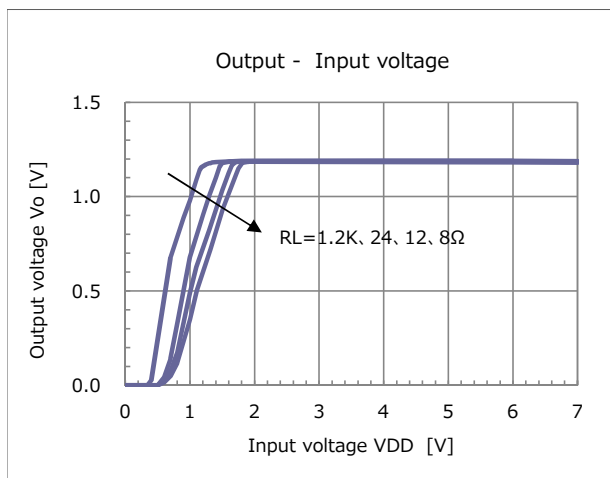



Typical Performance Characteristics (1.2V)

($V_{DD}=V_{OUT}(Typ.)+1V$, $V_{CE}=V_{DD}$, $T_a=25^{\circ}C$ unless otherwise specified)

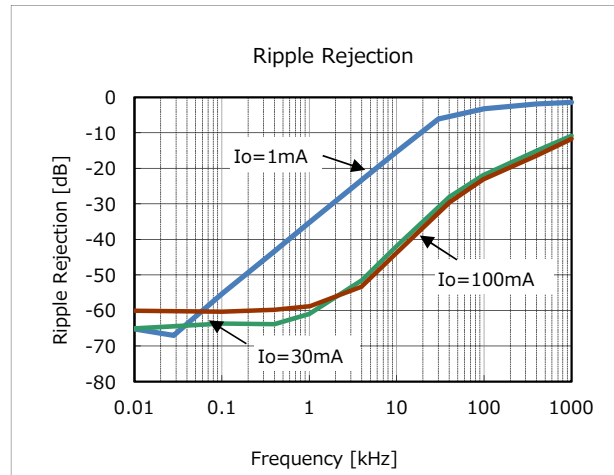
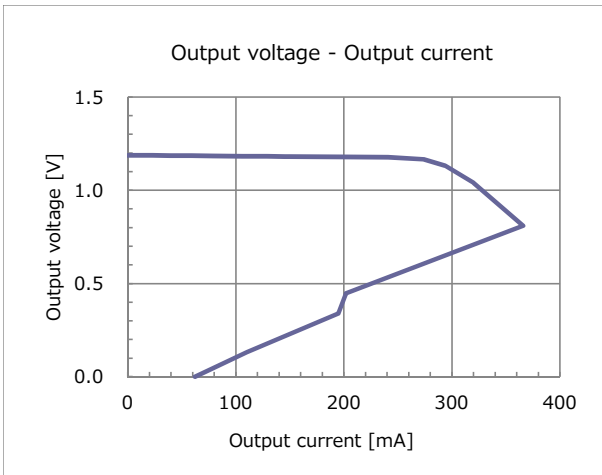



Typical Performance Characteristics (1.2V)

($V_{DD}=V_{OUT}(Typ.)+1V$, $V_{CE}=V_{DD}$, $T_a=25^{\circ}C$ unless otherwise specified)

- Load transient response

($V_{DD}=V_{OUT}+1V$, $V_{CE}=V_{DD}$)

$I_{OUT} : 50mA \leftrightarrow 100mA$, $C_{in}=C_{o}=0.1\mu F$

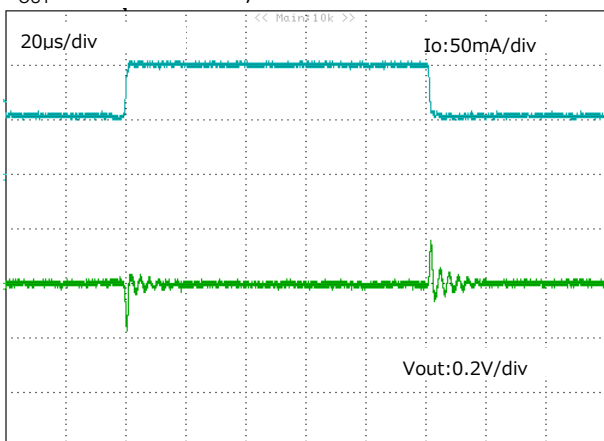

$I_{OUT} : 50mA \leftrightarrow 100mA$, $C_{in}=C_{o}=None$

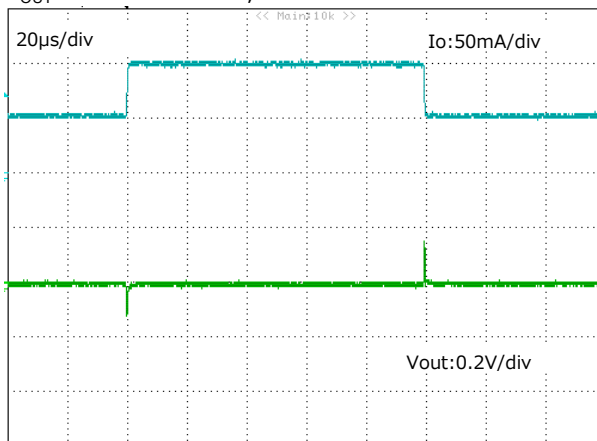

$I_{OUT} : 1mA \leftrightarrow 150mA$, $C_{in}=C_{o}=0.1\mu F$

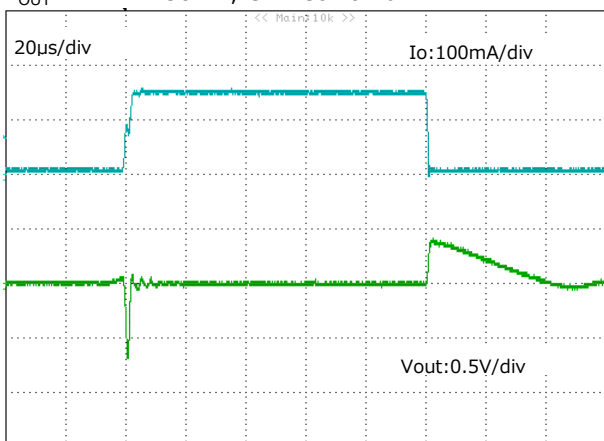

$I_{OUT} : 1mA \leftrightarrow 150mA$, $C_{in}=C_{o}=None$

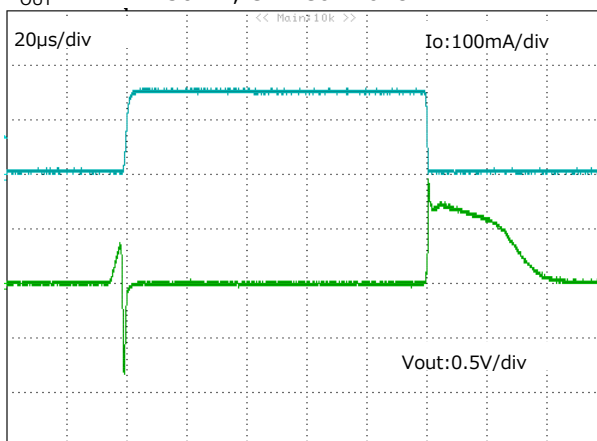

$I_{OUT} : 10mA \leftrightarrow 150mA$, $C_{in}=C_{o}=0.1\mu F$

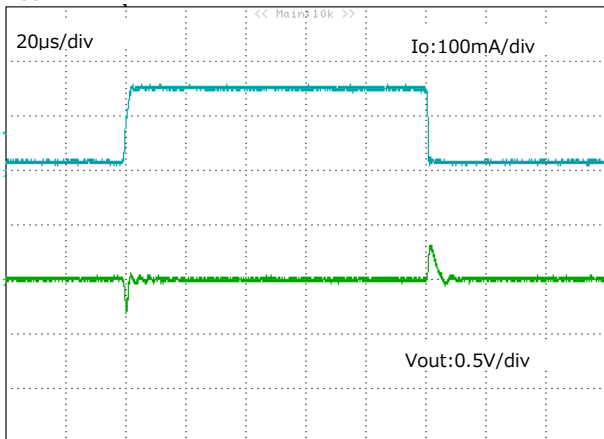

$I_{OUT} : 10mA \leftrightarrow 150mA$, $C_{in}=C_{o}=None$

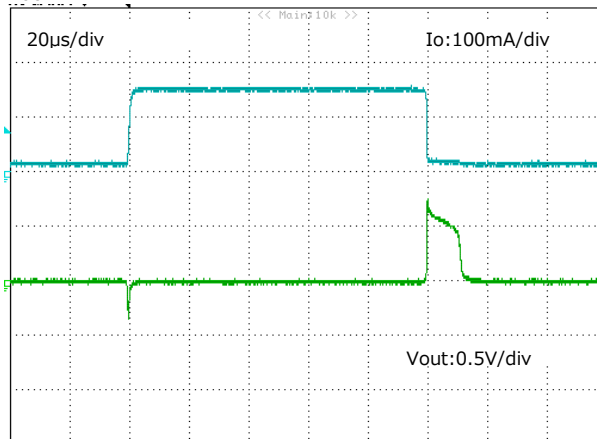



Typical Performance Characteristics (1.2V)

($V_{DD}=V_{OUT(Typ.)}+1V$, $V_{CE}=V_{DD}$, $T_a=25^{\circ}C$ unless otherwise specified)

Load transient response

($V_{DD}=V_{OUT}+1V$, $V_{CE}=V_{DD}$, $C_{in}=C_{o}=\text{none}$)

$V_{DD}=2.2V$, $I_{OUT} : 50mA \Leftrightarrow 100mA$

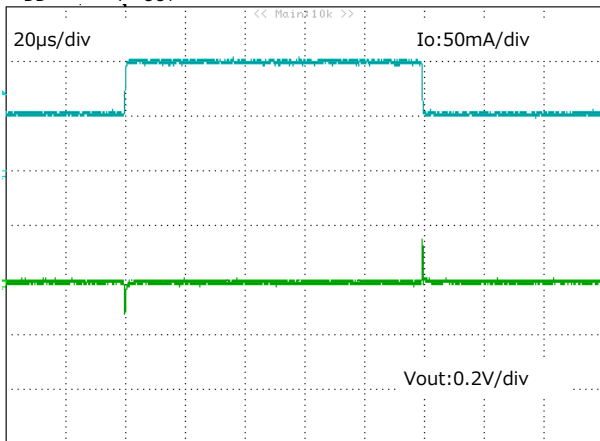

$V_{DD}=2.0V$, $I_{OUT} : 50mA \Leftrightarrow 100mA$

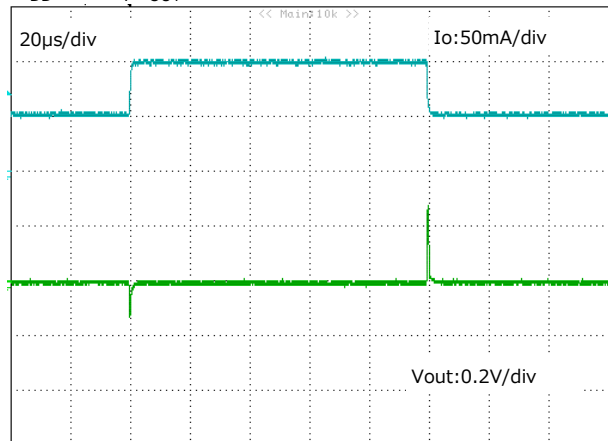

$V_{DD}=2.2V$, $I_{OUT} : 10mA \Leftrightarrow 150mA$

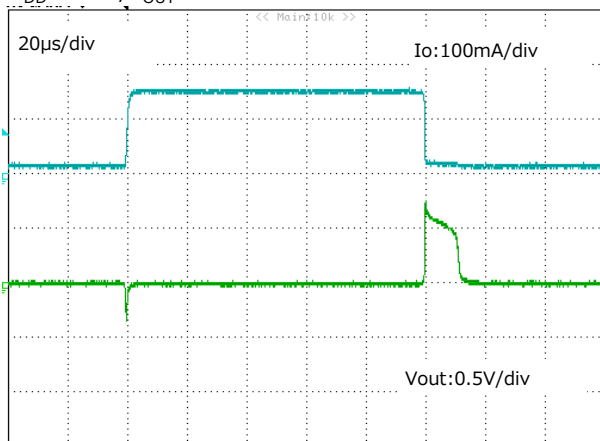

$V_{DD}=2.0V$, $I_{OUT} : 10mA \Leftrightarrow 150mA$

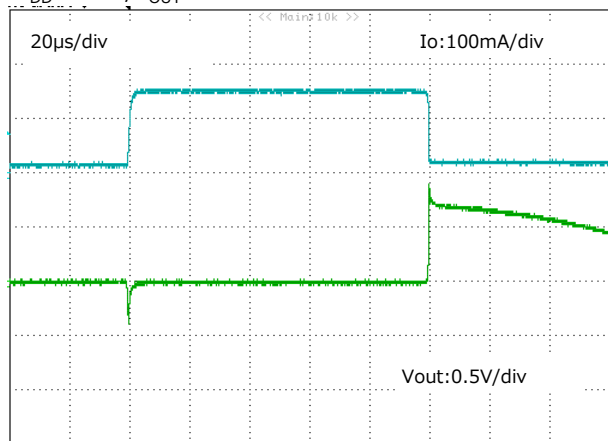

Output Rise & Rush Current

($V_{DD}=0V \rightarrow 2.2V$, $V_{CE}=V_{DD}$, $C_{in}=C_{o}=\text{None}$, $I_{OUT}=1mA$)

$t_r=1\mu s$ ($V_{DD} : 10\% \sim 90\%$)

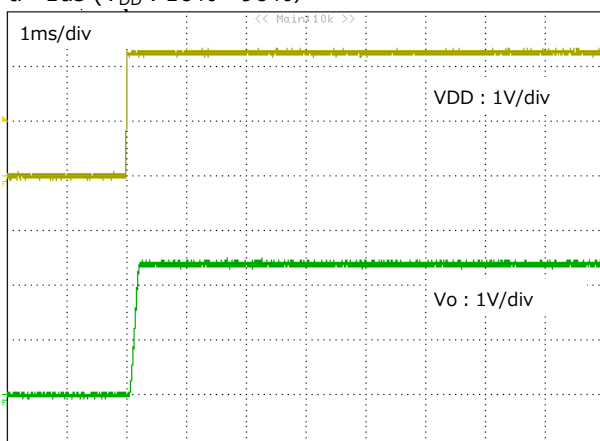

$t_r=1ms$ ($V_{DD} : 10\% \sim 90\%$)

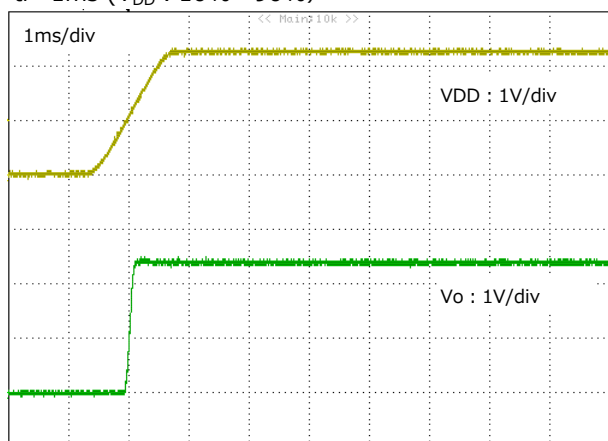



Typical Performance Characteristics (3.3V)

($V_{DD}=V_{OUT(Typ.)}+1V$, $V_{CE}=V_{DD}$, $T_a=25^\circ C$ unless otherwise specified)

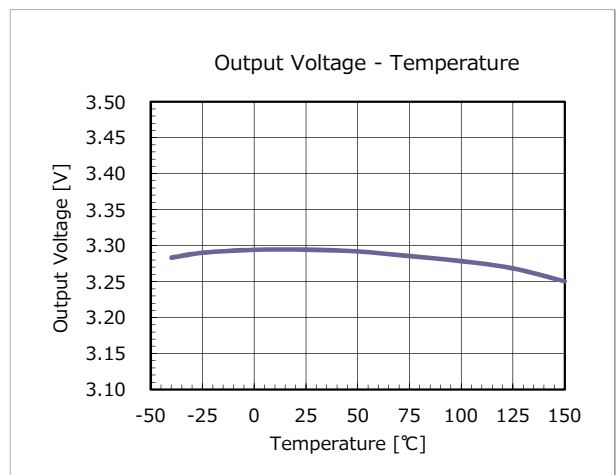
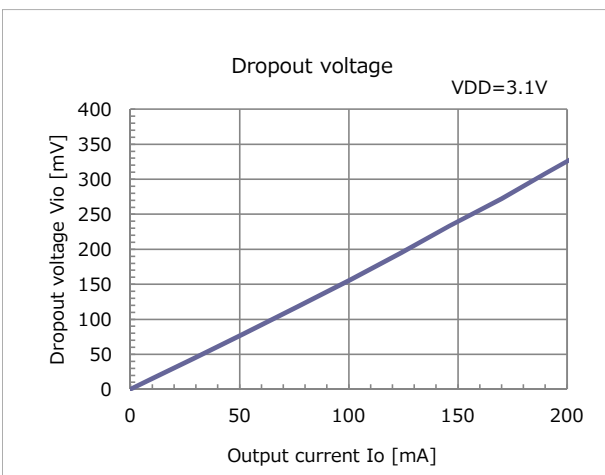
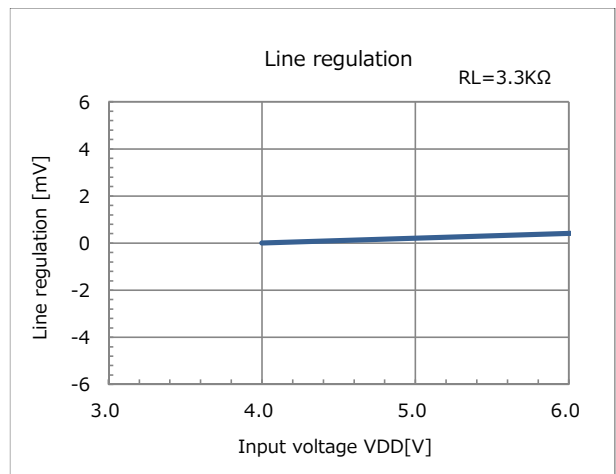
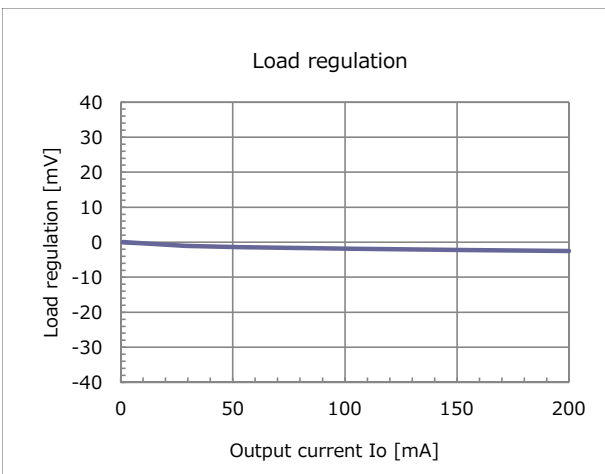
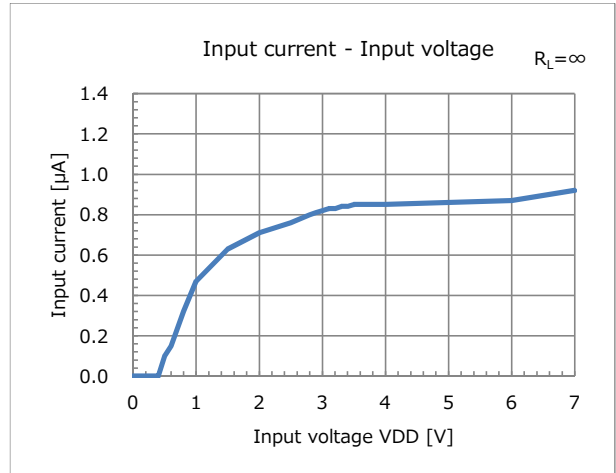
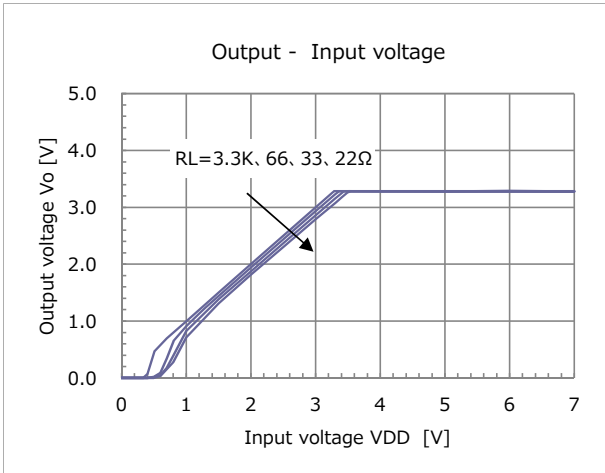



Typical Performance Characteristics (3.3V)

($V_{DD}=V_{OUT}(Typ.)+1V$, $V_{CE}=V_{DD}$, $T_a=25^{\circ}C$ unless otherwise specified)

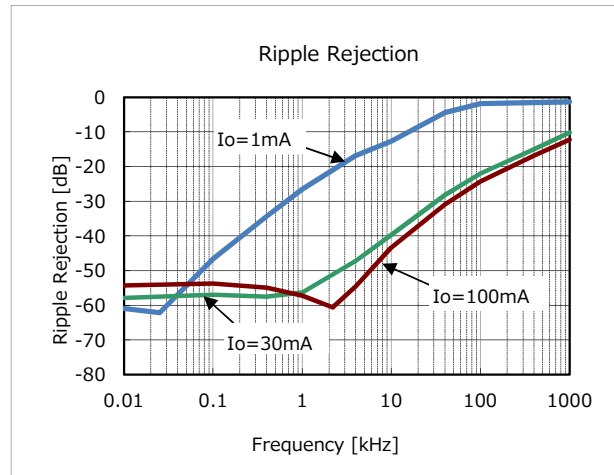
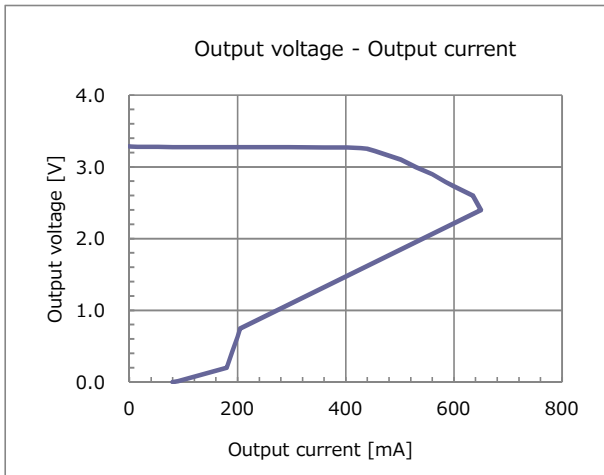



Typical Performance Characteristics (3.3V)

($V_{DD}=V_{OUT}(Typ.)+1V$, $V_{CE}=V_{DD}$, $T_a=25^{\circ}C$ unless otherwise specified)

- Load transient response

($V_{DD}=V_{OUT}+1V, V_{CE}=V_{DD}$)

$I_{OUT} : 50mA \Leftrightarrow 100mA, C_{in}=C_{o}=0.1\mu F$

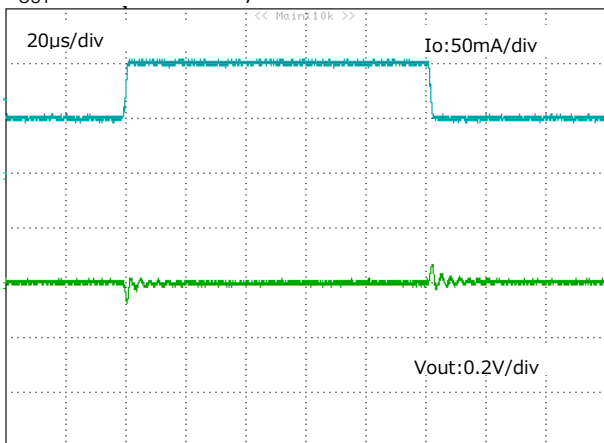

$I_{OUT} : 50mA \Leftrightarrow 100mA, C_{in}=C_{o}=None$

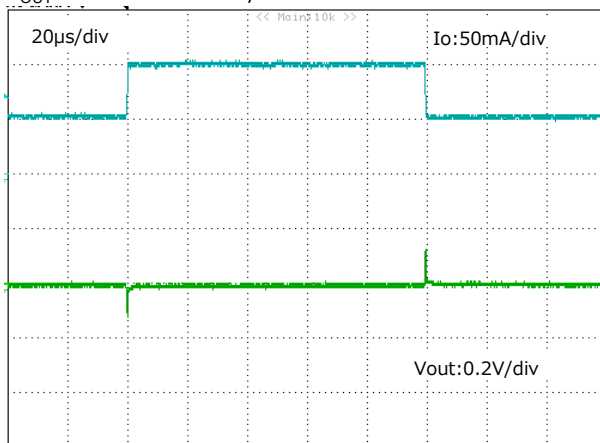

$I_{OUT} : 1mA \Leftrightarrow 150mA, C_{in}=C_{o}=0.1\mu F$

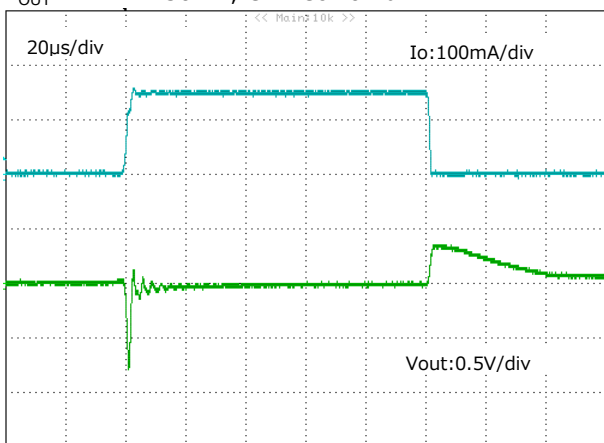

$I_{OUT} : 1mA \Leftrightarrow 150mA, C_{in}=C_{o}=None$

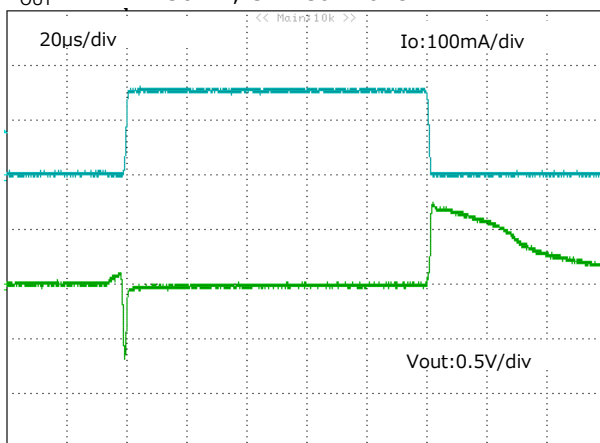

$I_{OUT} : 10mA \Leftrightarrow 150mA, C_{in}=C_{o}=0.1\mu F$

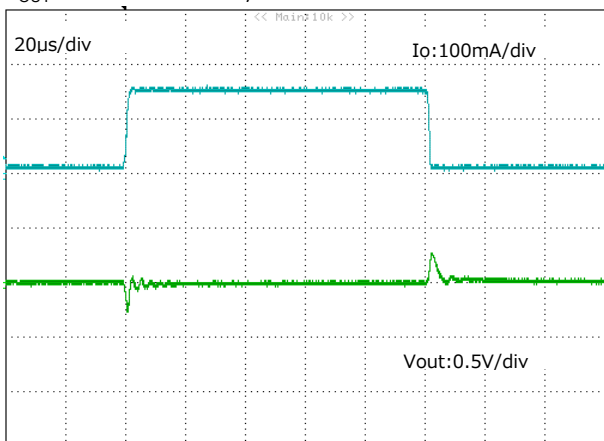

$I_{OUT} : 10mA \Leftrightarrow 150mA, C_{in}=C_{o}=None$

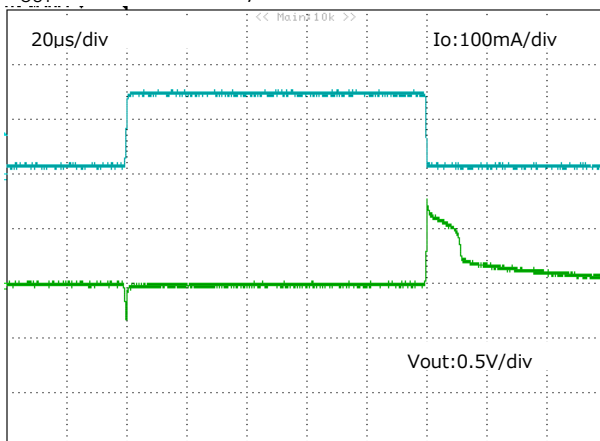



Typical Performance Characteristics (3.3V)

($V_{DD}=V_{OUT}(Typ.)+1V$, $V_{CE}=V_{DD}$, $T_a=25^{\circ}C$ unless otherwise specified)

Load transient response

($V_{DD}=V_{OUT}+1V$, $V_{CE}=V_{DD}$, $C_{in}=C_{o}=none$)

$V_{DD}=4.3V$, $I_{OUT} : 50mA \Leftrightarrow 100mA$

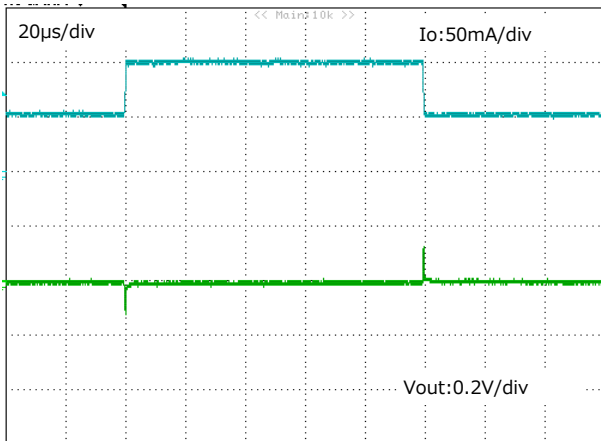

$V_{DD}=4.1V$, $I_{OUT} : 50mA \Leftrightarrow 100mA$

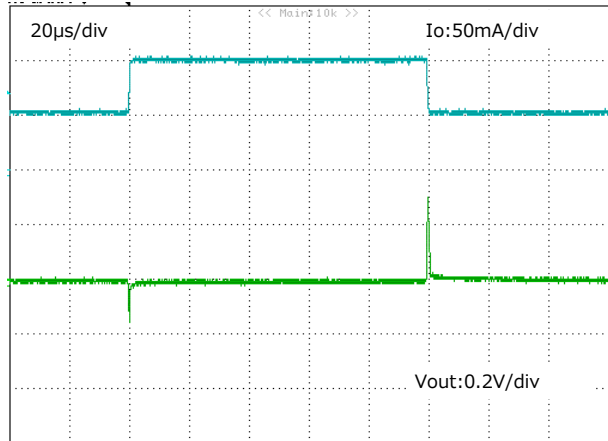

$V_{DD}=4.3V$, $I_{OUT} : 10mA \Leftrightarrow 150mA$

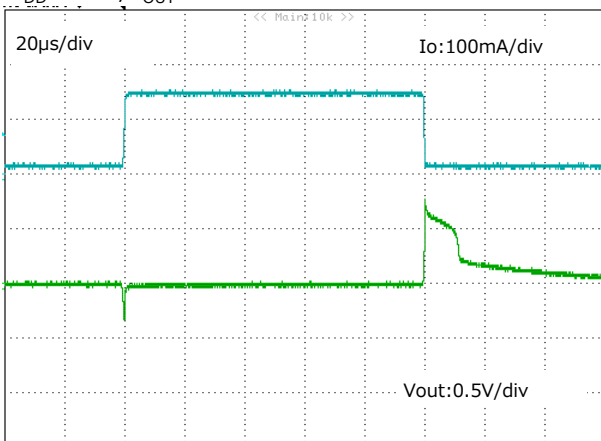

$V_{DD}=4.1V$, $I_{OUT} : 10mA \Leftrightarrow 150mA$

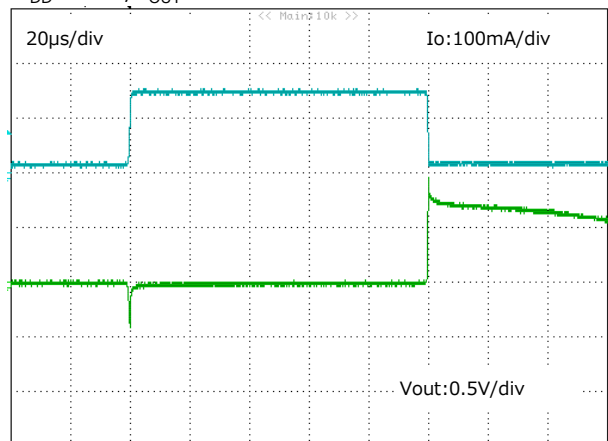

Output Rise & Rush Current

($V_{DD}=0V \rightarrow 4.3V$, $V_{CE}=V_{DD}$, $C_{in}=C_{o}=None$, $I_{OUT}=1mA$)

$t_r=1\mu s$ ($V_{DD} : 10\% \sim 90\%$)

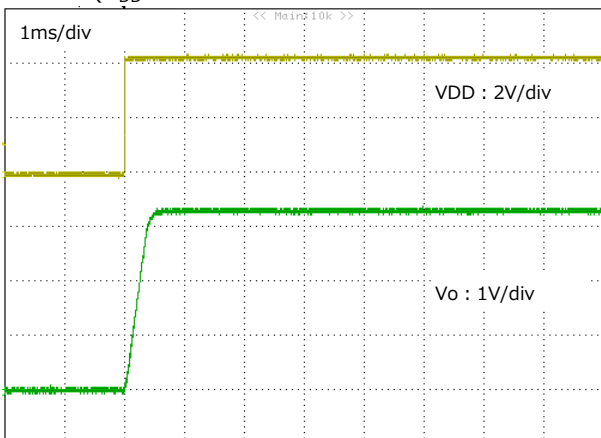

$t_r=1ms$ ($V_{DD} : 10\% \sim 90\%$)

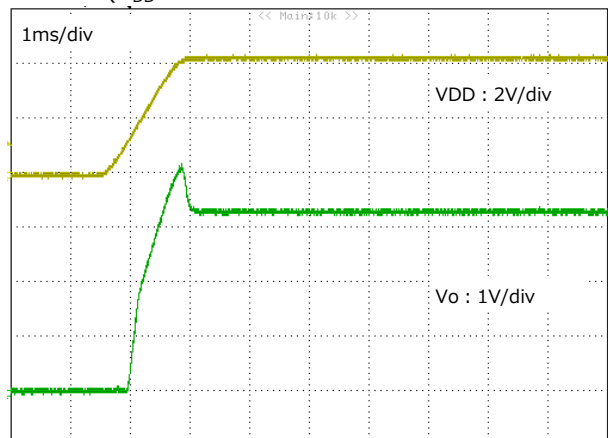



Typical Performance Characteristics (5.0V)

($V_{DD}=V_{OUT(Typ.)}+1V$, $V_{CE}=V_{DD}$, $T_a=25^\circ C$ unless otherwise specified)

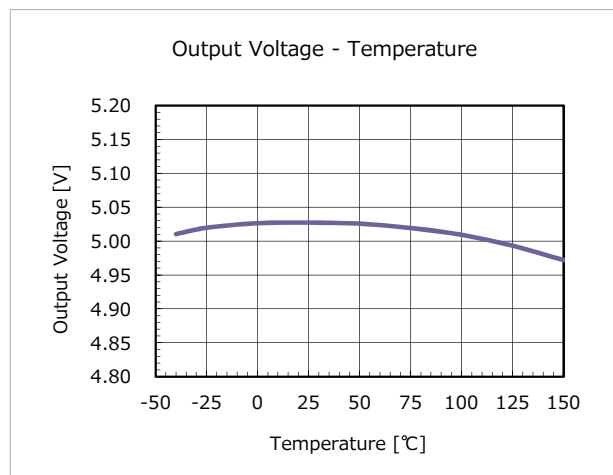
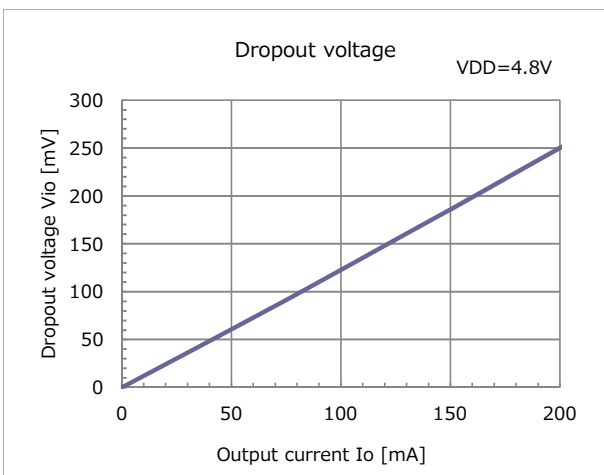
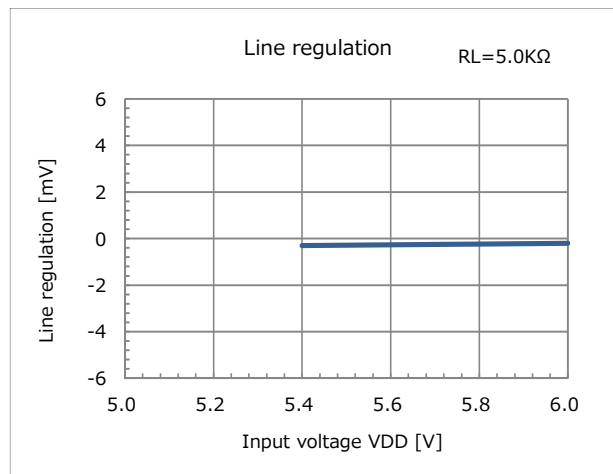
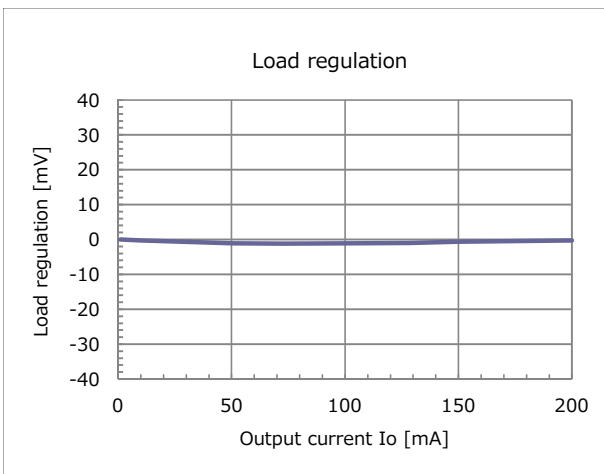
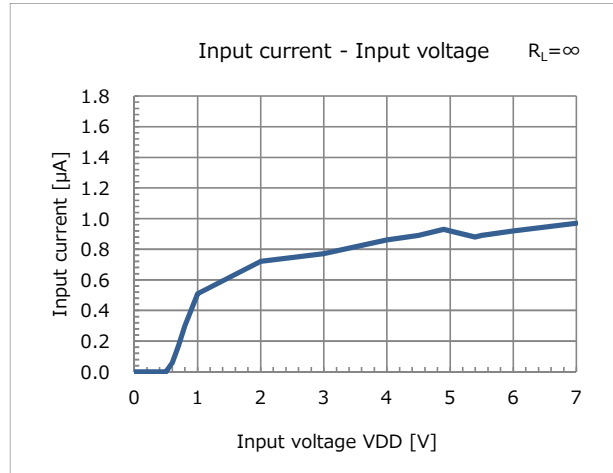
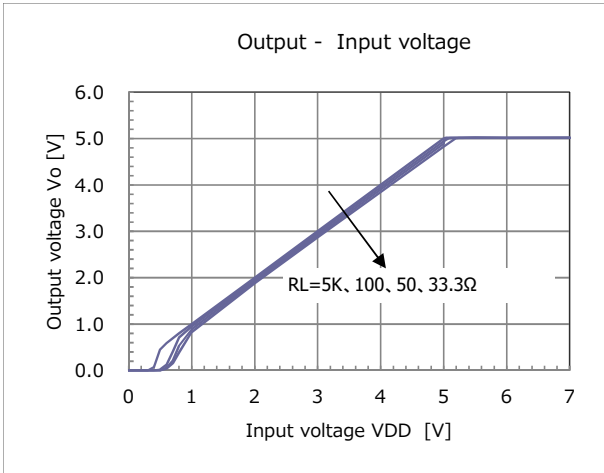



Typical Performance Characteristics (5.0V)

($V_{DD}=V_{OUT}(Typ.)+1V$, $V_{CE}=V_{DD}$, $T_a=25^\circ C$ unless otherwise specified)

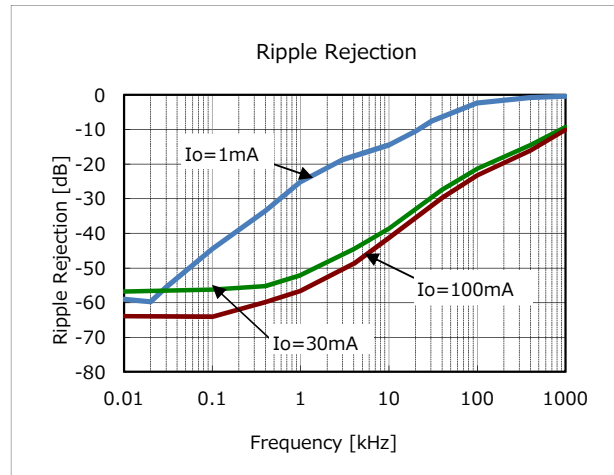
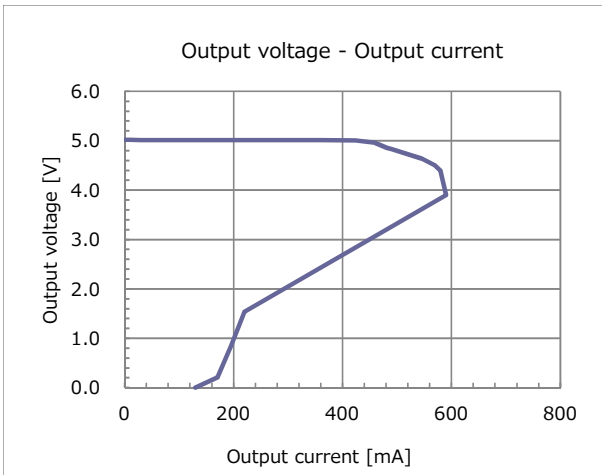



Typical Performance Characteristics (5.0V)

($V_{DD}=V_{OUT}(Typ.)+1V$, $V_{CE}=V_{DD}$, $T_a=25^{\circ}C$ unless otherwise specified)

- Load transient response

($V_{DD}=V_{OUT}+1V$, $V_{CE}=V_{DD}$)

$I_{OUT} : 50mA \leftrightarrow 100mA$, $C_{in}=C_{o}=0.1\mu F$

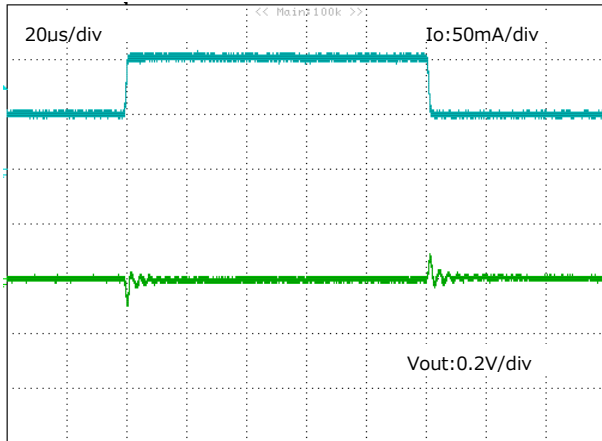

$I_{OUT} : 50mA \leftrightarrow 100mA$, $C_{in}=C_{o}=None$

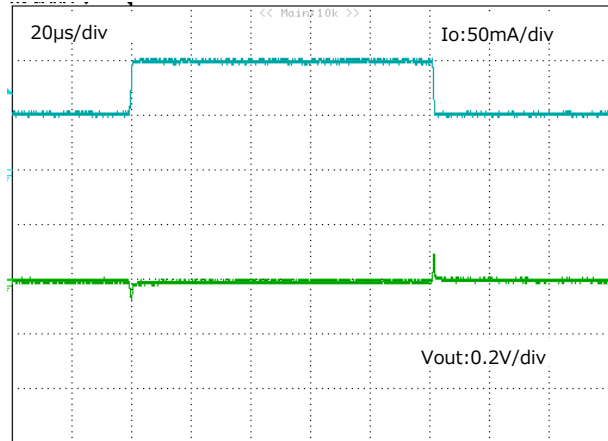

$I_{OUT} : 1mA \leftrightarrow 150mA$, $C_{in}=C_{o}=0.1\mu F$

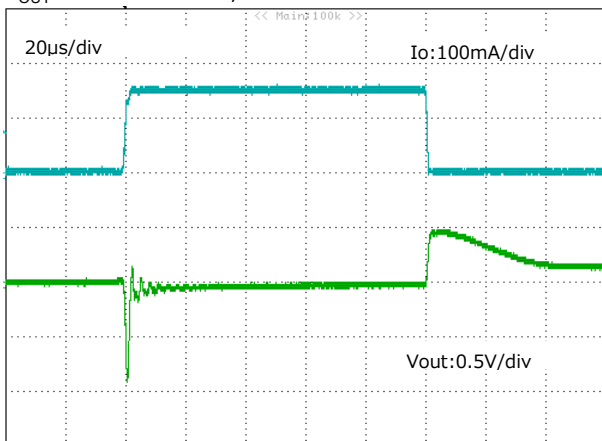

$I_{OUT} : 1mA \leftrightarrow 150mA$, $C_{in}=C_{o}=None$

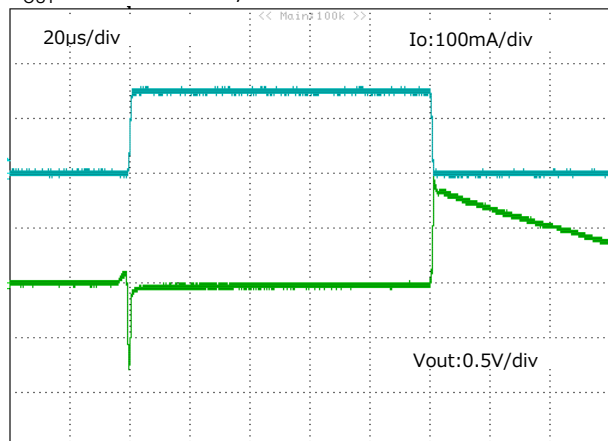

$I_{OUT} : 10mA \leftrightarrow 150mA$, $C_{in}=C_{o}=0.1\mu F$

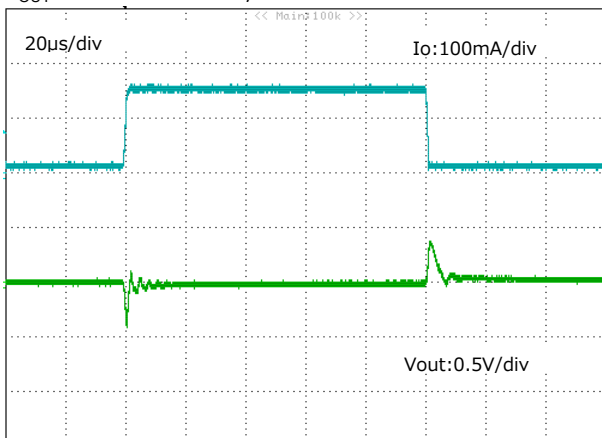

$I_{OUT} : 10mA \leftrightarrow 150mA$, $C_{in}=C_{o}=None$

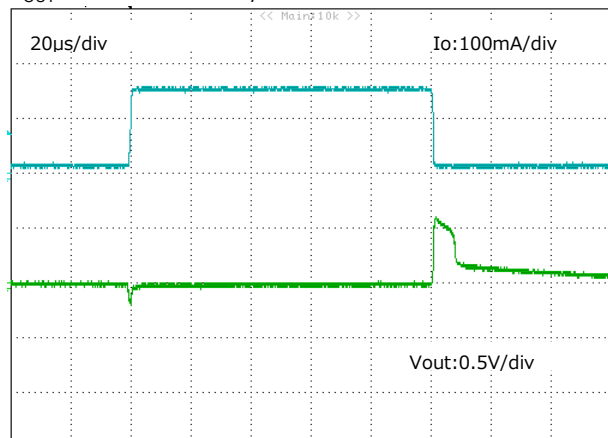



Typical Performance Characteristics (5.0V)

($V_{DD}=V_{OUT}(Typ.)+1V$, $V_{CE}=V_{DD}$, $T_a=25^{\circ}C$ unless otherwise specified)

- Load transient response

($V_{DD}=V_{OUT}+1V$, $V_{CE}=V_{DD}$, $C_{in}=C_{o}=none$)

$V_{DD}=6.0V$, $I_{OUT} : 10mA \Leftrightarrow 100mA$

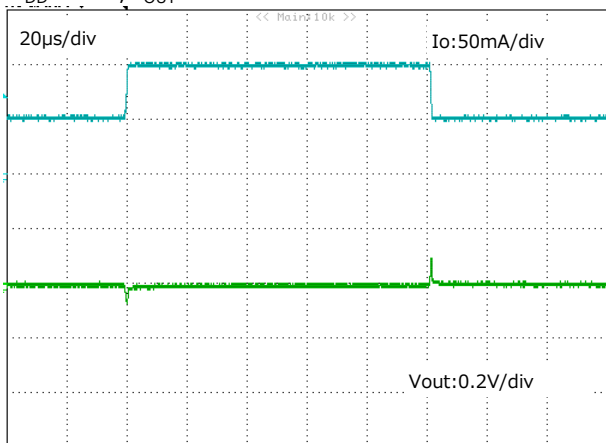

$V_{DD}=5.8V$, $I_{OUT} : 10mA \Leftrightarrow 100mA$

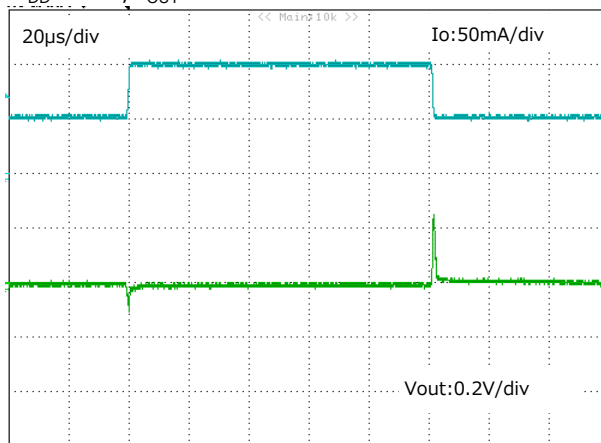

$V_{DD}=6.0V$, $I_{OUT} : 10mA \Leftrightarrow 150mA$

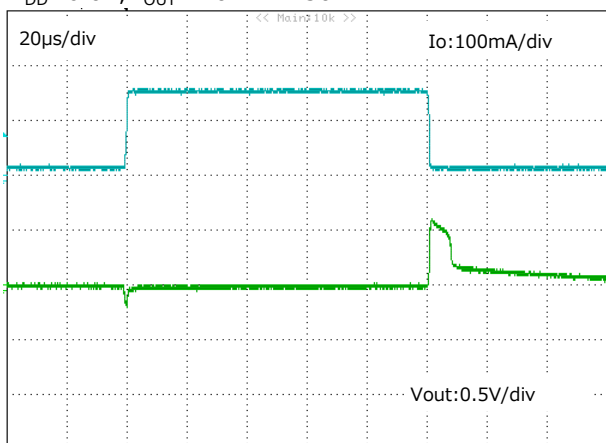

$V_{DD}=5.8V$, $I_{OUT} : 10mA \Leftrightarrow 150mA$

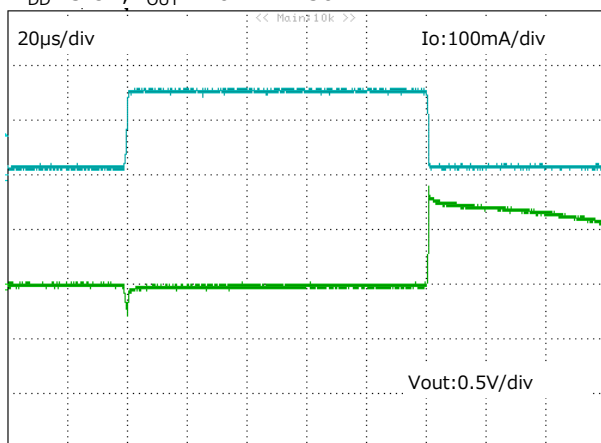

- Output Rise & Rush Current

($V_{DD}=0V \rightarrow 2.2V$, $V_{CE}=V_{DD}$, $C_{in}=C_{o}=None$, $I_{OUT}=1mA$)

$t_r=1\mu s$ ($V_{DD} : 10\% \sim 90\%$)

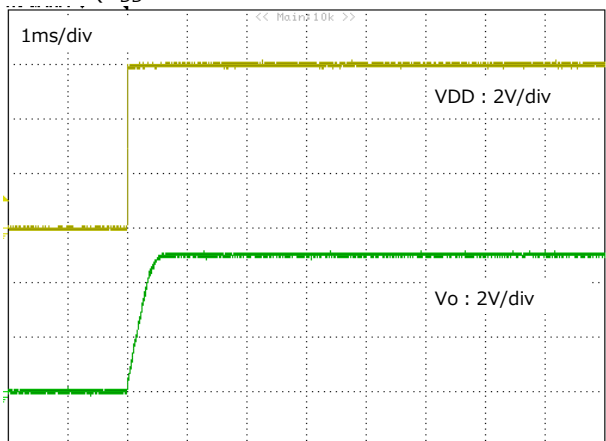

$t_r=1ms$ ($V_{DD} : 10\% \sim 90\%$)

