

16V Maximum ratings voltage, High voltage output 300mA LDO

## MM1849 Series



### Overview

This IC is a 300mA Low dropout regulator IC for 8-10V output voltage. The IC can use a power supply of blue laser is required for high output voltage.

### Features

- Over current protection
- Thermal shutdown
- 8V to 10V output

### Main specifications

- Maximum rating supply voltage : -0.3V to 16V
- Operating voltage range :  $V_{OUT}(Typ.) + V_{io\ max}$  to 14V
- Operating ambient temperature : -40°C to 85°C
- Output current : 300mA
- Input current (OFF) : Max. 1μA
- No-load input current : Typ. 75μA
- Output voltage range : 8.0V to 10.0V (0.1V step)
- Output voltage accuracy : ±2%
- Line regulation : Max. 0.1%/V ( $V_{IN} = V_{OUT}(Typ.) + 1V$  to 14V)
- Load regulation : Typ. 20mV ( $I_{OUT} = 1mA$  to 300mA)
- Dropout voltage : Typ. 0.45V ( $I_{OUT} = 300mA$ )
- PSRR : Typ. 60dB ( $f = 1kHz$ )
- Output capacitor : 1μF (Ceramic capacitor)
- Protection function : Over current protection, Thermal shutdown
- Additional function : ON/OFF control

### Packages

- SOT-25A

### Application

- Audio visual equipment
- Office equipment / Printer
- Home appliance equipment
- Power supply for blue laser diode



## Model Name

M M 1 8 4 9 X X X X X X

Series name (A) (B) (C) (D) (E)

(A)	Function Type	A	Cont=H active, without discharge function
(B)	Output voltage rank	80	Output voltage can be designated in the range from 8.0V(80) to 10.0V(B0) in 0.1V steps.
		?	
		B0	
(C)	Package	N	SOT-25A
(D)	Packing specifications 1	R	R housing (Standard)
		L	L housing
(E)	Packing specifications 2	E	Emboss tape / Halogen contained

## Block Diagram

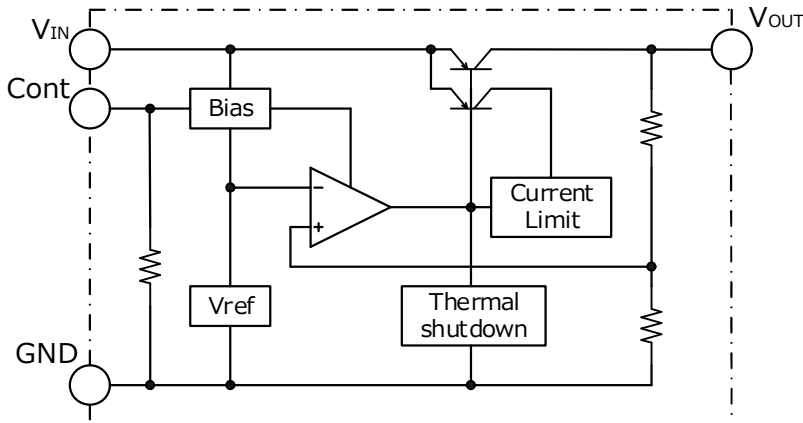

## Pin Configuration

- SOT-25A

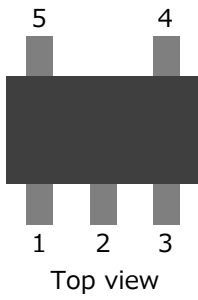

Pin No.	Pin name	Function
1	$V_{IN}$	Voltage supply pin
2	GND	GND pin
3	Cont	ON/OFF-control pin Connect Cont pin with $V_{IN}$ pin, when it is not used.
4	NC	No connection
5	$V_{OUT}$	Output pin

## Absolute Maximum Ratings

Item	Symbol	Min.	Max.	Unit
Storage temperature	Tstg	-55	150	°C
Junction temperature *Note1	Tj <sub>MAX</sub>	-	150	°C
Supply voltage	V <sub>IN</sub>	-0.3	16	V
Cont input voltage	V <sub>cont</sub>	-0.3	16	V
Output Voltage	V <sub>OUT</sub>	-0.3	V <sub>IN</sub> +0.3V	V
Output current	I <sub>omax</sub>	0	350	mA
Power Dissipation 1 *Note2	Pd1	-	350	mW
Power Dissipation 2 *Note3	Pd2	-	700	mW

\*Note1: In consideration of product life, please examine the use in less than 80%.

\*Note2: PC Board of glass epoxy 60mm×40mm t=1.6mm Copper foil area 80%

\*Note3: JEDEC51-7 standard 114.3mm×76.2mm t=1.6mm Copper foil area 80%

## Recommended Operating Conditions

Item	Symbol	Min.	Max.	Unit
Operating Ambient temperature	Topr	-40	85	°C
Operating voltage	Vop	V <sub>out(Typ.)</sub> +V <sub>io max</sub>	14.0	V
Output Current	Iop	0	300	mA

## Electrical Characteristics

(V<sub>IN</sub>=V<sub>OUT</sub>(Typ.)+1V, I<sub>out</sub>=1mA, V<sub>cont</sub>=1.6V, Ta=25°C, unless otherwise specified)

Item	Symbol	Conditions	Min.	Typ.	Max.	Unit
No-Load Input Current	I <sub>CC</sub>	I <sub>OUT</sub> =0mA V <sub>CONT</sub> =V <sub>IN</sub>	-	75	120	μA
Input Current(OFF)	I <sub>CCOFF</sub>	V <sub>CONT</sub> =0V	-	0	1	μA
Output Voltage *Note4	V <sub>OUT</sub>	I <sub>OUT</sub> =1mA	×0.98	-	×1.02	V
Dropout Voltage	V <sub>io</sub>	V <sub>IN</sub> =V <sub>OUT</sub> -0.2V I <sub>OUT</sub> =300mA	-	0.45	0.75	V
Line Regulation	V <sub>LINE</sub>	V <sub>IN</sub> =V <sub>OUT</sub> +1V~14V	-	-	0.10	%/V
Load Regulation	V <sub>LOAD</sub>	I <sub>OUT</sub> =1mA~300mA	-	20	90	mV
VOUT Temperature Coefficient *Note5	$\frac{\Delta V_{OUT}}{\Delta T_{OP}}$	-40≤Top≤85°C	-	±100	-	ppm/°C
Ripple Rejection *Note5	RR	f=1kHz, V <sub>ripple</sub> =1V I <sub>OUT</sub> =10mA	-	60	-	dB
Cont PIN Input Current	I <sub>cont</sub>		-	3	12	μA
Cont Pin High Threshold Voltage	V <sub>contH</sub>		1.6	-	-	V
Cont Pin Low Threshold Voltage	V <sub>contL</sub>		-	-	0.3	V

\*Note4: Please refer to another page.

\*Note5: The parameter is guaranteed by design.

**Electrical Characteristics**

Model name	Item			
	Output voltage			
	V <sub>OUT</sub> (V)			
	Conditions	Min.	Typ.	Max.
MM1849A80	I <sub>OUT</sub> =1mA	7.840	8.000	8.160
MM1849A81		7.938	8.100	8.262
MM1849A82		8.036	8.200	8.364
MM1849A83		8.134	8.300	8.466
MM1849A84		8.232	8.400	8.568
MM1849A85		8.330	8.500	8.670
MM1849A86		8.428	8.600	8.772
MM1849A87		8.526	8.700	8.874
MM1849A88		8.624	8.800	8.976
MM1849A89		8.722	8.900	9.078
MM1849A90		8.820	9.000	9.180
MM1849A91		8.918	9.100	9.282
MM1849A92		9.016	9.200	9.384
MM1849A93		9.114	9.300	9.486
MM1849A94		9.212	9.400	9.588
MM1849A95		9.310	9.500	9.690
MM1849A96		9.408	9.600	9.792
MM1849A97		9.506	9.700	9.894
MM1849A98		9.604	9.800	9.996
MM1849A99		9.702	9.900	10.098
MM1849AB0	9.800	10.000	10.200	

## Test Circuit

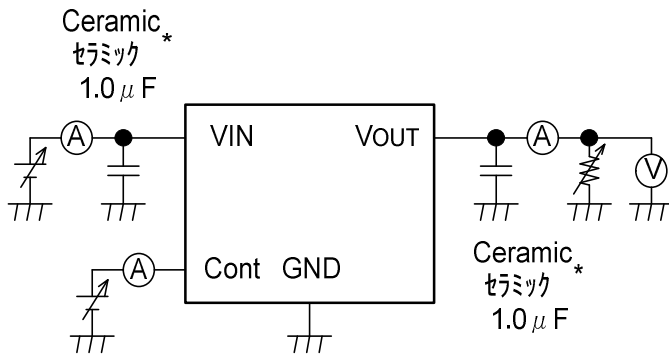

## Application Circuit

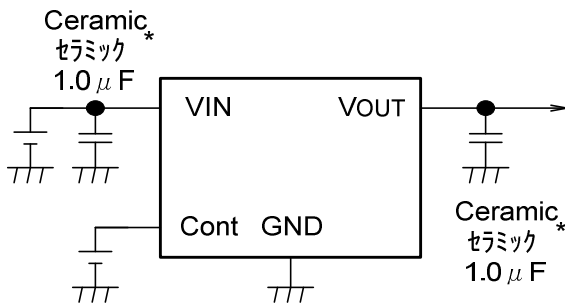

(Example of external parts)

- Output capacitor                      Ceramic capacitor 1.0μF
- Input Capacitor                      Ceramic capacitor 1.0μF

\*Temperature characteristics : B

- In the event a problem which may affect industrial property or any other rights of us or a third party is encountered during the use of information described in these circuit, we shall not be liable for any such problem, nor grant a license therefore.

## Note

1. Please use this IC within the stated absolute maximum ratings.  
The IC is liable to malfunction should the ratings be exceeded.
2. There is a possibility that it becomes impossible to maintain this performance and reliability IC original when using exceeding recommended operation voltage.  
Please use it in recommended operation voltage.
3. Due to restrictions on the package power dissipation, the output current value may not be satisfied.  
Attention should be paid to the power dissipation of the package when the output current is large or the voltage between Input and Output is high.
4. The output capacitor is required between output and GND to prevent oscillation.
5. The ESR of capacitor must be defined in ESR stability area.  
It is possible to use a ceramic capacitor without ESR resistance for output.  
The ceramic capacitor must be used more than 1.0 $\mu$ F and B temperature characteristics.
6. The wire of Vin and GND is required to print full ground plane for noise and stability.
7. The input capacitor must be connected a distance of less than 1cm from input pin.
8. It is able to an unstable operation when you use the capacitor with intense capacitance change .  
The capacitor has the dependency at the power-supply voltage and the temperature.  
The capacity value changes by the environment used. Please evaluate IC in the set.
9. In case the output voltage is above the input voltage, the overcurrent flow by internal parasitic diode from output to input. In such application, the external bypass diode must be connected between output and input pin.

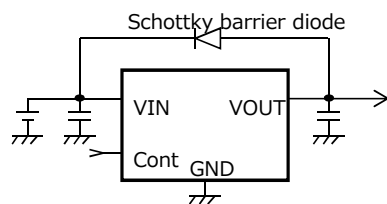

10. There is a possibility of becoming an unstable operation. when using it with Dropout voltage no margin.  
Please evaluate it enough when there is no margin in Dropout voltage.
11. The overcurrent protection circuit of the vertical type is built into this IC.
12. There is a possibility that IC generates heat when the output terminal is short-circuited.  
However, the thermal shutdown circuit operates, and it will do operation that protects IC.  
The thermal shutdown circuit is designed only to shut the IC off to prevent thermal runaway.  
Do not continue to use the IC in an environment where the operation of this circuit is assumed.  
The characteristic changes depending on the substrate condition.
13. The hysteresis circuit is not built into the thermal shutdown circuit.  
It returns automatically in temperature returned after it shuts down by self-generation of heat.  
After it returns, it shuts down again by self-generation of heat.  
It is necessary to change the environment used (IC consumption, temperature) if it operates in upper cycle.

## About Power Dissipation

The Power dissipation change if board to mount IC change because radiative heat fix at board. It is reference data below, Evaluate IC in the set.

- SOT-25A
  1. PC Board of glass epoxy
 

Board size	60mm×400mm	t=1.6mm	Copper foil area 60%
Power dissipation	350mW	Ta=25°C	
  2. JEDEC51-7 standard (4 layer FR-4 board)
 

Board size	114.3mm×76.2mm	t=1.6mm	Copper foil area 80%
Power dissipation	700mW	Ta=25°C	

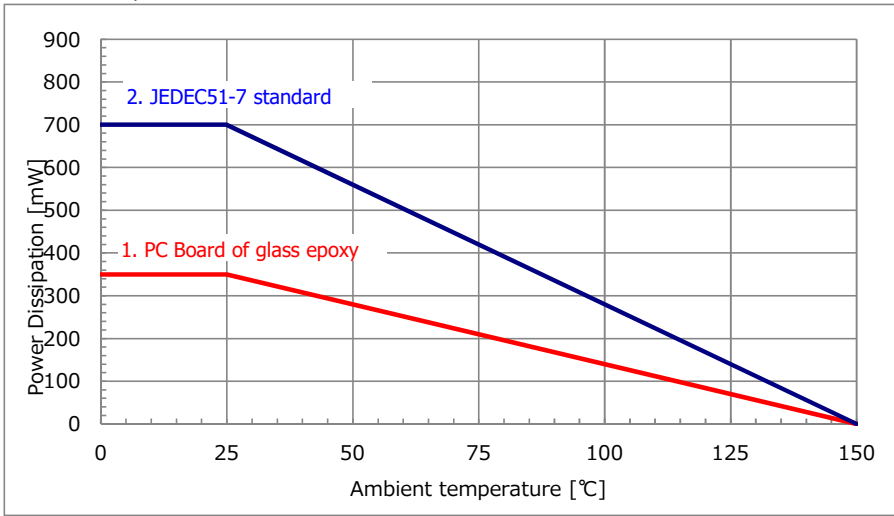

It is recommended to layout the VIA for heat radiation in the GND pattern of reverse (of IC) when there is the GND pattern in the inner layer (in using multiplayer substrate). By increasing these copper foil pattern area of PCB, Power dissipation improves.



## Typical Performance Characteristics (V<sub>OUT</sub>=8.0V)

(V<sub>IN</sub>=V<sub>OUT</sub>(Typ.)+1V, I<sub>out</sub>=1mA, V<sub>Cont</sub>=1.6V, T<sub>a</sub>=25°C unless otherwise specified)

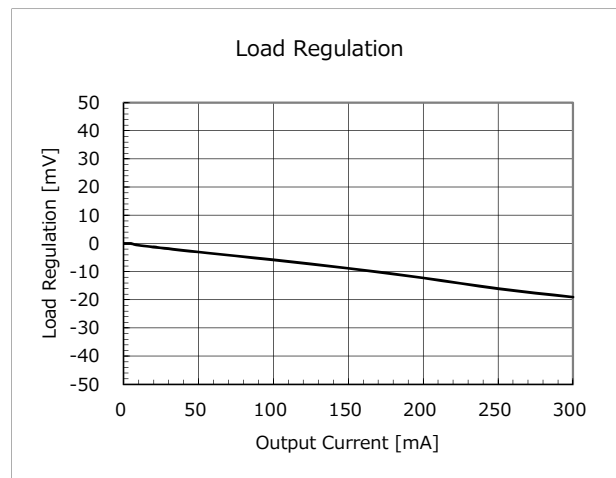
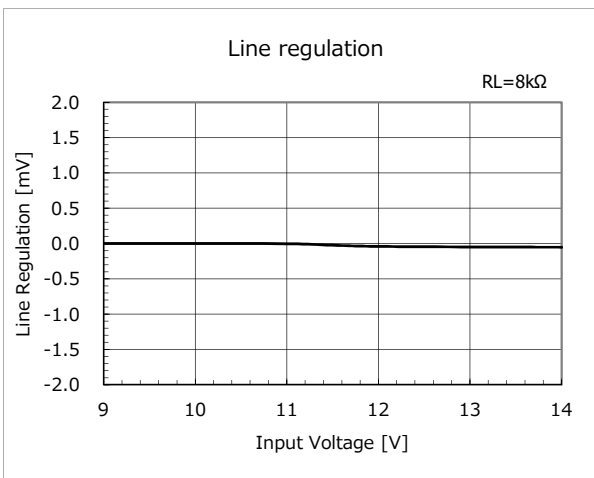
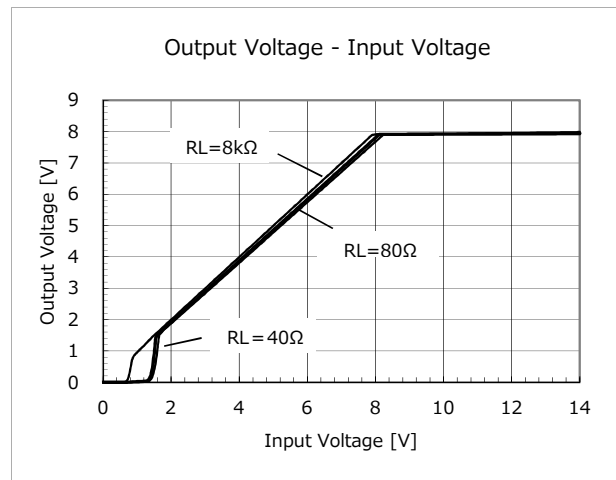
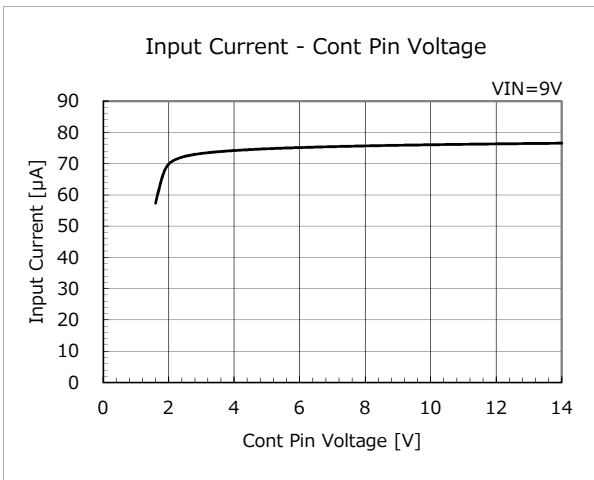
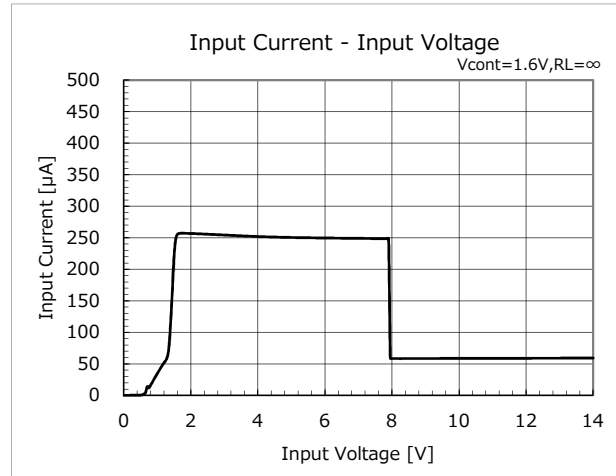
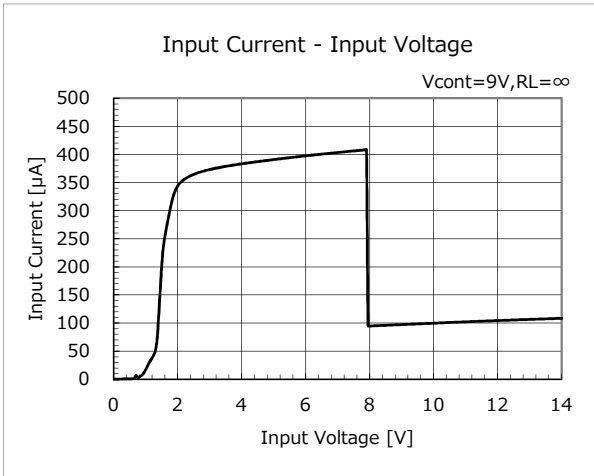

## Typical Performance Characteristics (V<sub>OUT</sub>=8.0V)

(V<sub>IN</sub>=V<sub>OUT</sub>(Typ.)+1V, I<sub>out</sub>=1mA, V<sub>Cont</sub>=1.6V, T<sub>a</sub>=25°C unless otherwise specified)

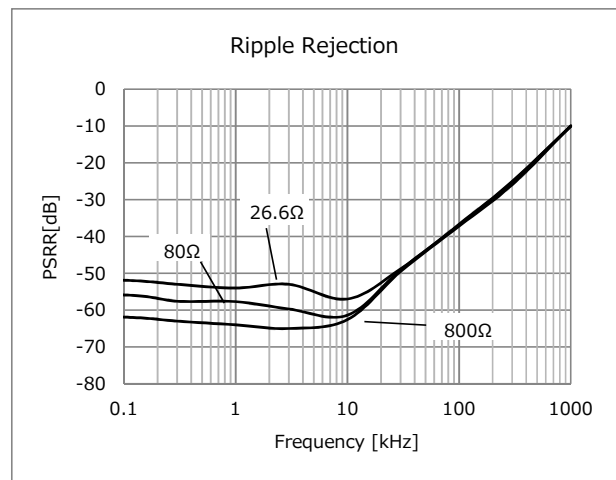
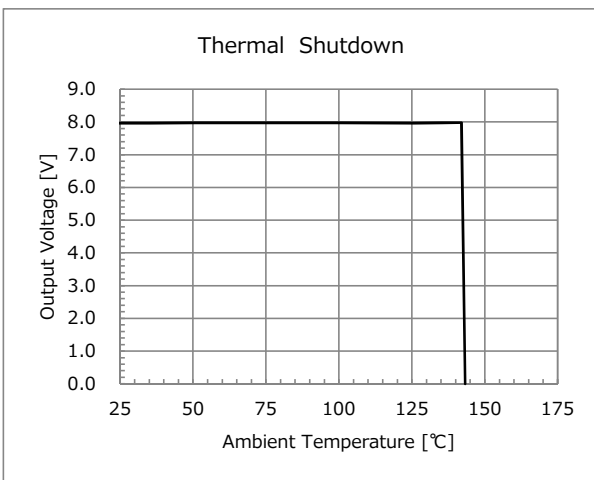
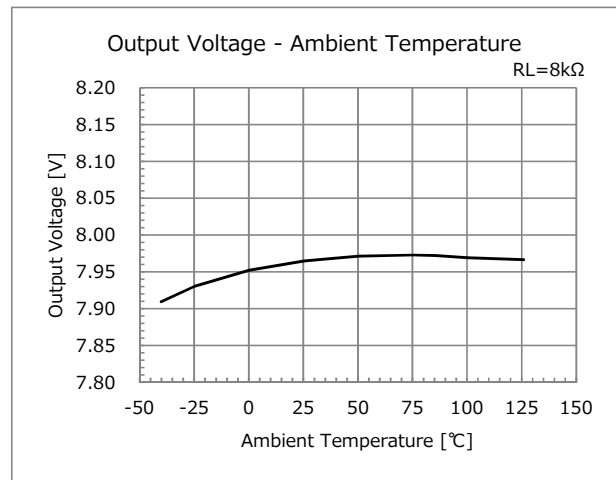
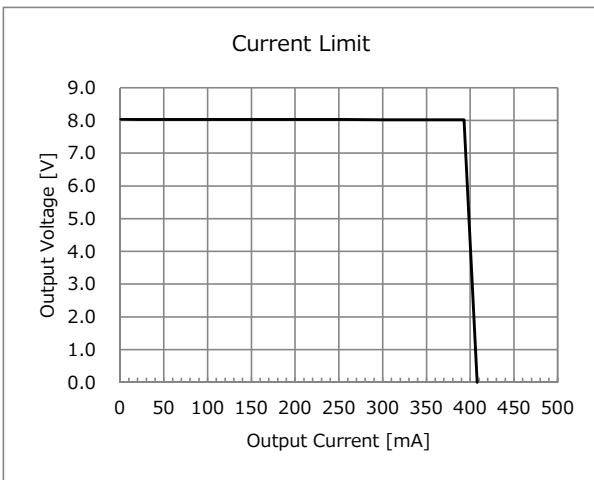
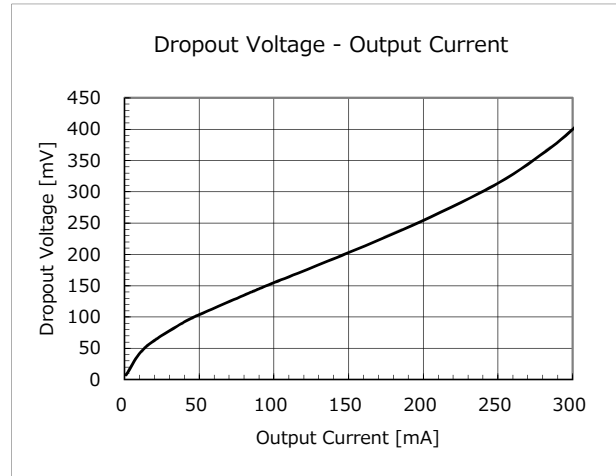
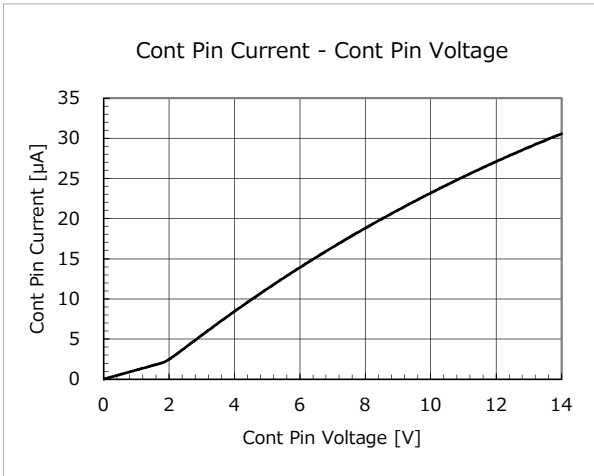

## Typical Performance Characteristics (V<sub>OUT</sub>=8.0V)

(V<sub>IN</sub>=V<sub>OUT</sub>(Typ.)+1V, I<sub>out</sub>=1mA, V<sub>Cont</sub>=1.6V, T<sub>a</sub>=25°C unless otherwise specified)

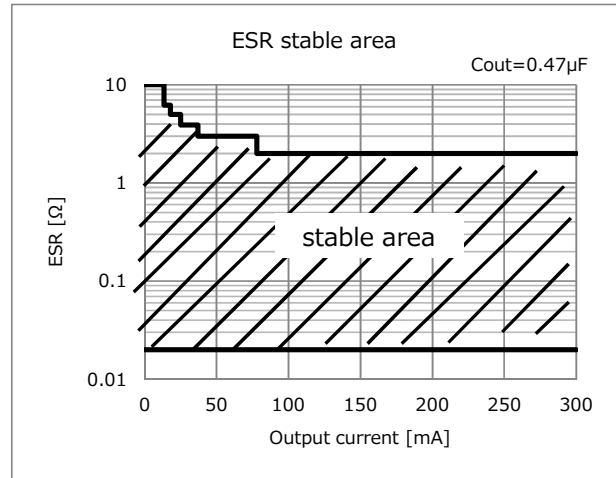
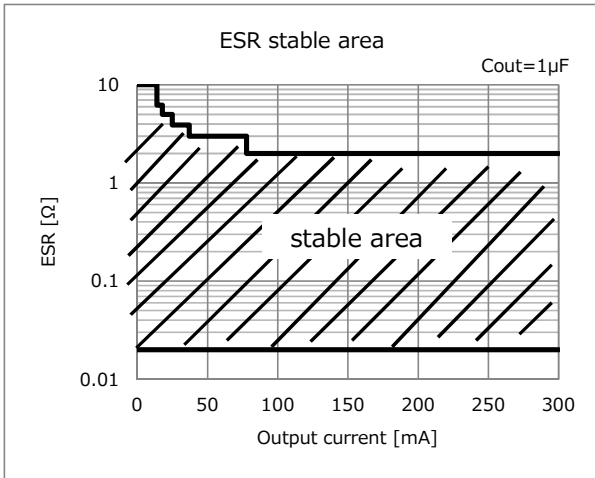

- Turn - On Transient response  
V<sub>IN</sub>=9V, V<sub>cont</sub>=0V→2V, R<sub>L</sub>=8kΩ

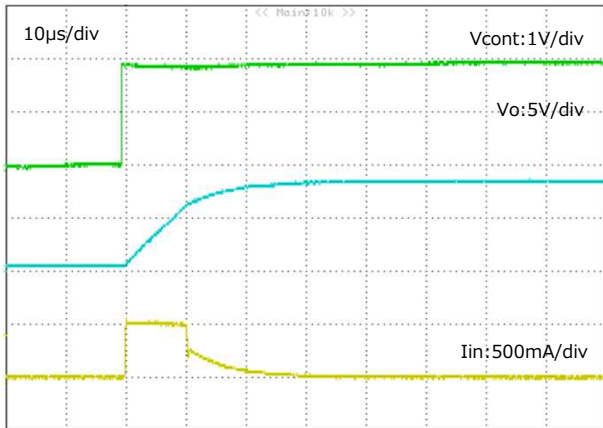

- Turn - Off Transient response  
V<sub>IN</sub>=9V, V<sub>cont</sub>=2V→0V, R<sub>L</sub>=8kΩ

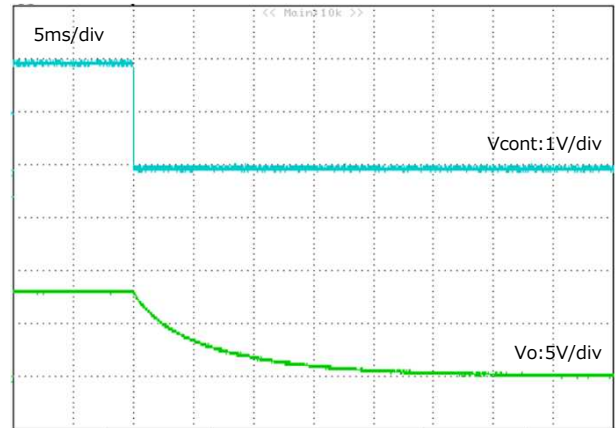

- Load transient response  
I<sub>out</sub>=1mA↔100mA

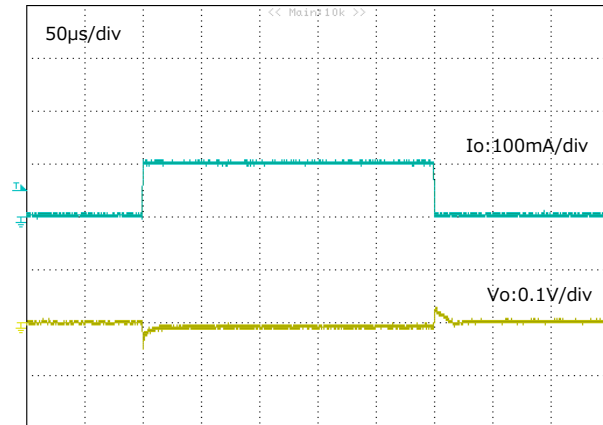

- I<sub>out</sub>=1mA↔300mA

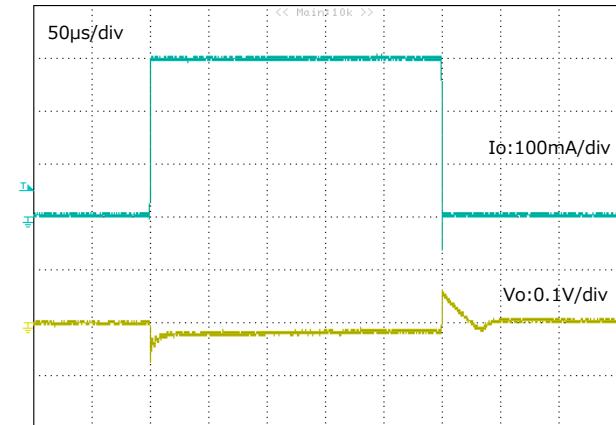

## Typical Performance Characteristics (V<sub>OUT</sub>=9.0V)

(V<sub>IN</sub>=V<sub>OUT</sub>(Typ.)+1V, I<sub>out</sub>=1mA, V<sub>Cont</sub>=1.6V, T<sub>a</sub>=25°C unless otherwise specified)

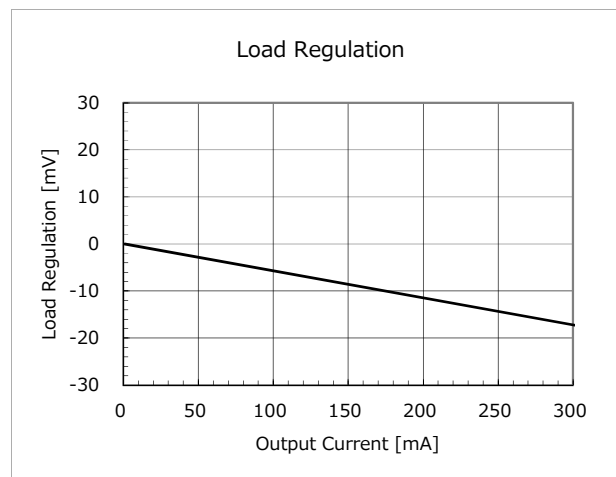
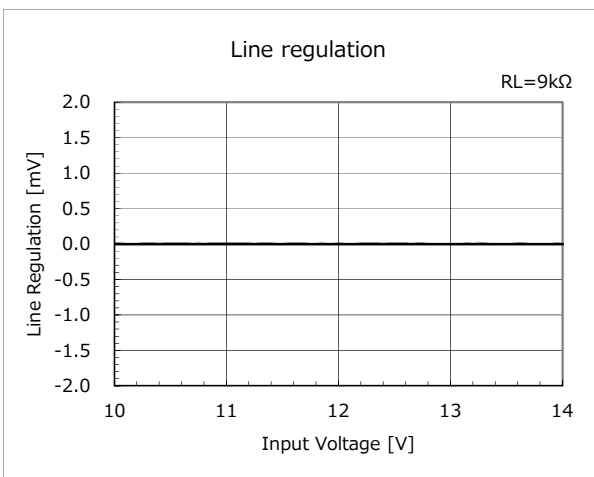
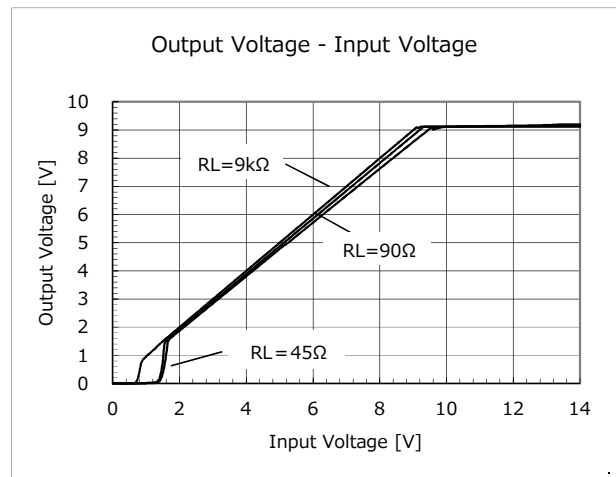
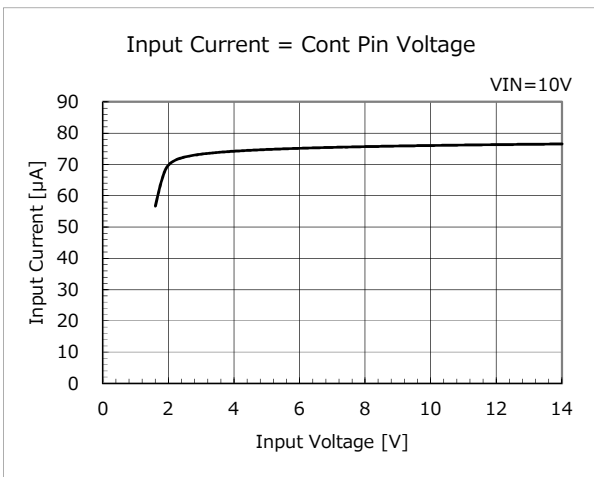
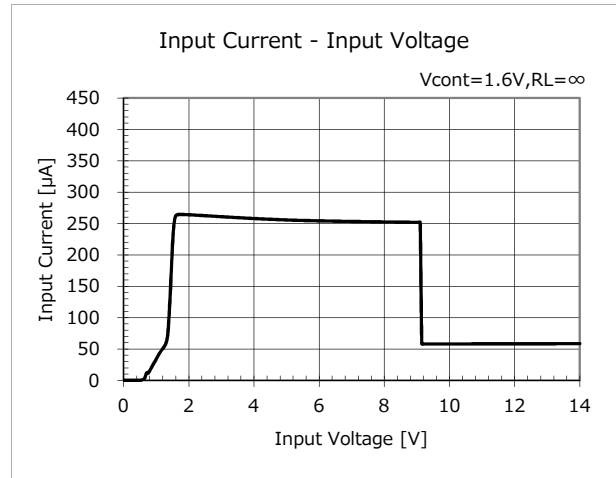
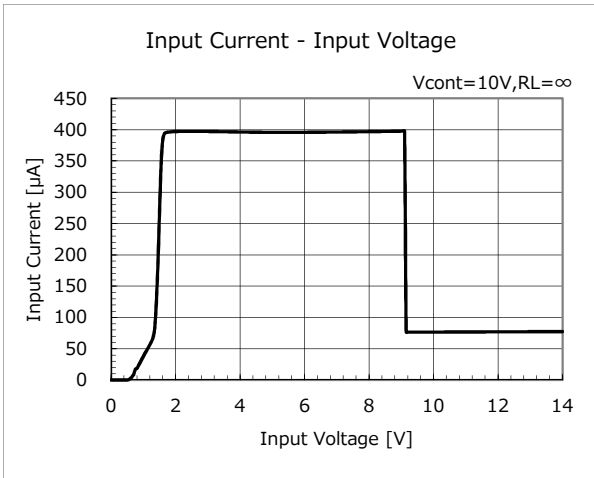

## Typical Performance Characteristics (V<sub>OUT</sub>=9.0V)

(V<sub>IN</sub>=V<sub>OUT</sub>(Typ.)+1V, I<sub>out</sub>=1mA, V<sub>Cont</sub>=1.6V, T<sub>a</sub>=25°C unless otherwise specified)

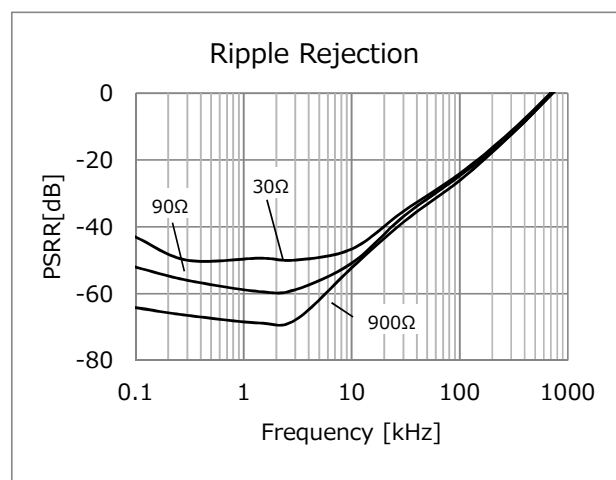
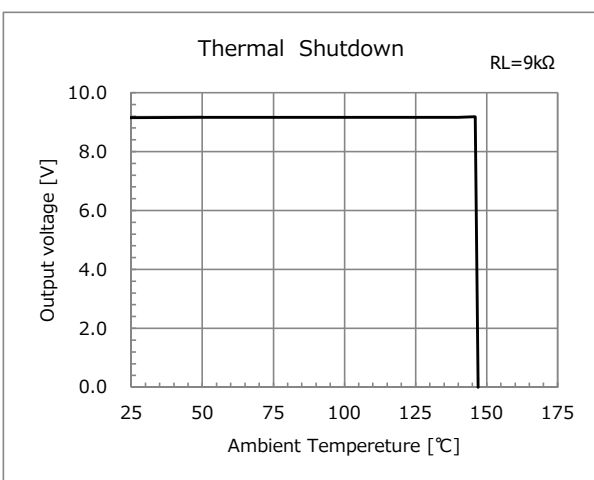
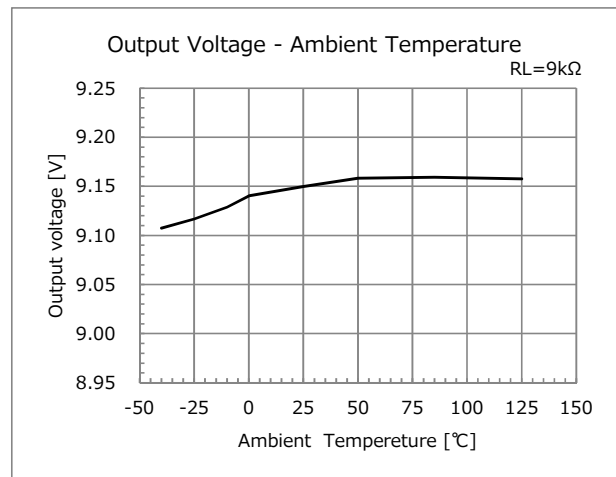
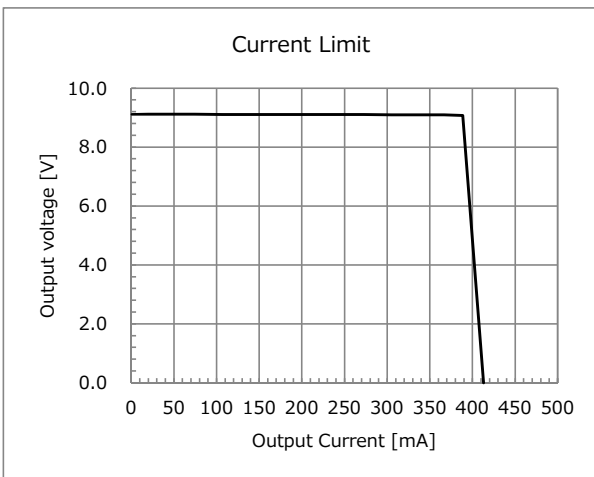
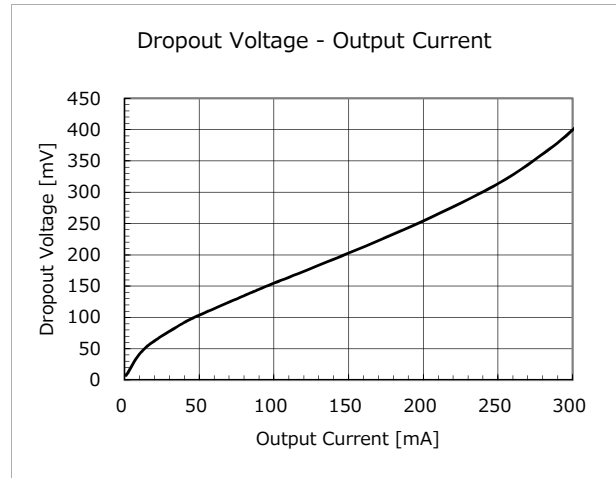
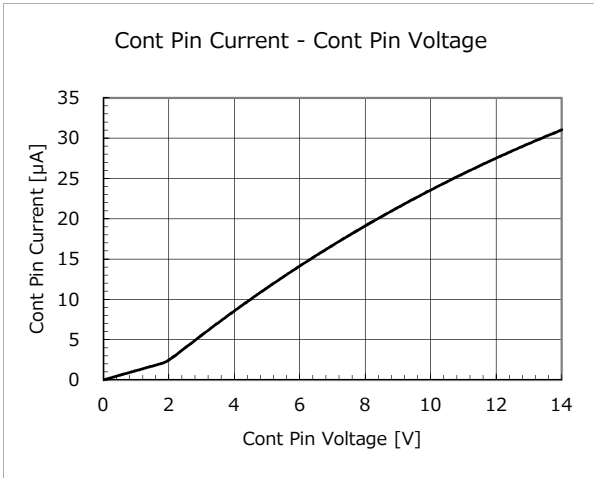

## Typical Performance Characteristics (V<sub>OUT</sub>=9.0V)

(V<sub>IN</sub>=V<sub>OUT</sub>(Typ.)+1V, I<sub>out</sub>=1mA, V<sub>Cont</sub>=1.6V, T<sub>a</sub>=25°C unless otherwise specified)

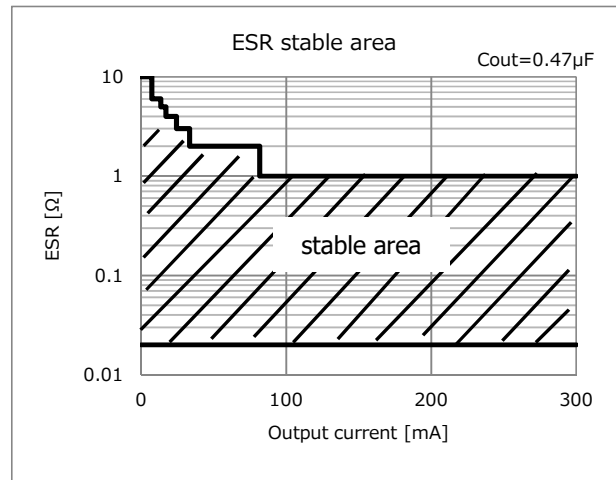
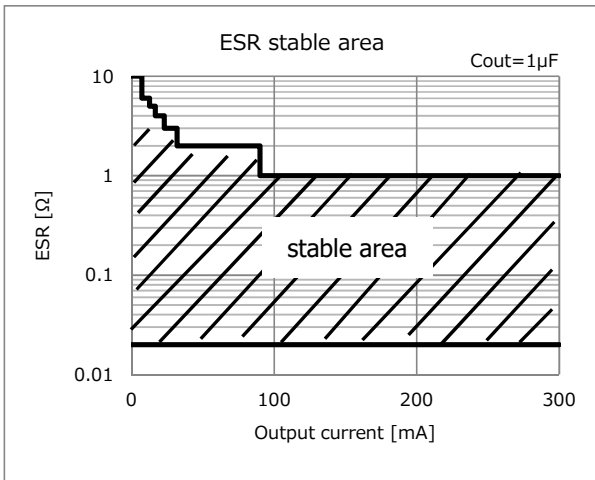

- Turn - On Transient response  
V<sub>IN</sub>=10V, V<sub>cont</sub>=0V→2V, R<sub>L</sub>=9kΩ

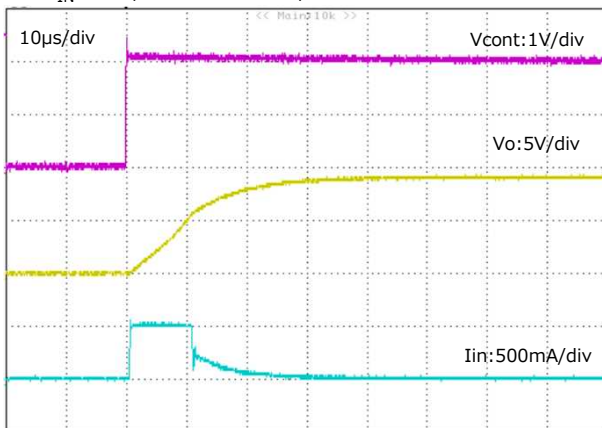

- Turn - Off Transient response  
V<sub>IN</sub>=10V, V<sub>cont</sub>=2V→0V, R<sub>L</sub>=9kΩ

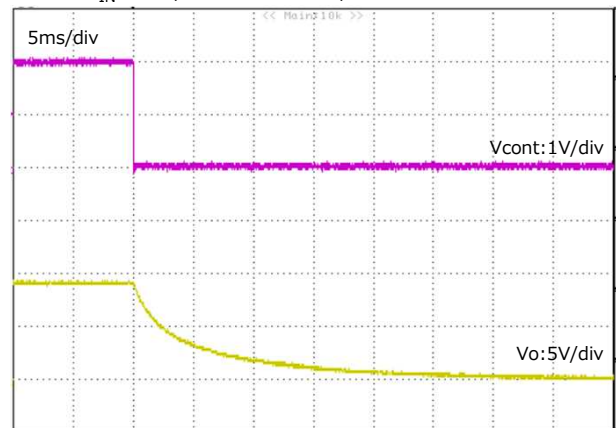

- Load transient response  
I<sub>out</sub>=1mA↔100mA

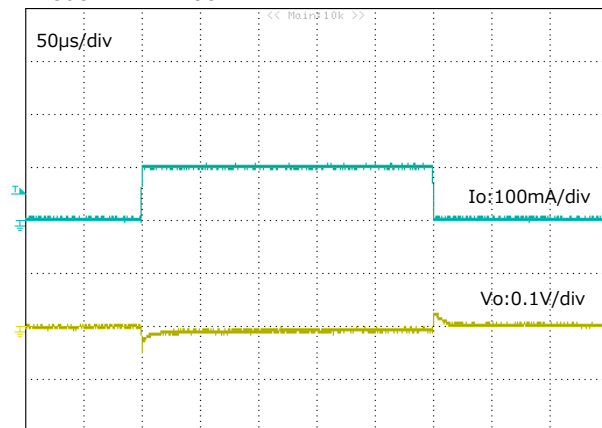

- I<sub>out</sub>=1mA↔300mA

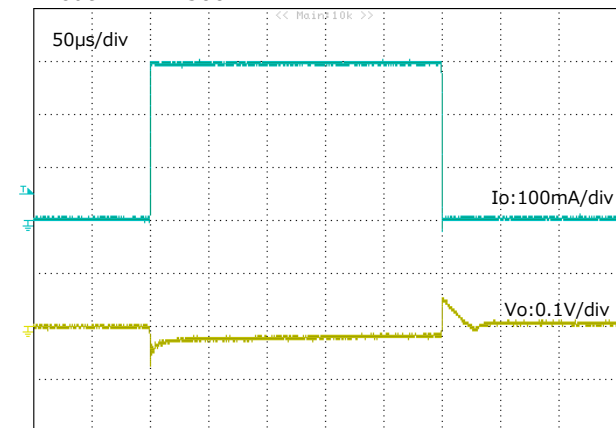

## Typical Performance Characteristics (V<sub>OUT</sub>=10.0V)

(V<sub>IN</sub>=V<sub>OUT</sub>(Typ.)+1V, I<sub>out</sub>=1mA, V<sub>Cont</sub>=1.6V, T<sub>a</sub>=25°C unless otherwise specified)

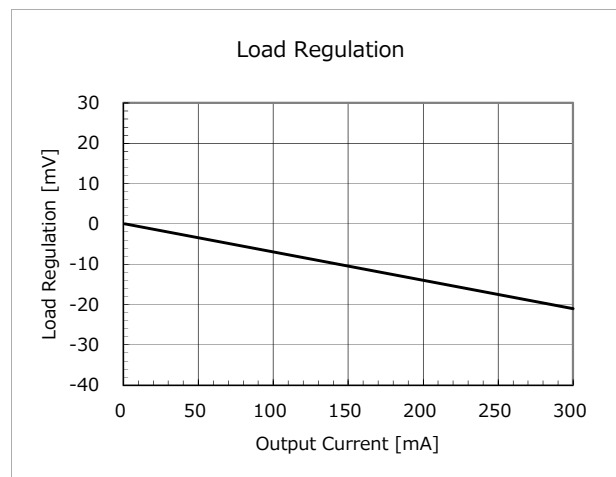
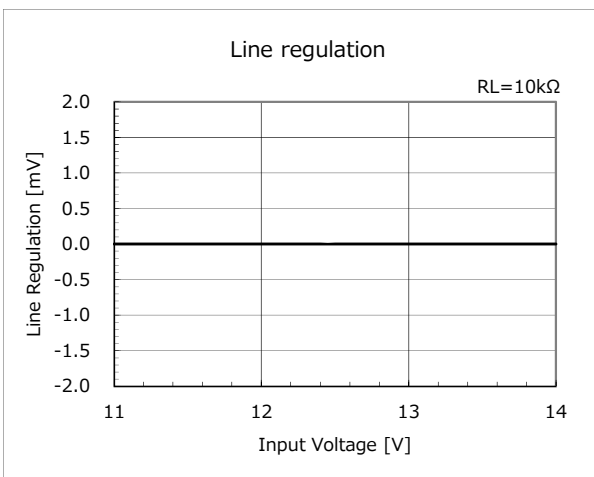
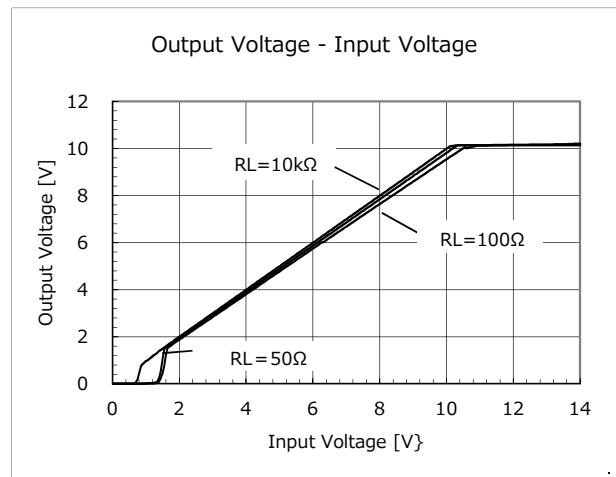
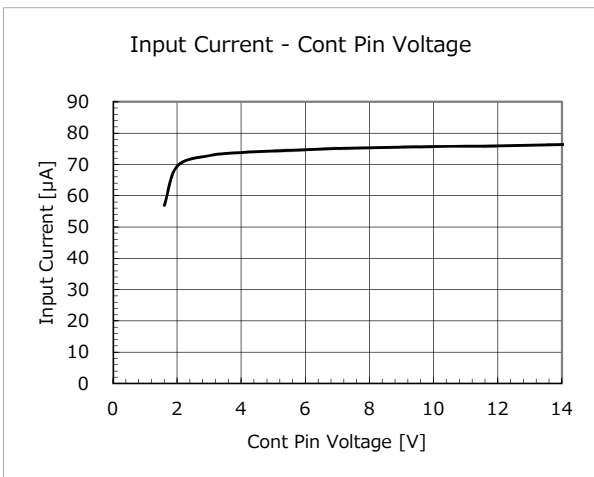
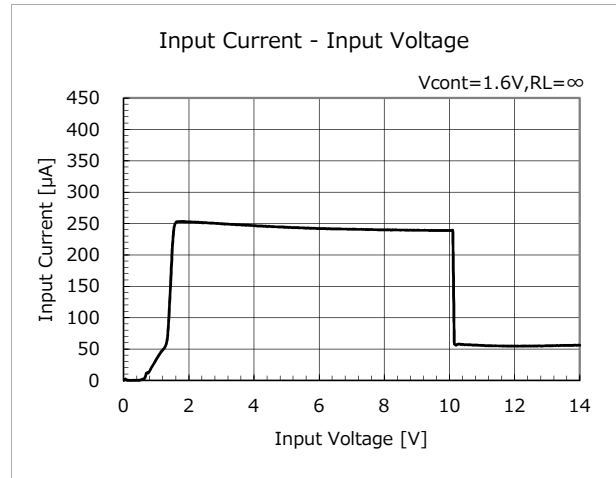
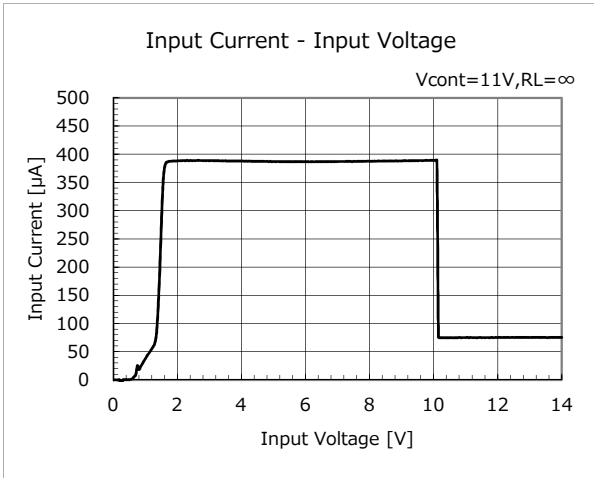

## Typical Performance Characteristics (V<sub>OUT</sub>=10.0V)

(V<sub>IN</sub>=V<sub>OUT</sub>(Typ.)+1V, I<sub>out</sub>=1mA, V<sub>Cont</sub>=1.6V, Ta=25°C unless otherwise specified)

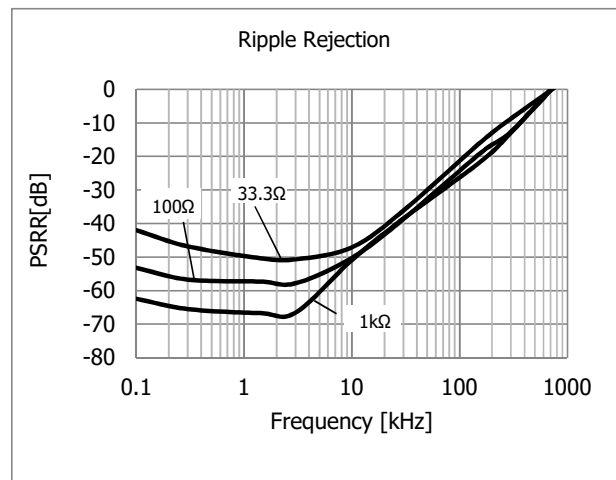
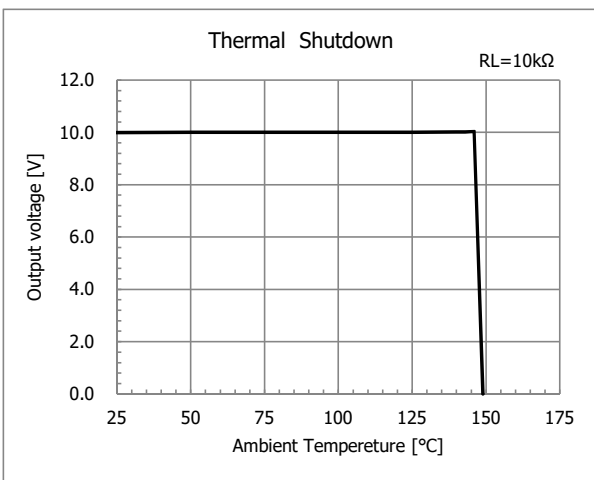
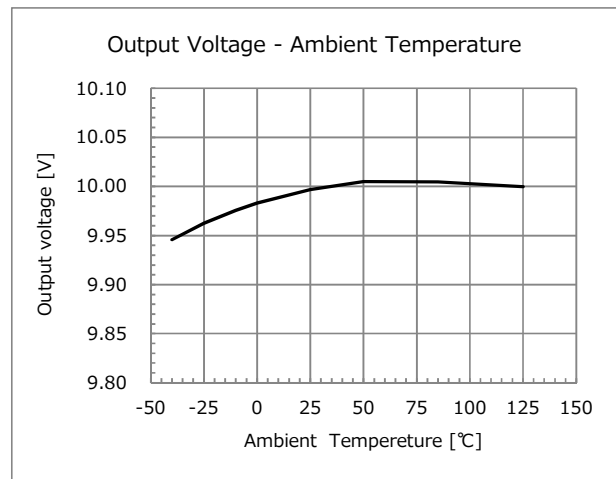
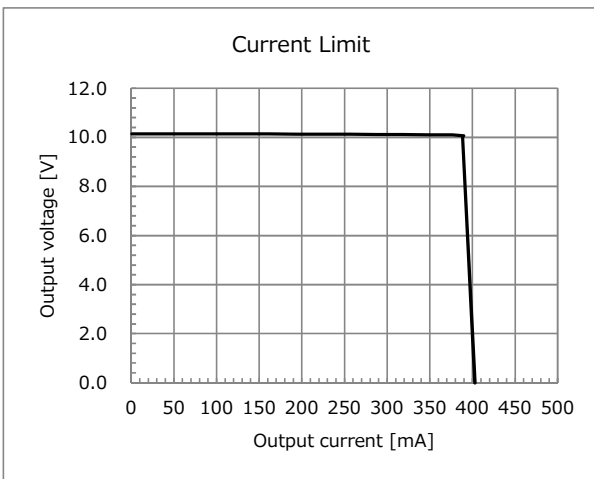
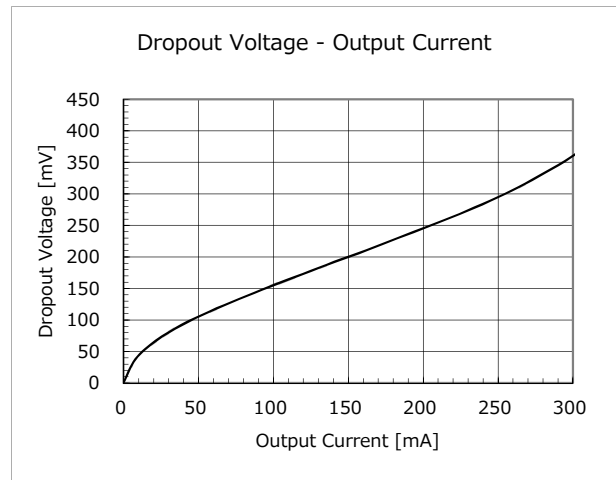
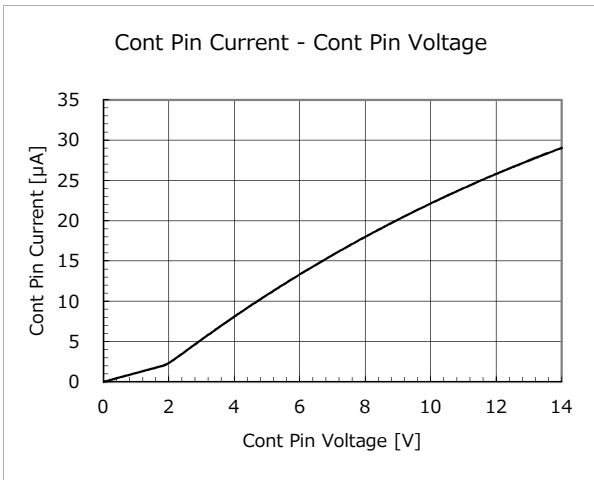



## Typical Performance Characteristics (V<sub>OUT</sub>=10.0V)

(V<sub>IN</sub>=V<sub>OUT</sub>(Typ.)+1V, I<sub>out</sub>=1mA, V<sub>Cont</sub>=1.6V, T<sub>a</sub>=25°C unless otherwise specified)

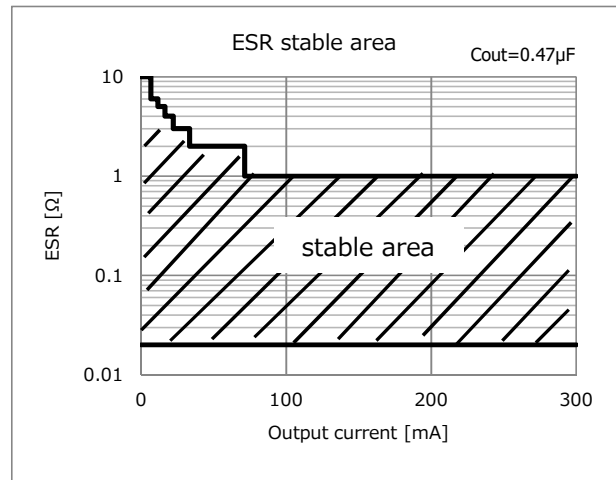
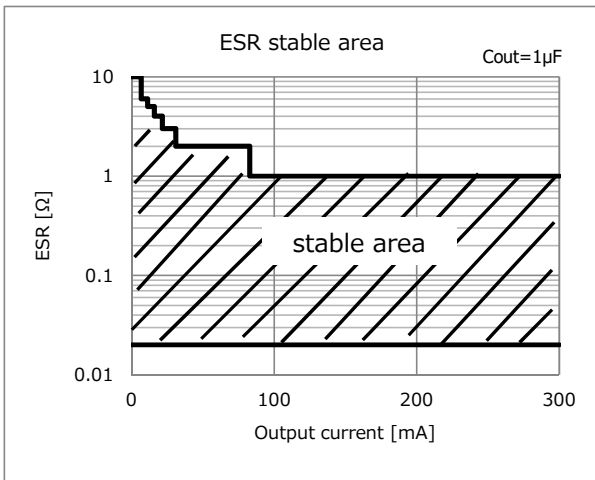

- Turn - On Transient response  
V<sub>IN</sub>=11V, V<sub>cont</sub>=0V→2V, R<sub>L</sub>=10kΩ

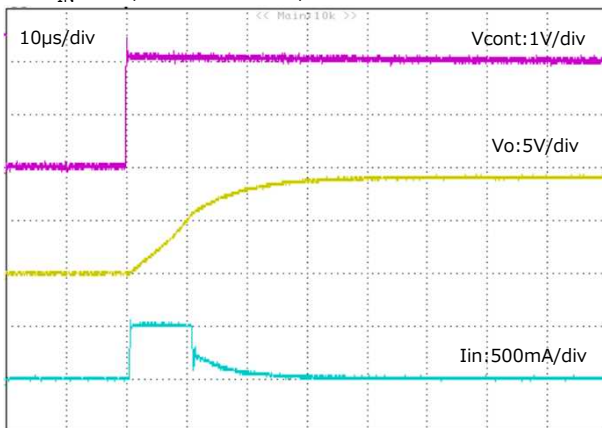

- Turn - Off Transient response  
V<sub>IN</sub>=11V, V<sub>cont</sub>=2V→0V, R<sub>L</sub>=10kΩ

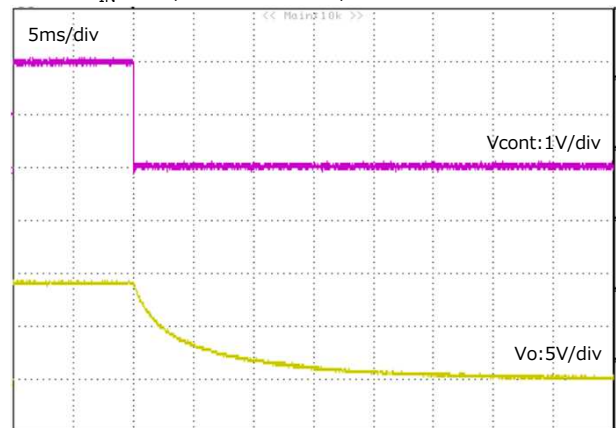

- Load transient response  
I<sub>out</sub>=1mA↔100mA

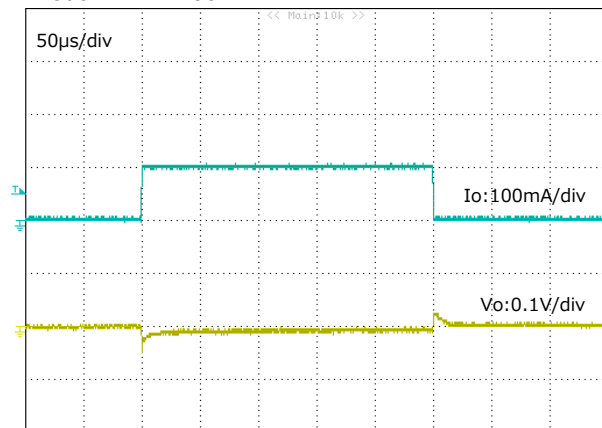

- I<sub>out</sub>=1mA↔300mA

