

# IC for Regulator+Reset Monolithic IC MM1688 Series

## Outline

This IC is a regulator (2 circuits) + reset IC developed for optical disc drives such as DVD-ROM drives. Regulator output voltage and reset detection voltage are fixed, while regulator output voltage and reset detection voltage are programmable ranging from 1.5V to 5.0V, and 2.7V to 5.0V respectively upon request.

## Features

1. Output voltage accuracy                     $\pm 2\%$
2. Dropout voltage                            0.06V typ. ( $I_o=70\text{mA}$ , regulator 1, 2)
3. Large output current                      300mA max.
4. High ripple rejection                      80dB typ. (regulator 1, 2)
5. Incorporates thermal shutdown circuit
6. Incorporates current limit circuit
7. Reset detection voltage                    1.5 to 5.0V
8. Delay time from voltage detection to reset release can be easily programmed.

## Packages

1. SOP-8D
2. HSOP-8A

## Applications

1. CD-ROM drive
2. Optical disc drivers

## Pin Assignment

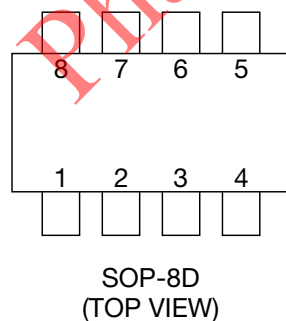

1	Cd
2	Reset
3	Vdet
4	V <sub>IN</sub>
5	V <sub>o1</sub>
6	V <sub>o2</sub>
7	GND
8	CONT

Block Diagram

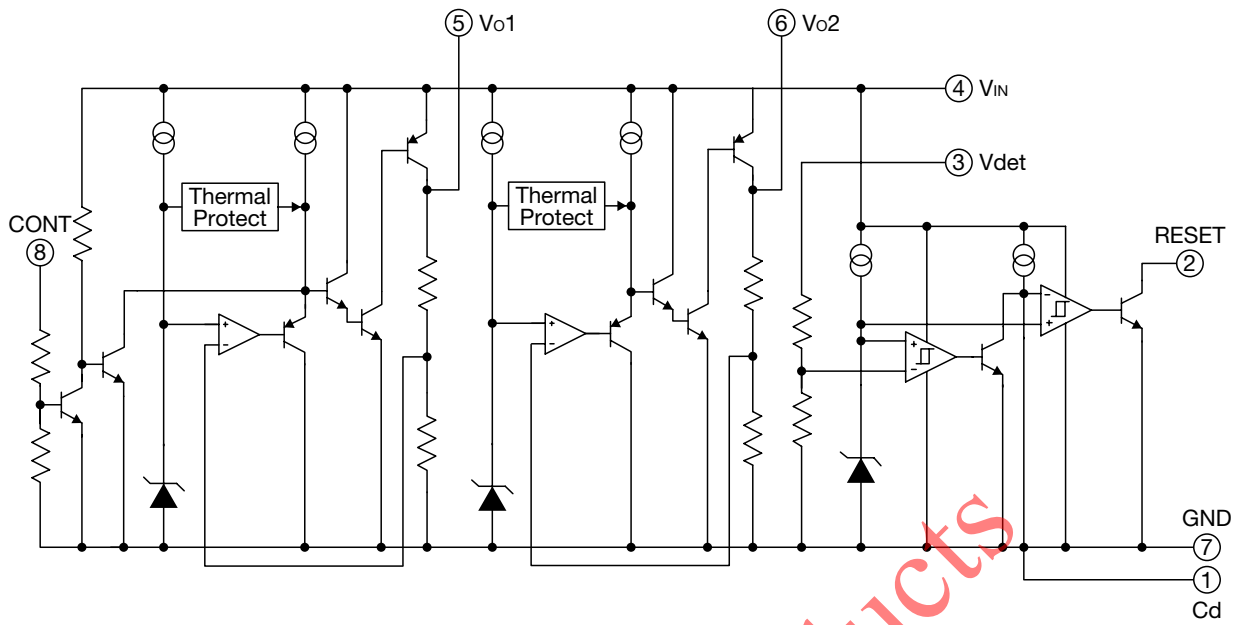

Pin Assignment

Pin No.	Pin name	Function	Internal equivalent circuit diagram						
1	Cd	<p>Delay time capacitor pin</p> <p>The delay time of RESET output can be set according to the capacity value connected with Cd.</p> $t_{PLH} = 450000 \cdot C$ <p><math>t_{PLH}</math>: Delay time (s) C: cd-capacitance (F)</p>							
2	RESET	<p>Reset-output pin</p> <p>RESET Logical table</p> <table border="1"> <tr> <td></td> <td>RESET</td> </tr> <tr> <td>Vdet &lt; VS</td> <td>L</td> </tr> <tr> <td>Vdet &gt; VS</td> <td>H</td> </tr> </table> <p>When the voltage of VIN decreases to 1.6V or less, it is likely to become "L" regardless of Vdet voltage.</p>		RESET	Vdet < VS	L	Vdet > VS	H	
	RESET								
Vdet < VS	L								
Vdet > VS	H								

Pin No.	Pin name	Function	Internal equivalent circuit diagram						
3	Vdet	Voltage-supply pin (RESET)							
4	V <sub>IN</sub>	Voltage-supply pin							
5	V <sub>OUT1</sub>	Output pin							
6	V <sub>OUT2</sub>	Output pin							
7	GND	Ground							
8	CONT	ON/OFF Control pin <table border="1" style="margin: 10px auto;"> <tr> <td>CONT</td> <td>V<sub>OUT1</sub></td> </tr> <tr> <td>H</td> <td>ON</td> </tr> <tr> <td>L</td> <td>OFF</td> </tr> </table> <p>CONT pin must be connected with V<sub>IN</sub> pin, if it is not used.</p>	CONT	V <sub>OUT1</sub>	H	ON	L	OFF	
CONT	V <sub>OUT1</sub>								
H	ON								
L	OFF								

**Absolute Maximum Ratings** (Ta=25°C)

Item	Symbol	Ratings	Units
Storage temperature	T <sub>STG</sub>	-55~+150	°C
Output current 1	I <sub>OUT1</sub>	300	mA
Output current 2	I <sub>OUT2</sub>	300	mA
Power dissipation	P <sub>d</sub>	780 *1	mW

Note1: \*1 Attached on PC board (40 × 40 × 1.6mm).

**Recommended Operating Conditions** (Ta=25°C)

Item	Symbol	Ratings	Units
Operating temperature	T <sub>OPR</sub>	-40~+85	°C
Supply voltage	V <sub>IN</sub>	-0.3~+10	V
Output current 1	I <sub>OUT1</sub>	0~300	mA
Output current 2	I <sub>OUT2</sub>	0~300	mA
Operating voltage	V <sub>OP</sub>	0~10	V

**Electrical Characteristics** (Except where noted otherwise, Ta=25°C, VIN=5V, Io1=30mA, Io2=30mA, VCONT=1.6V)

Item	Symbol	Measurement conditions	Min.	Typ.	Max.	Units
VIN input current 1	Iccq1	IOUT1=IOUT2=0mA		1	2	mA
VIN input current 2 (VOUT1-OFF)	Iccq2	VCONT=0.4V IOUT2=0mA		0.6	1.2	mA
Vdet input current	Iccq3	Vdet=5V		20	40	μA
<b>Regulator 1 (Io1=150mA)</b>						
Output voltage 1	VO1		3.23	3.30	3.37	V
Dropout voltage 1	VIo1	VIN=3.1V, IOUT1=70mA		0.06	0.18	V
Line regulation 1	ΔV1	VIN=4.4~5.5V		1	20	mV
Load regulation 1	ΔV2	Io1=1~150mA		20	120	mV
Vo Temperature Coefficient 1 *1	ΔVO1/ΔT	Tj=-40~+85°C		100		ppm/°C
Ripple rejection 1 *1	RR1	f=1kHz Vripple=1V	50	80		dB
Output noise voltage 1 *1	Vn1	fBW=20~80kHz		100		μVrms
CONT terminal current	Ion	Vcont=1.6V		5	10	μA
CONT threshold level	VCONTH		1.6		VIN+0.3	V
CONT threshold level 1	VCONTL		-0.3		0.4	V
<b>Regulator 2 (Io2=150mA)</b>						
Output voltage 2	VO2		3.23	3.30	3.37	V
Dropout voltage 2	VIo2	VIN=3.1V, Io2=70mA		0.06	0.18	V
Line regulation 2	ΔV2	VIN=4.4~5.5V		10	20	mV
Load regulation 2	ΔV2	Io2=1~100mA		20	120	mV
Vo Temperature Coefficient 2 *1	ΔVO2/ΔT	Tj=-40~+85°C		100		ppm/°C
Ripple rejection 2 *1	RR2	f=1kHz Vripple=1V	50	80		dB
Output noise voltage 2 *1	Vn2	fBW=20~80kHz		100		μVrms
<b>Reset</b>						
Detecting voltage	Vs	Vdet=H→L	3.63	3.70	3.77	V
Vs temperature coefficient *1	ΔVs/ΔT	Tj=-40~+85°C		100		ppm/°C
Hysteresis voltage	ΔVs	Vdet=H→L→H	100		200	mV
Low-level output voltage	Vol	Vdet=3.5V RL=4.7kΩ		100	200	mV
Output leakage current	IOH	Vdet=5V RL=0kΩ			±0.1	μA
Output current 1	IOl	Vdet=3.5V RL=0kΩ	5			mA
Output current 2	IOl	Vdet=3.5V, RL=0kΩ Ta=-30~+80°C	3			mA
"H" transmission delay time *1	tPLH	Cd Terminal Open		30	90	μs
Delay time *1	tPLH1	Vdet=3.5V→5.0V Cd=0.022μF	5	10	15	ms
"L" transmission delay time *1	tPHL			30	90	μs
Threshold operating voltage	VOPL	Vol=0.4V		0.65	0.85	V

Note 1: \*1 The parameter is guaranteed by design.

Measuring Circuit

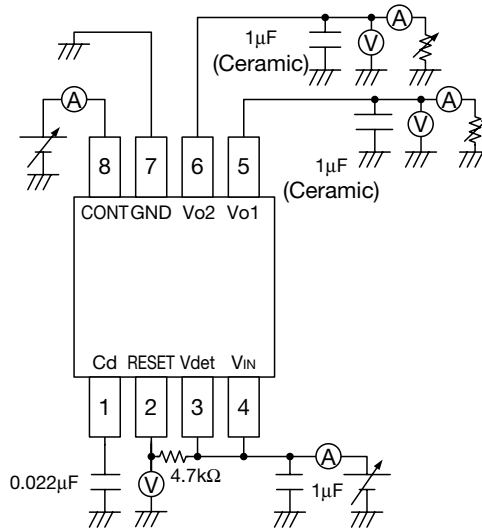

Application Circuit

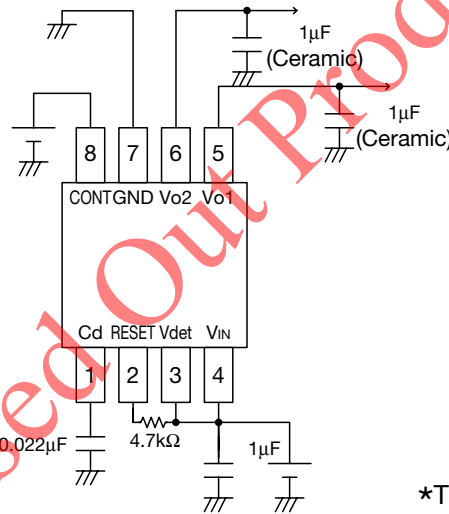

\*Temperature Characteristics: B Type

Note

1. The output capacitor is required between output and GND to prevent oscillation.
2. The output capacitor must be used in ESR stable area.  
It is possible to use a ceramic capacitor without ESR resistance for output.  
The ceramic capacitor must be used more than 1µF and B type temperature characteristics.
3. The wire of V<sub>CC</sub> and GND is required to print full ground plane for noise and stability.
4. The input capacitor must be connected in 1cm from the input pin.
5. In case the output voltage is above the input voltage, the overcurrent flows by internal parasitic diode from output to input. In such application, the external bypass diode must be connected between output and input pin.

Timing Chart

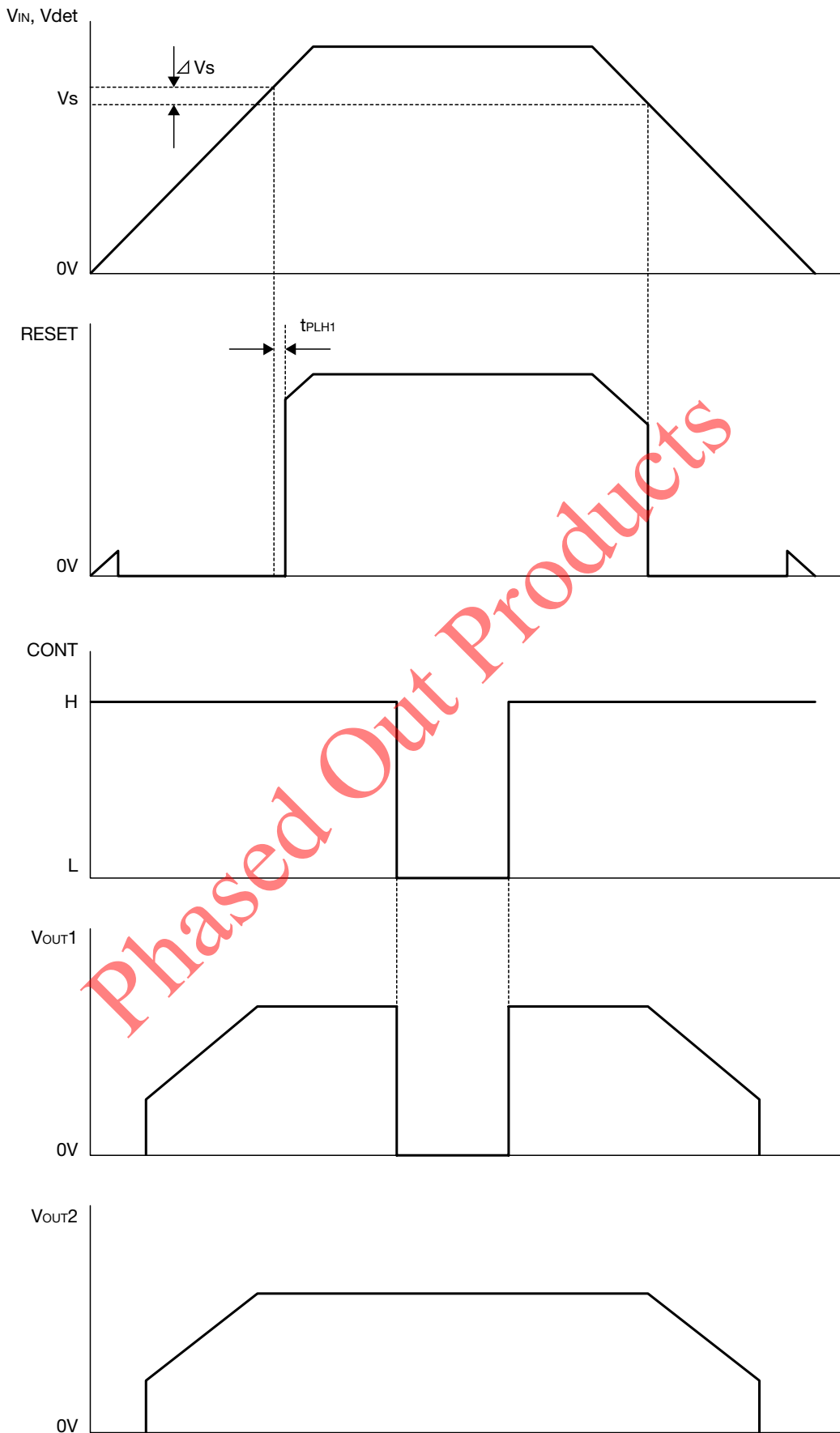

**Characteristics** (Except where noted otherwise,  $T_a=25^\circ\text{C}$ ,  $V_{IN}=V_o+1\text{V}$ ,  $V_{\text{CONT}}=1.6\text{V}$ ,  $C_{IN}=1\mu\text{F}$ ,  $C_o=1\mu\text{F}$ ,  $C_d=0.022\mu\text{F}$ )

**Output Voltage 1-Input Voltage**

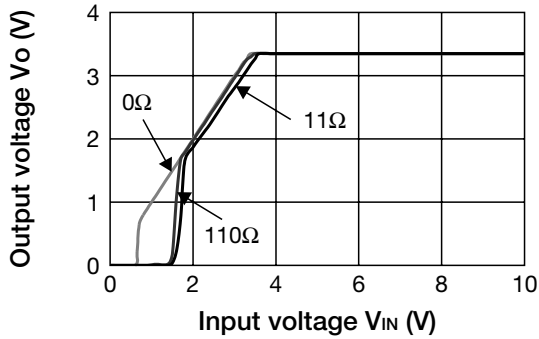

**Output Voltage 2-Input Voltage**

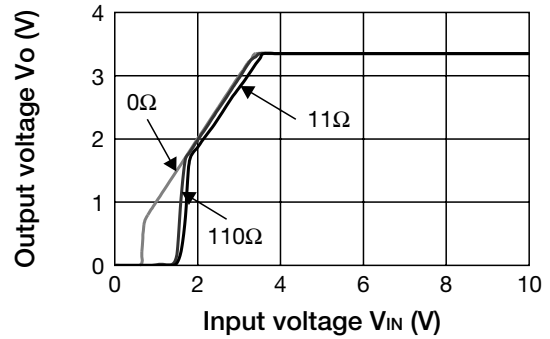

**Detecting Voltage**

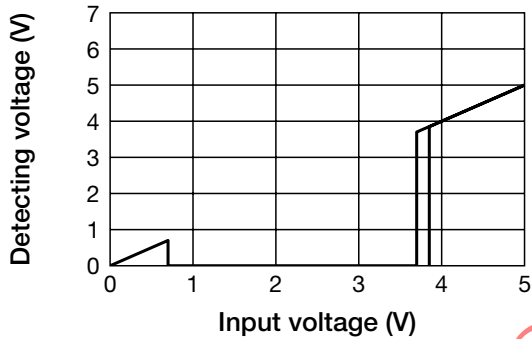

**Input current-Input Voltage**

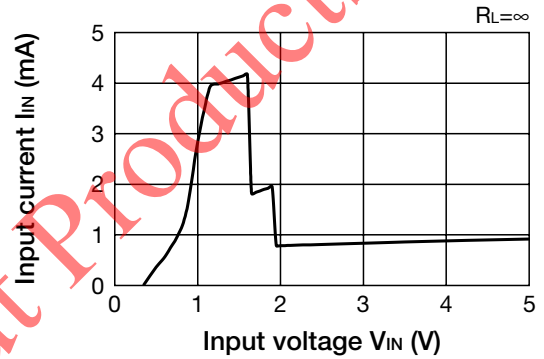

**Line Regulation Vo1**

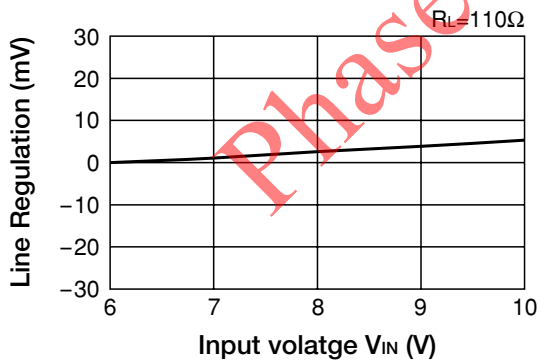

**Line Regulation Vo2**

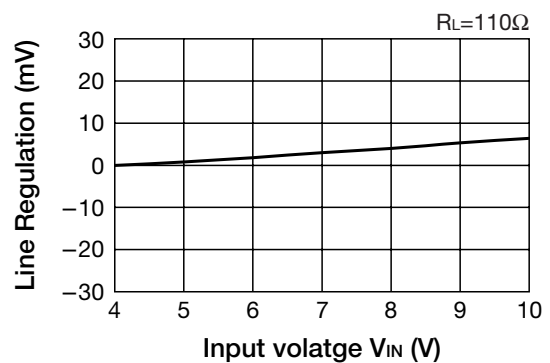

■ Load Regulation Vo1

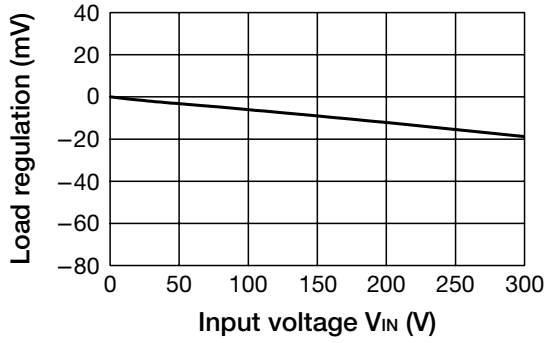

■ Load Regulation Vo2

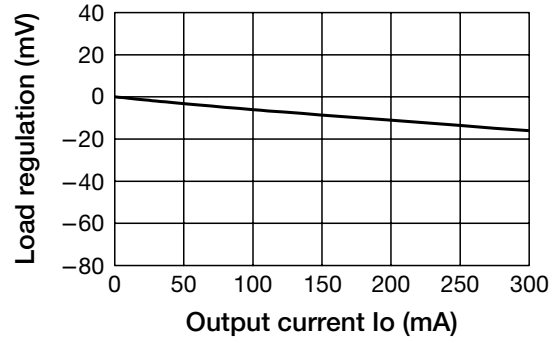

■ Dropout Voltage Vo1-Output Current

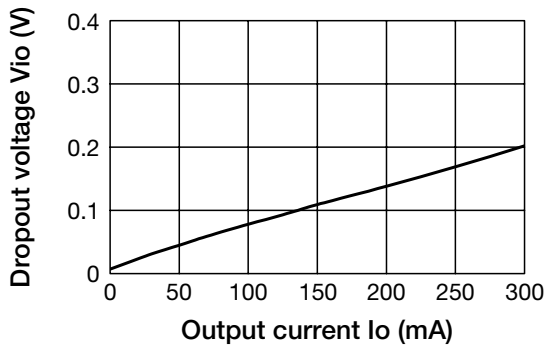

■ Dropout Voltage Vo2-Output Current

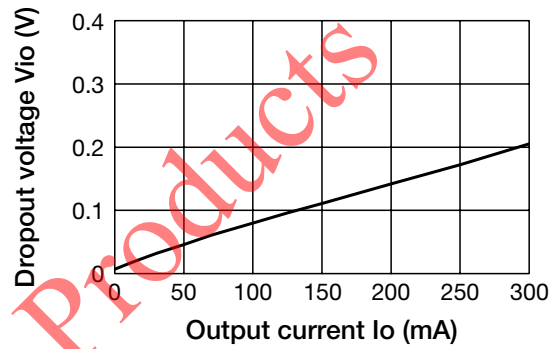

■ Current Limit Vo1

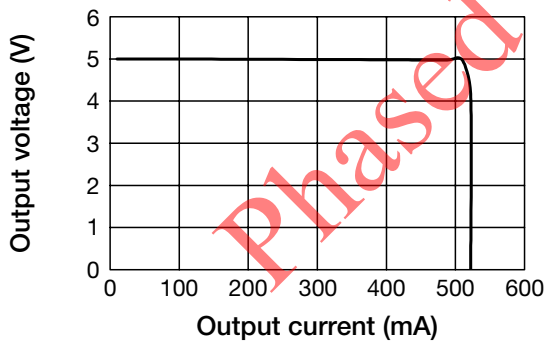

■ Current Limit Vo2

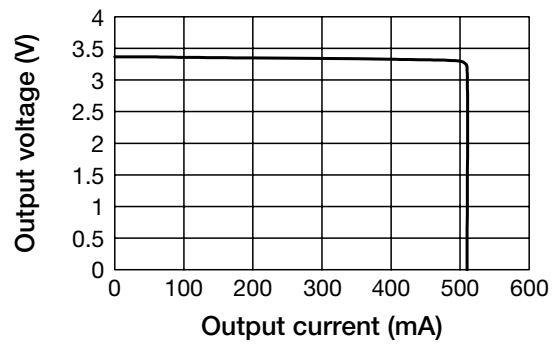



■ Output Voltage Vo1-Ambient Temperature

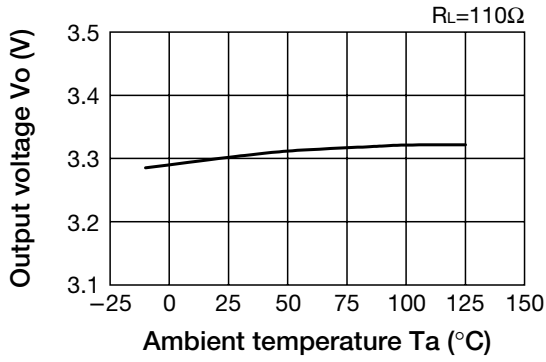

■ Output Voltage Vo2-Ambient Temperature

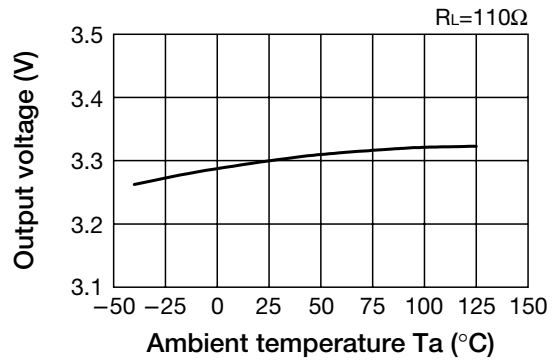

■ Detecting Voltage-Ambient Temperature

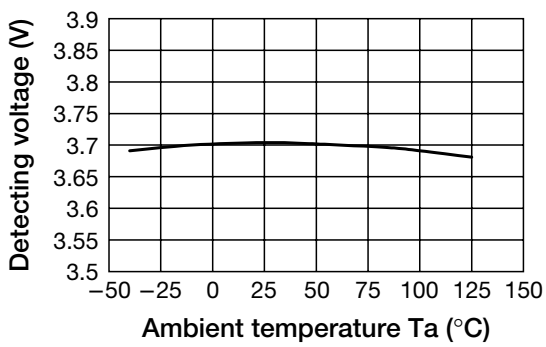

■ Ripple Rejection Vo1

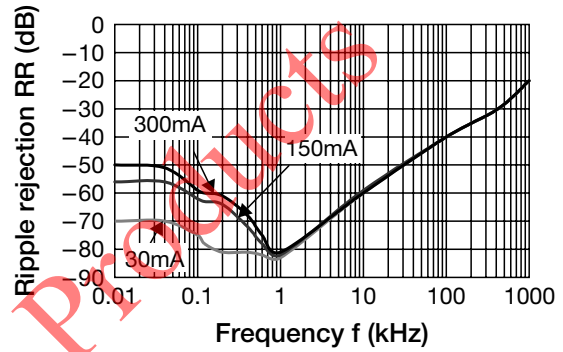

■ Ripple Rejection Vo2

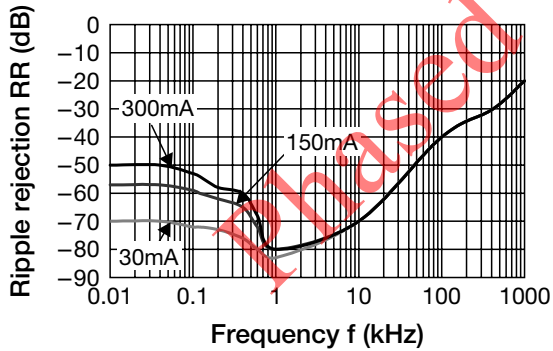

■ Load transient response Vo1 (Io=1 → 300mA)

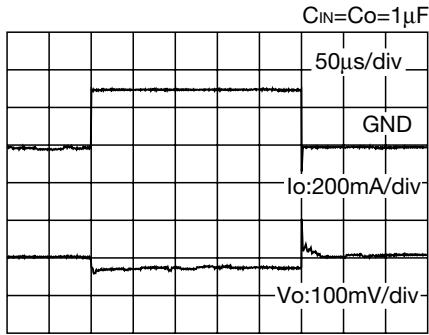

■ Load transient response Vo2 (Io=1 → 300mA)

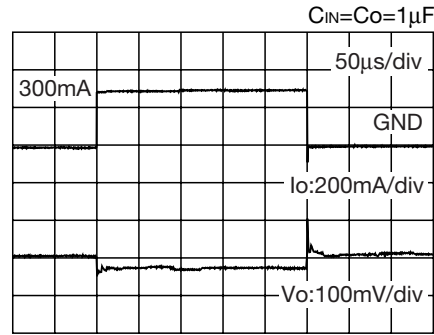

■ Turn-On Transient Responses Vo1

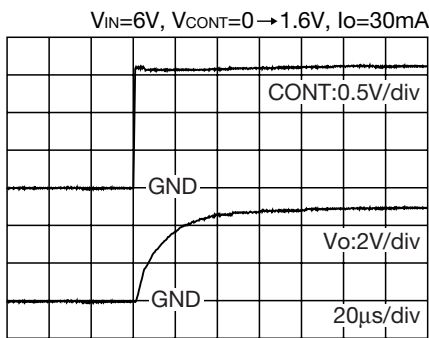

■ Turn-On Transient Responses Vo2

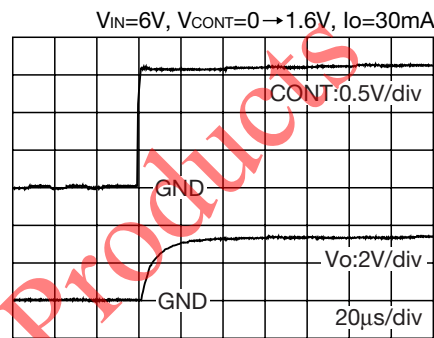

■ ESR Stable Area Vo1

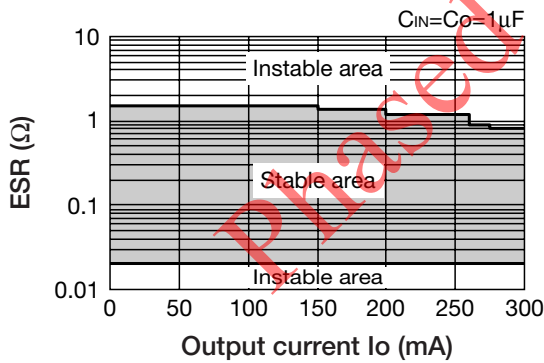

■ ESR Stable Area Vo2

