

500mA Dual Regulator Monolithic IC MM1689□ Series

Outline

This IC is a 2-circuit low saturation regulator IC with 500mA output realizing low current consumption, low noise, and high ripple rejection. The regulator output voltage is fixed and can be programmed between 1.5V and 5.0V upon request. It provides a switch pin to control each output and is an ideal IC for portable equipment.

Features

- | | |
|---|-----------------------------------|
| 1. Current consumption (during off-state) | 1μA typ. |
| 2. High accuracy output voltage | ±2.0% |
| 3. Dropout voltage | 0.2V typ. (I _o =250mA) |
| 4. High ripple rejection | 60dB typ. |
| 5. Operating temperature range | -40~+85°C |
| 6. Output voltage | 1.5 to 5.0V (0.1V steps) |
| 7. Output capacitor | 1μF (Ceramic) |

Package

HSOP-8A

Applications

1. Cordless phones
2. Portable equipment
3. DVD equipment

Pin Assignment

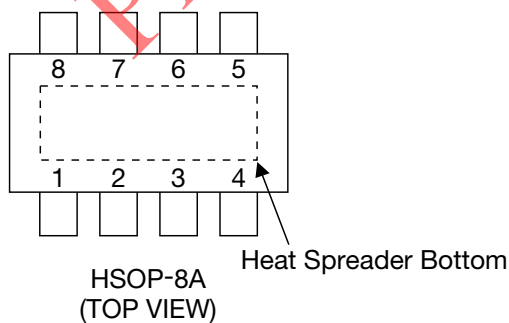

1	PS2
2	PS1
3	V _{IN2}
4	V _{IN1}
5	V _{OUT1}
6	V _{OUT2}
7	GND
8	NC

Block Diagram

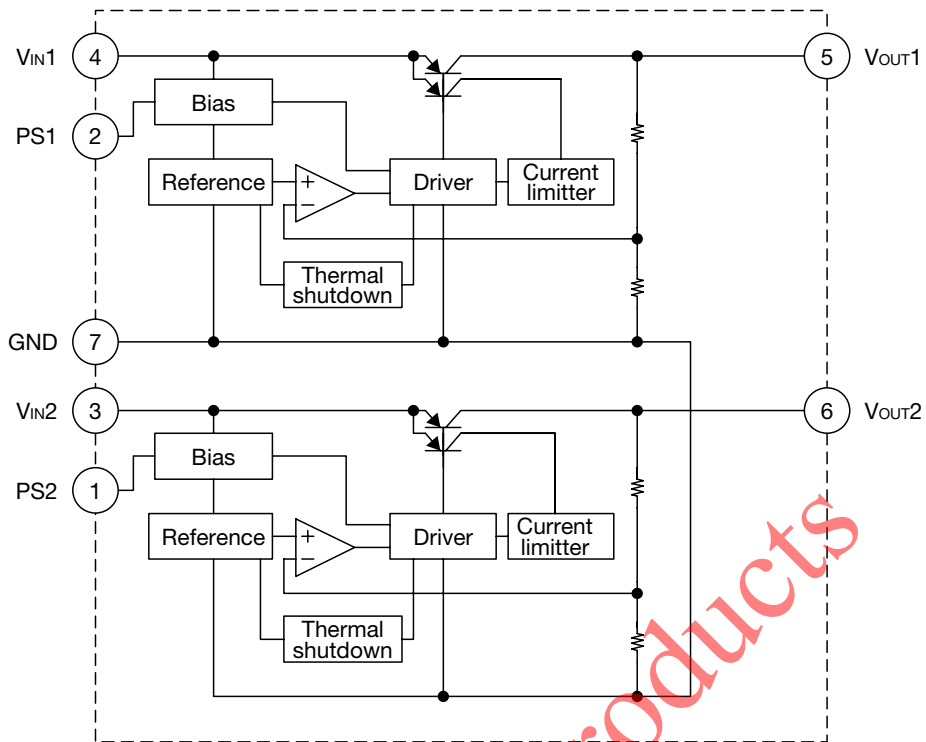

Phased Out Products

Pin Description

Pin No.	Pin name	Function	Internal equivalent circuit diagram						
1	PS2	ON/OFF Control pin <table border="1" style="margin-left: 20px;"> <tr> <td>CONT</td> <td>V_o</td> </tr> <tr> <td>H</td> <td>ON</td> </tr> <tr> <td>L</td> <td>OFF</td> </tr> </table> <p>CONT pin must be connected with V_{IN} pin, if it is not used.</p>	CONT	V _o	H	ON	L	OFF	
CONT	V _o								
H	ON								
L	OFF								
2	PS1	ON/OFF Control pin							
3	V _{IN2}	Input pin The capacitor is required to be connected with input pin more than 1μF.							
4	V _{IN1}	Input pin							
5	V _{OUT1}	Output pin The capacitor must be connected with output pin more than 1μF.							
6	V _{OUT2}	Output pin							
7	GND	Ground pin							
8	NC	No connection							

Absolute Maximum Ratings (T_a=25°C)

Item	Symbol	Ratings	Units
Storage temperature	T _{STG}	-55~+150	°C
Supply voltage	V _{IN}	-0.3~+12	V
Power dissipation	P _d	1800 (*1)	mW

Note1: *1 With the double sided PC Board of glass epoxy. (37 × 37 × 1.6mm) Copper plane 80%.

Recommended Operating Conditions (T_a=25°C)

Item	Symbol	Ratings	Units
Operating temperature	T _{OPR}	-40~+85	°C
Output current 1	I _{OUT1}	0~500	mA
Output current 2	I _{OUT2}	0~500	mA
Operating voltage	V _{OP}	0~10	V

Electrical Characteristics (Except where noted otherwise, Ta=25°C, VIN=Vo (typ.) +1V, VCONT=1.6V)

Item	Symbol	Measurement conditions	Min.	Typ.	Max.	Units
Input current (OFF)	I _{INoff}	V _{ps1} = V _{ps2} = 0V		0	1	μA
No-Load input current 1	I _{IN1}	V _{ps1} = 1.6V, V _{ps2} = 0V, I _{o1} = 0mA		0.5	1.0	mA
No-Load input current 2	I _{IN2}	V _{ps1} = 0V, V _{ps2} = 1.6V, I _{o2} = 0mA		0.5	1.0	mA
Regulator 1 (I_{o1}=500mA)						
Output voltage 1	V _{O1}	I _{o1} = 250mA	3.234	3.30	3.366	V
Dropout voltage 1	V _{io1}	V _{IN} = V _O - 0.2V, I _{o1} = 250mA		0.2	0.4	V
Line regulation 1	ΔV ₁	V _{IN} = V _O + 1.5~V _O + 2.5V, I _{o1} = 250mA		10	20	mV
Load regulation 1	ΔV ₂	I _{o1} = 0~250mA		20	120	mV
Vo temperature coefficient 1 *1	ΔV _{o1} /ΔT	T _j = -40~+85°C		100		ppm/°C
Ripple rejection 1 *1	RR ₁	f = 1kHz I _{o1} = 250mA V _{ripple} = 1V	50	60		dB
Output noise voltage 1 *1	V _{n1}	f _{BW} = 20~80kHz		100		μV _{rms}
PS pin input current 1	I _{ps1}			5	10	μA
PS pin high threshold level1	V _{PSH1}		1.6		V _{IN} +0.3	V
PS pin low threshold level 1	V _{PSL1}		-0.3		0.4	V
Regulator 2 (I_{o2}=500mA)						
Output voltage 2	V _{O2}	I _{o2} = 250mA	2.548	2.6	2.652	V
Dropout voltage 2	V _{io1}	V _{IN} = V _O - 0.2V, I _{o1} = 250mA		0.2	0.4	V
Line regulation 2	ΔV ₂	V _{IN} = V _O + 1.5~V _O + 2.5V, I _{o2} = 250mA		10	20	mV
Load regulation 2	ΔV ₂	I _{o2} = 0~250mA		20	120	mV
Vo temperature coefficient 2 *1	ΔV _{o2} /ΔT	T _j = -40~+85°C		100		ppm/°C
Ripple rejection 2 *1	RR ₂	f = 1kHz I _{o2} = 250mA V _{ripple} = 1V	50	60		dB
Output noise voltage 2 *1	V _{n2}	f _{BW} = 20~80kHz		100		μV _{rms}
PS pin input current 1	I _{ps1}			5	10	μA
PS pin high threshold level 1	V _{PSH1}		1.6		V _{IN} +0.3	V
PS pin low threshold level 1	V _{PSL1}		-0.3		0.4	V

Note 1: *1 The parameter is guaranteed by design.

Note 2: *2 The parameter is not guaranteed in the model less than V_{OUT}=2V.

Measuring Circuit

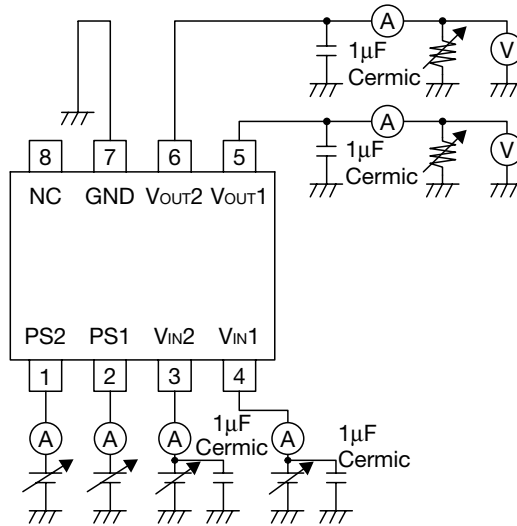

Application Circuit

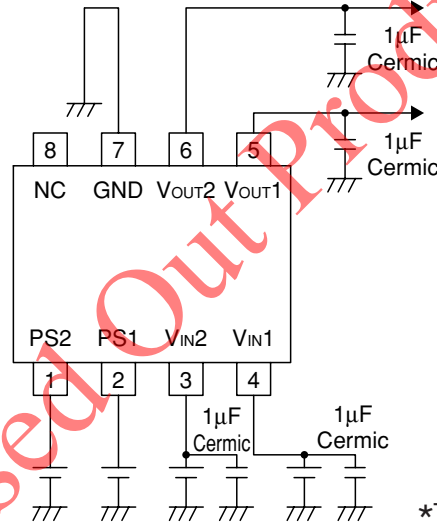

*Temperature Characteristics: B Type

NOTE

1. The output capacitor is required between output and GND to prevent the oscillation.
2. The ESR of capacitor must be defined in ESR stability area.
It is possible to use a ceramic capacitor without ESR resistance for output.
The ceramic capacitor must be used more than 1µF and B type temperature characteristics.
3. The wire of V_{CC} and GND is required to print full ground plane for noise and stability.
4. The input capacitor must be connected in 1cm from the input pin.
5. In case the output voltage is above the input voltage, the overcurrent flow by internal parasitic diode from output to input. In such application, the external bypass diode must be connected between output and input pin.

Characteristics (Vo1 Except where noted otherwise, Ta=25°C, VIN=Vo+1V, Vcont=1.6V, CIN=1μF, Co=1μF)

■ Output Voltage-Input Voltage Vo1

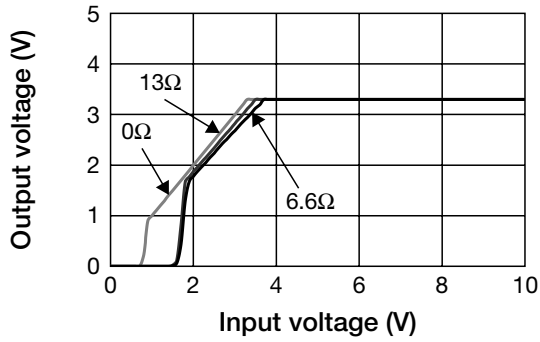

■ Input current-Input Voltage VIN1

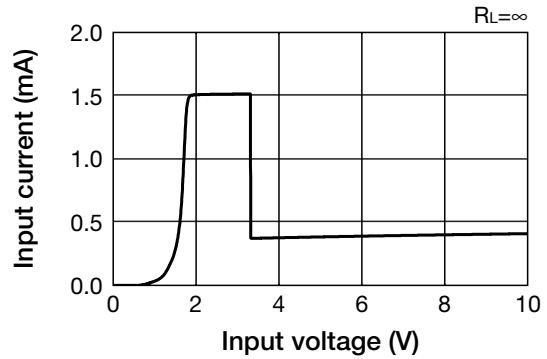

■ Load Regulation Vo1

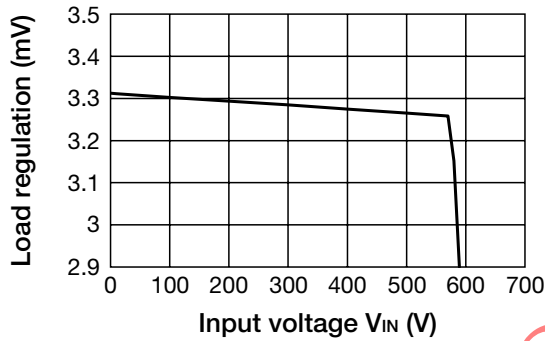

■ Line Regulation Vo1

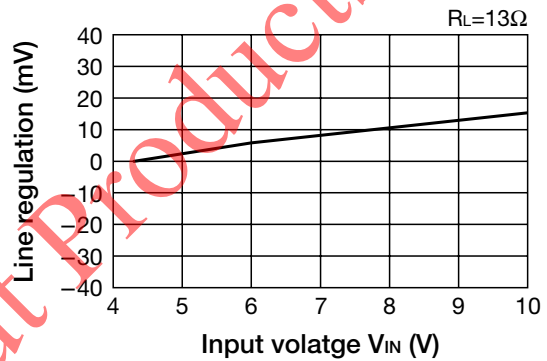

■ Dropout Voltage-Output Current Vo1

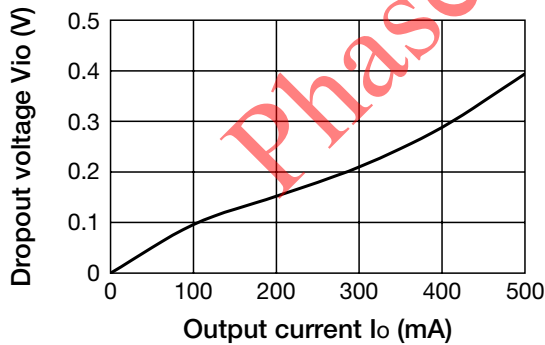

■ Output Voltage Vo1- Ambient Temperature

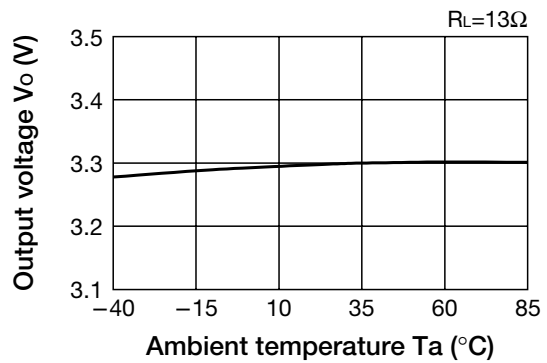

Characteristics (Vo2 Except where noted otherwise, Ta=25°C, VIN=Vo+1V, Vcont=1.6V, CIN=1μF, Co=1μF)

■ Output Voltage-Input Voltage Vo2

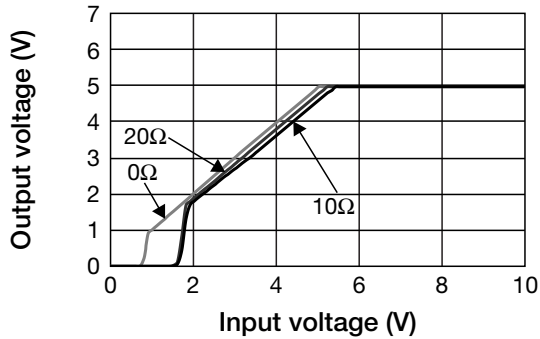

■ Input Current-Input Voltage VIN2

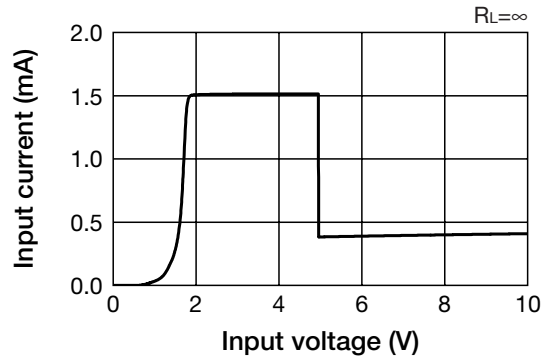

■ Load Regulation Vo2

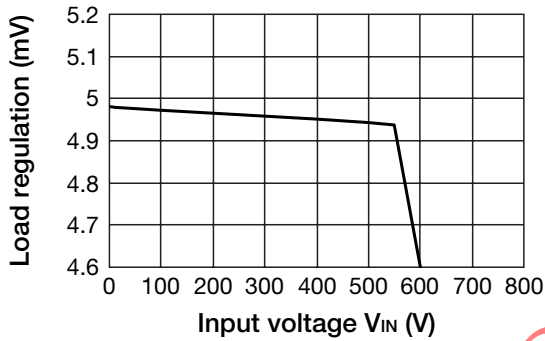

■ Line Regulation Vo2

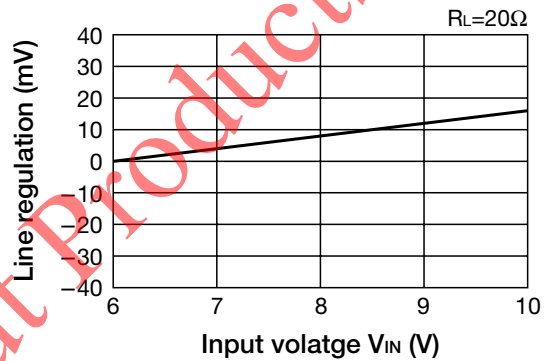

■ Dropout Voltage-Output Current Vo2

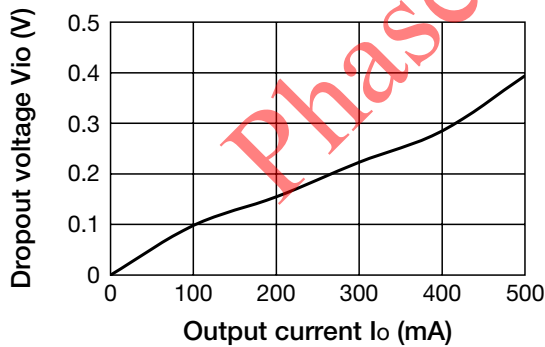

■ Output Voltage Vo2- Ambient Temperature

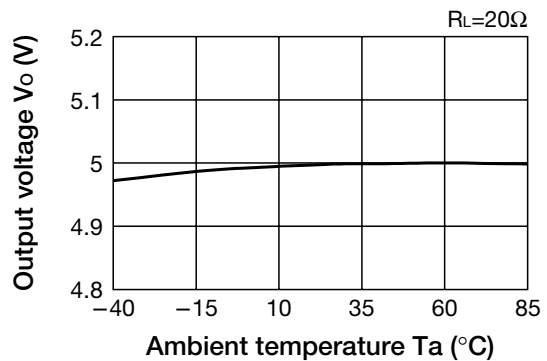

Characteristics (Except where noted otherwise, $T_a=25^\circ\text{C}$, $V_{IN}=V_O+1\text{V}$, $V_{cont}=1.6\text{V}$, $C_{IN}=1\mu\text{F}$, $C_O=1\mu\text{F}$)

Ripple Rejection Vo1

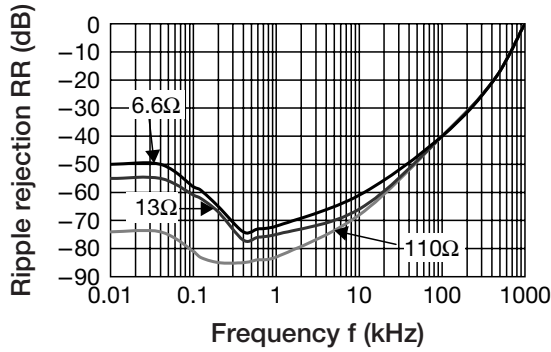

Ripple Rejection Vo2

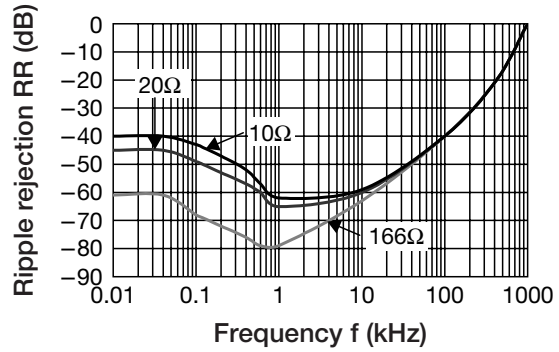

Load Transient Response Vo1 ($I_o=0 \rightarrow 500\text{mA}$)

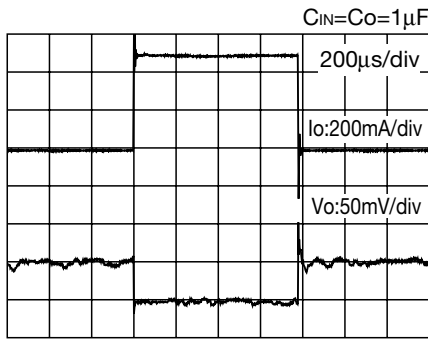

Load Transient Response Vo2 ($I_o=0 \rightarrow 500\text{mA}$)

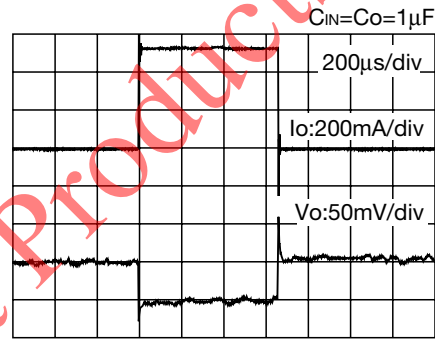

ESR Stability Area Vo1

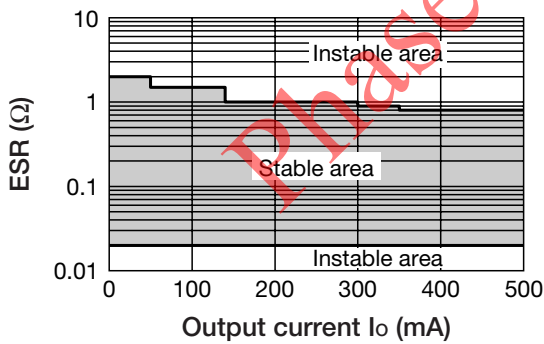

ESR Stability Area Vo2

