

IC for 150mA Regulator

Monolithic IC MM314□□N, 314□□R

Outline

This IC is an ultra-small, low noise CMOS regulator IC that supports ceramic capacitors (low ESR). Output current of up to 150mA can be obtained, and it has a high ripple rejection ratio. Also, the ON/OFF pin makes possible output ON/OFF control.

Features

- | | |
|---------------------------------------|---|
| 1. I/O voltage difference | 0.22V typ. ($I_o=150\text{mA}$, $V_{out}=3.0\text{V}$) |
| 2. Output noise voltage | 30 μVrms typ. |
| 3. Recommended maximum output current | 150mA max. |
| 4. No-load current consumption | 45 μA typ. |
| 5. High ripple rejection rate | 70dB (1kHz, $I_{out}=30\text{mA}$) |
| 6. Output voltage rank | 1.2~5.0V (0.1V steps) |
| 7. Output ON/OFF control function | High: ON, Low: OFF |

Package

SOT-25A (MM314□□N)

PLP-6A (MM314□□R)

* □□contains the output voltage rank.

Applications

1. Cordless telephone
2. Cellular telephone, PHS
3. Portable MD
4. Other battery-powered portable equipment

Pin Assignment

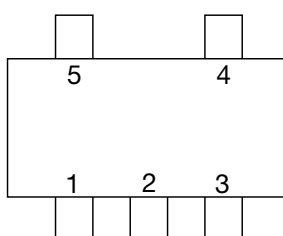

SOT-25A
(TOP VIEW)

MM314□□N

1	V_{DD}
2	GND
3	CE
4	N.C.
5	V_{OUT}

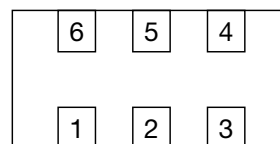

PLP-6A
(TOP VIEW)

MM314□□R

1	V_{DD}
2	N.C.
3	V_{OUT}
4	N.C.
5	GND
6	CE

*The small version of MM314□□N is MM314□□R.

Block Diagram

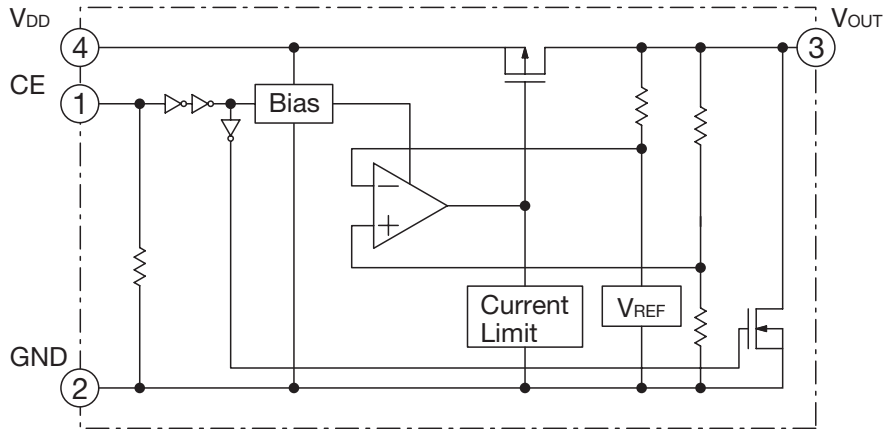

Pin Description

Pin No.		Pin name	Functions						
PLP-6A	SOT-25A								
1	1	V _{DD}	Voltage-Supply pin						
2	4	NC							
3	5	V _{OUT}	Output pin						
4		NC							
5	2	GND	GND pin						
6	3	CE	ON/OFF-Control pin						
			<table border="1"> <tr> <td>CE</td> <td>V_{OUT}</td> </tr> <tr> <td>L</td> <td>OFF</td> </tr> <tr> <td>H</td> <td>ON</td> </tr> </table>	CE	V _{OUT}	L	OFF	H	ON
			CE	V _{OUT}					
L	OFF								
H	ON								
Connect CE pin with V _{DD} pin, when it is not used.									

Absolute Maximum Ratings (Ta=25°C)

Item	Symbol	Ratings	Unit
Storage Temperature	T _{STG}	-55~+125	°C
Supply Voltage	V _{DD}	6.5	V
CE Input Voltage	V _{CE}	-0.3~V _{DD} +0.3	V
Output Voltage	V _{OUT}	-0.3~V _{DD} +0.3	V
Output Current	I _{OUT max.}	200	mA
Allowable loss	P _d	280 (PLP-6A) *1 350 (SOT-25A) *2	mW

Note 1: *1 With PC board of glass epoxy
(40×50×0.8^tmm)

Note 2: *2 With PC board of glass epoxy
(The tab pin is not connected with PC board)
(60×40×1.6^tmm)

Recommended Operating Conditions (Ta=25°C)

Item	Symbol	Ratings	Units
Operating Ambient Temperature	T _{JOP}	-40~85	°C
Operating Voltage	V _{OP}	2~6	V
Output Current	I _o	0~150	mA

Electrical Characteristics (Except where noted otherwise, V_{DD}=V_{OUT} typ.+1V, V_{CE}=V_{DD}, Ta=25°C)

Item	Symbol	Measurement conditions	Min.	Typ.	Max.	Units
Input Current (OFF)	I _{DDoff}	V _{CE} =0V		0.1	1.0	μA
No-Load Input Current	I _{DD}	I _{OUT} =0mA		45	70	μA
Output Voltage	V _{OUT}	1mA ≤ I _{OUT} ≤ 30mA	×0.98		×1.02	V
Line Regulation	V _{LINE}	V _{DD} =V _o typ. +0.5~6V, I _{OUT} =30mA (V _{OUT} ≤ 1.6V, V _{DD} =2.2~6V)		0.02	0.10	%/V
Load Regulation	V _{LOAD}	1mA ≤ I _{OUT} ≤ 150mA		22	40	mV
Dropout Voltage	V _{io}	Please refer to another page				V
Ripple Rejection 1 *1	RR1	f=1kHz, V _{RIPPLE} =0.5V, I _{OUT} =30mA (V _{OUT} ≤ 1.7V, V _{DD} =V _{OUT} +1.2V)		70		dB
Ripple Rejection 2 *1	RR2	f=10kHz, V _{RIPPLE} =0.5V, I _{OUT} =30mA (V _{OUT} ≤ 1.7V, V _{DD} =V _{OUT} +1.2V)		60		dB
V _{OUT} Temperature Coefficient *1	ΔV _{OUT} /ΔT	I _{OUT} =30mA, -40 ≤ T _{OP} ≤ 85°C		±100		ppm/°C
Output Noise Voltage *1	V _n	fbw=10~100kHz, I _{OUT} 30mA		30		μV _{rms}
Output Short-Circuit Current *1	I _{lim}	V _{OUT} =0V		40		mA
CE Pull-down Resistance	R _{pd}		0.7	2	8	MΩ
CE High Threshold Voltage	V _{CEH}		1.5		V _{DD}	V
CE Low Threshold voltage	V _{CEL}		0		0.3	V
Output NMOS ON Resistance	R _{DON}	V _{CE} =0V, V _{DD} =4V (V _{OUT} <3V)		60		Ω

Note : *1 The parameter is guaranteed by design.

Electrical Characteristics 2 (Except where noted otherwise, $V_{DD}=V_{OUT}$ typ.+1V, $V_{CE}=V_{DD}$, $T_a=25^{\circ}C$)

Model No.	PARAMETER							
	Output Voltage				Dropout Voltage			
	V_{OUT} (V)				V_{IO} (V)			
	Test Conditions	min.	typ.	max.	Test Conditions	min.	typ.	max.
MM3141C	1mA ≤ I _{OUT} ≤ 30mA	1.170	1.200	1.230	*2			
MM3141D		1.270	1.300	1.330				
MM3141E		1.370	1.400	1.430				
MM3141F		1.470	1.500	1.530	I _{OUT} =150mA		0.38	0.70
MM3141G		1.568	1.600	1.632			0.36	0.65
MM3141H		1.666	1.700	1.734			0.34	0.60
MM3141J		1.764	1.800	1.836	1.8V ≤ V _{OUT} ≤ 2.0V		0.32	0.55
MM3141K		1.862	1.900	1.938				
MM3142A		1.960	2.000	2.040				
MM3142B		2.058	2.100	2.142	2.1V ≤ V _{OUT} ≤ 2.7V		0.28	0.50
MM3142C		2.156	2.200	2.244				
MM3142D		2.254	2.300	2.346				
MM3142E		2.352	2.400	2.448				
MM3142F		2.450	2.500	2.550				
MM3142G		2.548	2.600	2.652				
MM3142H		2.646	2.700	2.754				
MM3142J		2.744	2.800	2.856				
MM3142K		2.842	2.900	2.958				
MM3143A		2.940	3.000	3.060		2.5V ≤ V _{OUT} ≤ 5.0V		0.22
MM3143B		3.038	3.100	3.162				
MM3143C		3.136	3.200	3.264				
MM3143D		3.234	3.300	3.366				
MM3143E		3.332	3.400	3.468				
MM3143F		3.430	3.500	3.570				
MM3143G		3.528	3.600	3.672				
MM3143H		3.626	3.700	3.774				
MM3143J		3.724	3.800	3.876				
MM3143K		3.822	3.900	3.978				
MM3144A		3.920	4.000	4.080				
MM3144B		4.018	4.100	4.182				
MM3144C	4.116	4.200	4.284					
MM3144D	4.214	4.300	4.386					
MM3144E	4.312	4.400	4.488					
MM3144F	4.410	4.500	4.590					
MM3144G	4.508	4.600	4.692					
MM3144H	4.606	4.700	4.794					
MM3144J	4.704	4.800	4.896					
MM3144K	4.802	4.900	4.998					
MM3145A	4.900	5.000	5.100					

Note: *2 The parameter is not guaranteed in the model less than V_{OUT}=1.4V.

Measuring Circuit

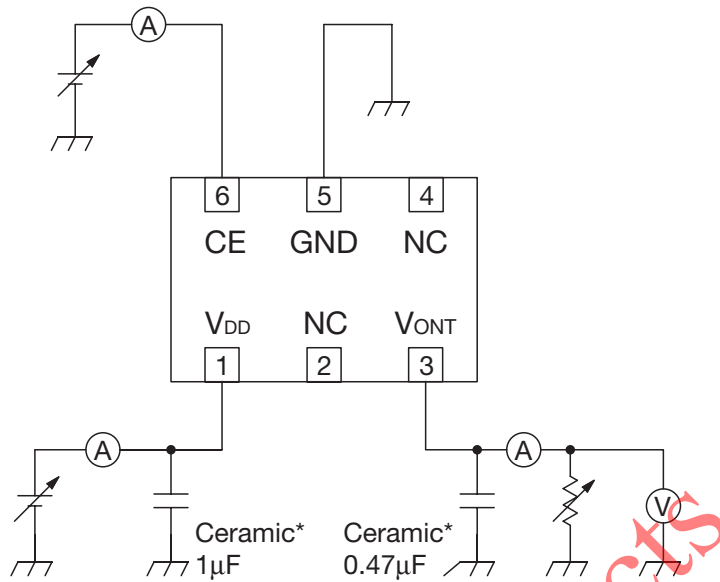

*Temperature Characteristics: B Type

Application Circuits

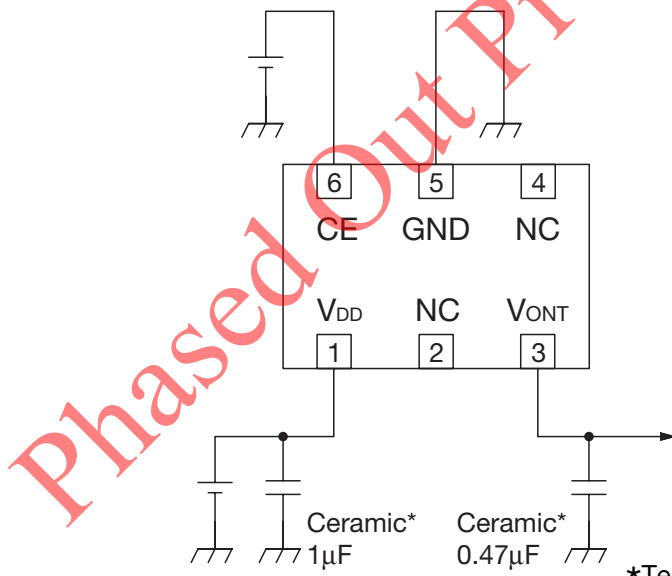

*Temperature Characteristics: B Type

(reference example of external parts)

- Output capacitor Ceramic capacitor 0.47µF
- Input capacitor Ceramic capacitor 1µF

Note

1. The output capacitor is required between output and GND to prevent oscillation.
2. Use a capacitance that is within the ESR characteristics stable range for output capacity.
It is possible to use a ceramic capacitor without ESR resistance for output.
The ceramic capacitor must be used more than 1µF and B type temperature characteristics.
3. The wire of Vcc and GND is required to print full ground plane for noise and stability.
4. The input capacitor must be connected a distance of less than 1cm from input pin.
5. In case the output voltage is above the input voltage, the overcurrent flow by internal parasitic diode from output to input.

Characteristics (2.8V product Except where noted otherwise, $V_{DD}=V_{OUT}$ typ.+1V, $V_{CE}=V_{DD}$, $T_a=25^{\circ}\text{C}$)

Output - Input Voltage

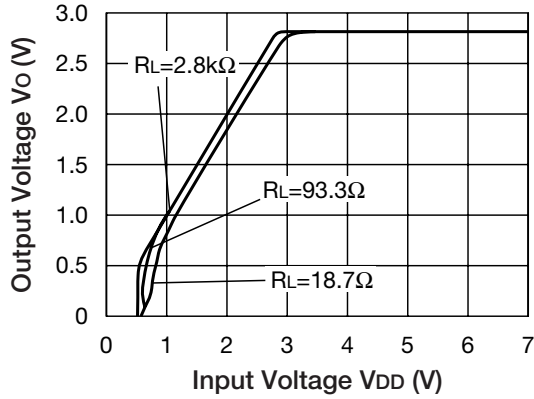

Input Current - Input Voltage

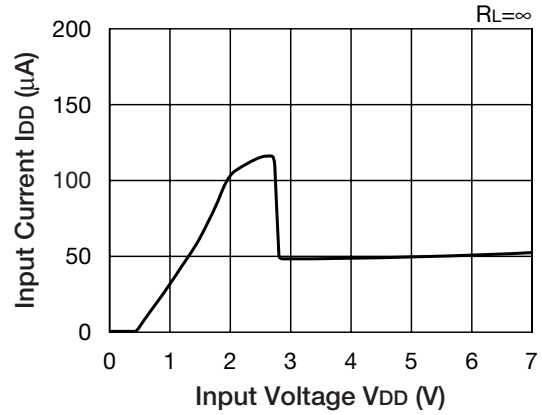

Load Regulation

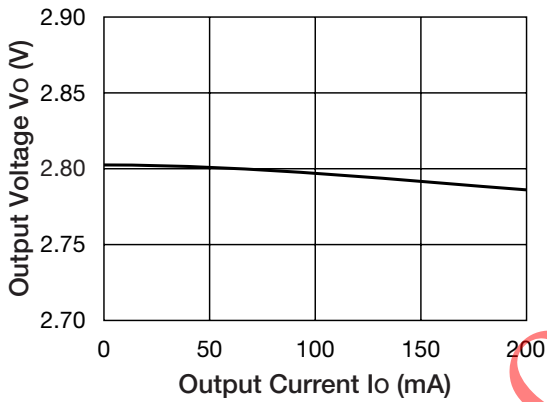

Line Regulation

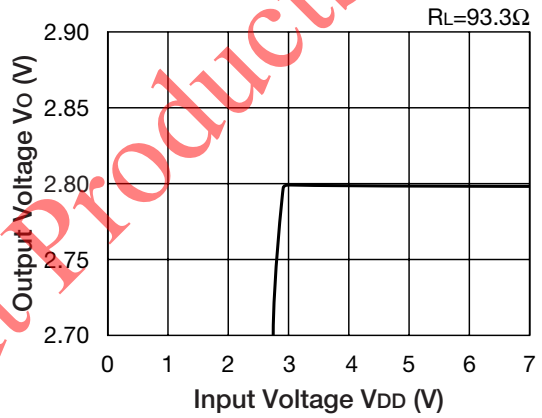

Output Voltage-Ambient Temperature

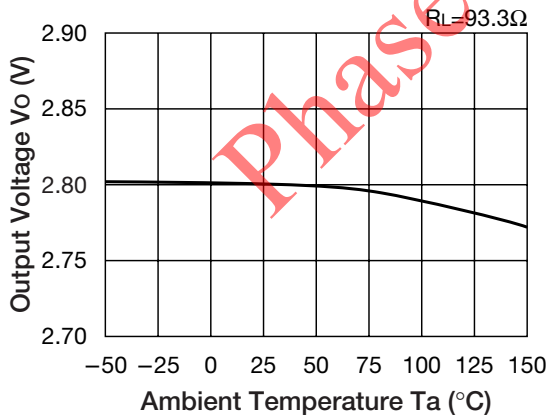

Dropout Voltage

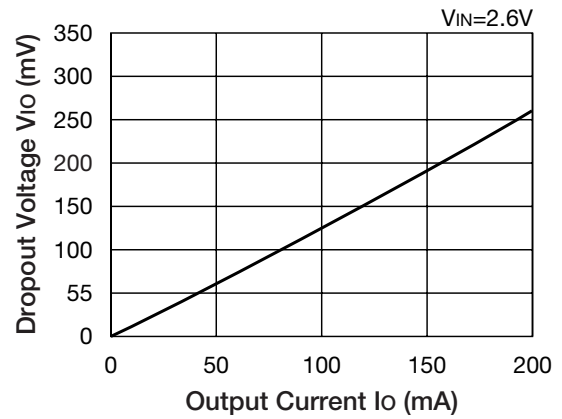

■ Output Voltage - Output Current

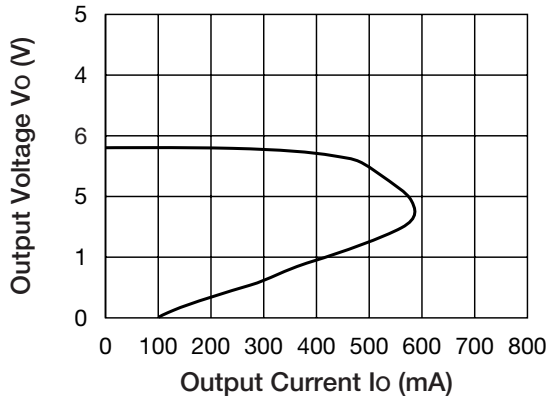

■ Ripple Rejection

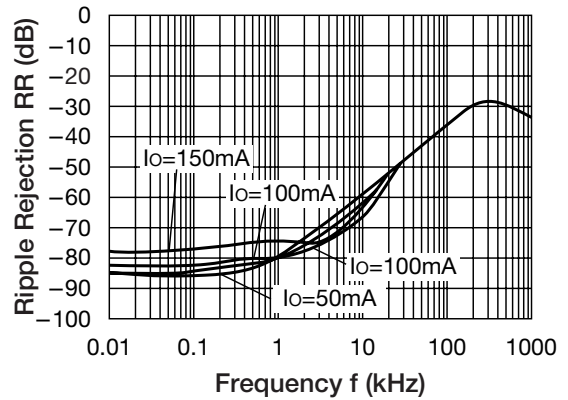

■ Load Transient Response (Io=10 → 50mA)

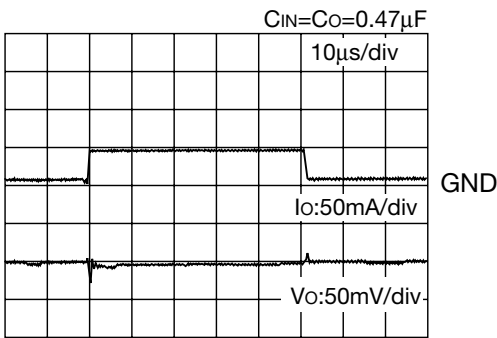

■ Load Transient Response (Io=10 → 100mA)

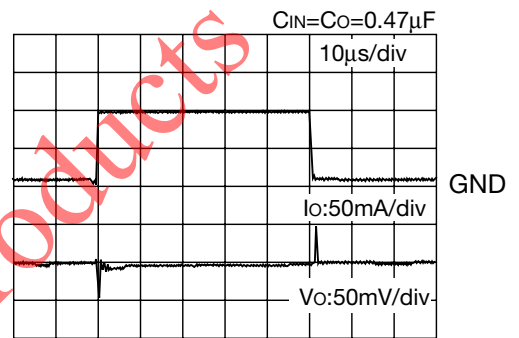

■ Load Transient Response (Io=10 → 150mA)

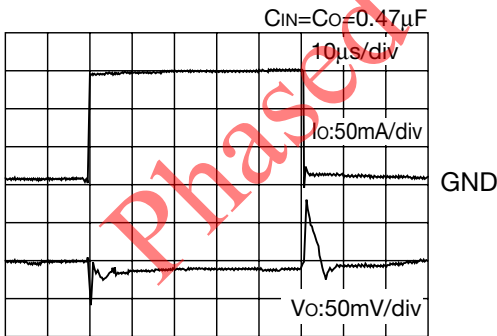

■ ESR Stability Area

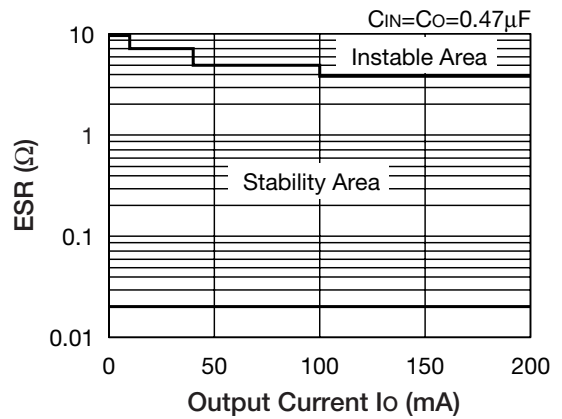

Characteristics (1.2V product Except where noted otherwise, $V_{DD}=V_{OUT}$ typ.+1V, $V_{CE}=V_{DD}$, $T_a=25^{\circ}\text{C}$)

Output Voltage - Output Current

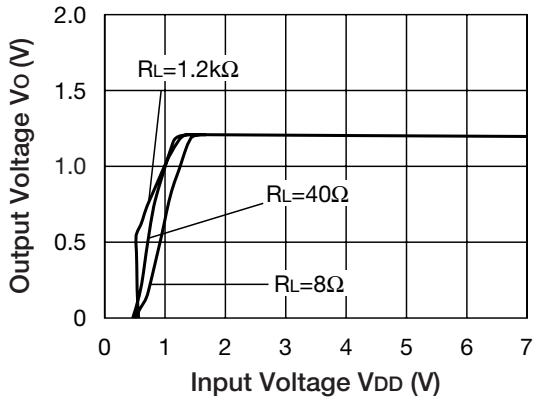

Input Current - Input Voltage

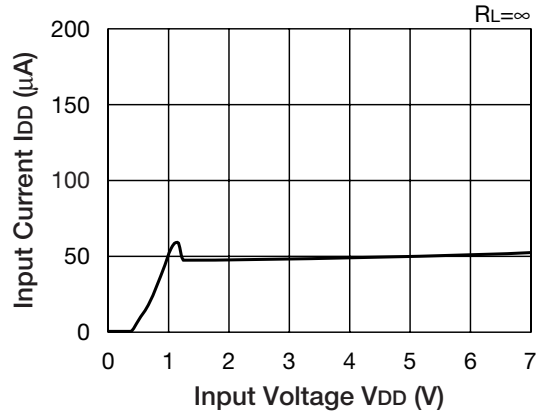

Load Regulation

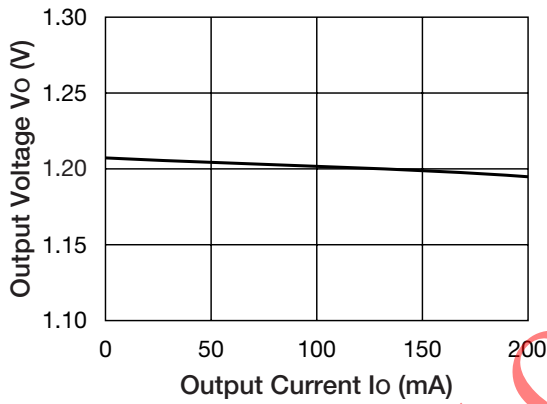

Line Regulation

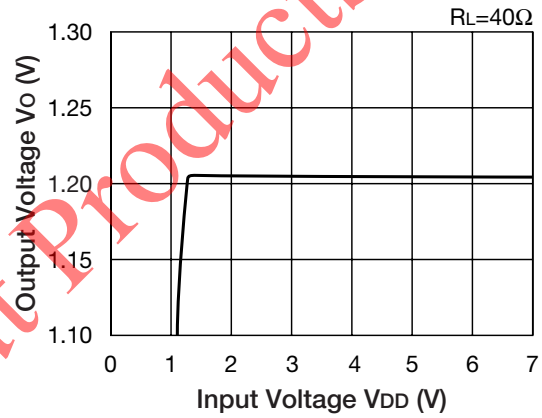

Output Voltage-Ambient Temperature

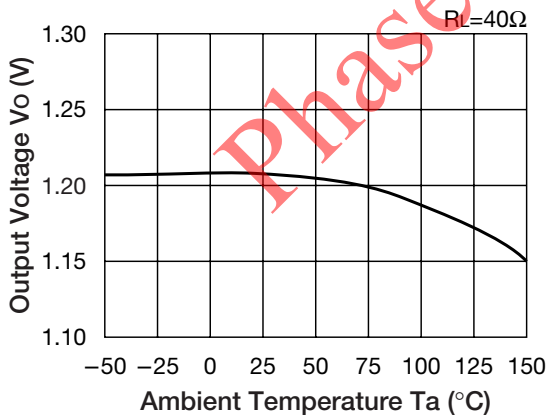

Characteristics (1.8V product Except where noted otherwise, $V_{DD}=V_{OUT}$ typ.+1V, $V_{CE}=V_{DD}$, $T_a=25^\circ\text{C}$)

■ Output - Input Voltage

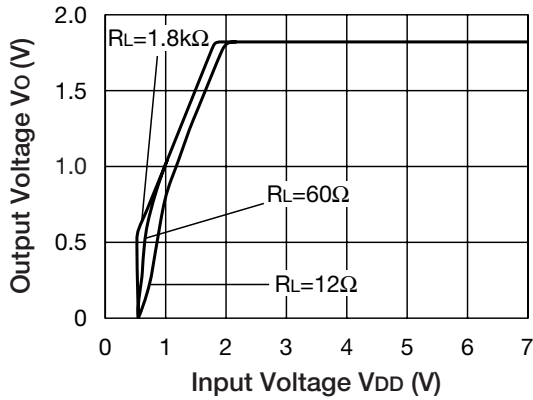

■ Input Current - Input Voltage

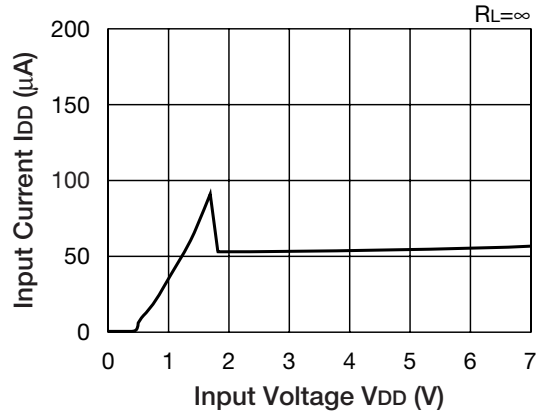

■ Load Regulation

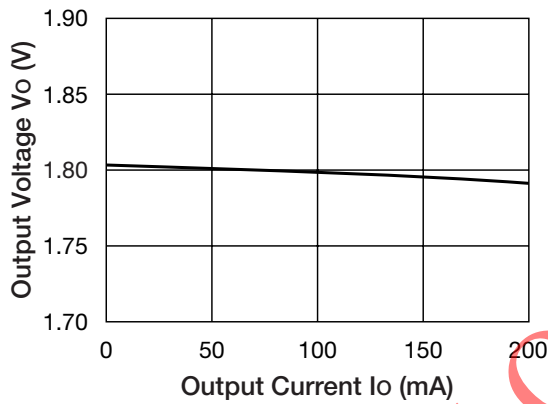

■ Line Regulation

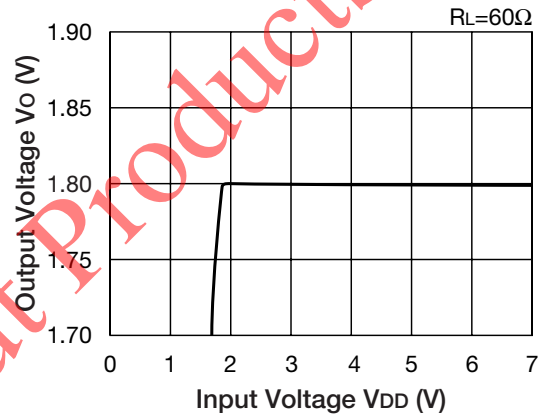

■ Output Voltage-Ambient Temperature

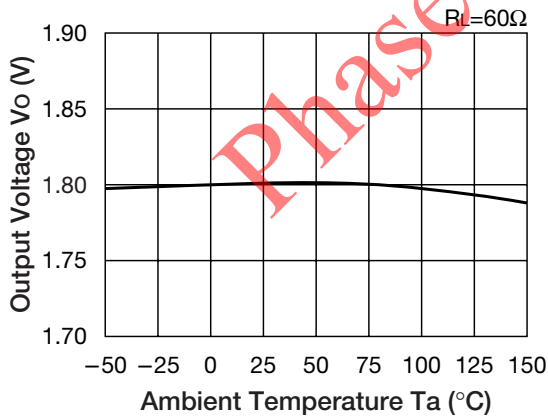

■ Dropout Voltage - Output Current

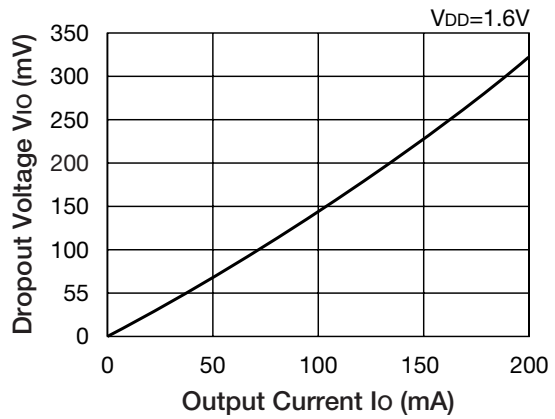

■ Output Voltage - Output Current

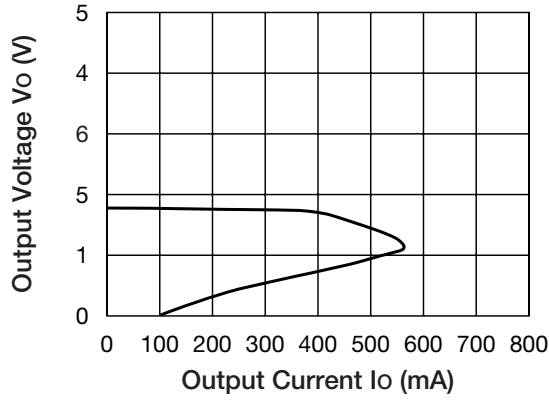

■ Ripple Rejection

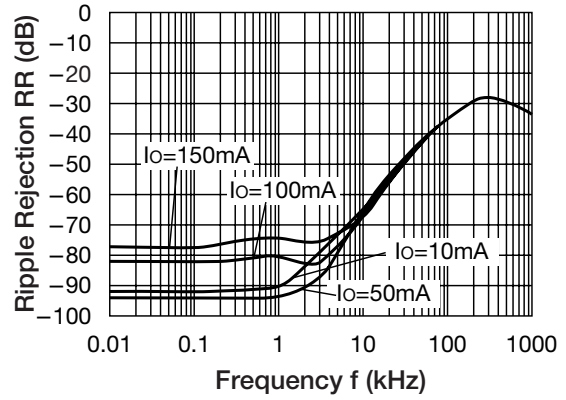

■ ESR Stability Area

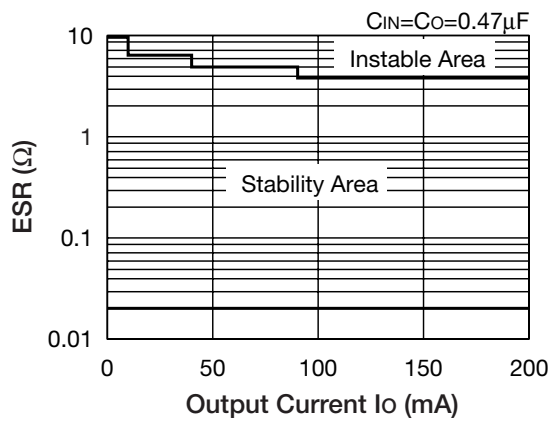

Phased Out Products

Characteristics (1.8V product Except where noted otherwise, $V_{DD}=V_{OUT}$ typ.+1V, $V_{CE}=V_{DD}$, $T_a=25^{\circ}\text{C}$)

■ Output - Input Voltage

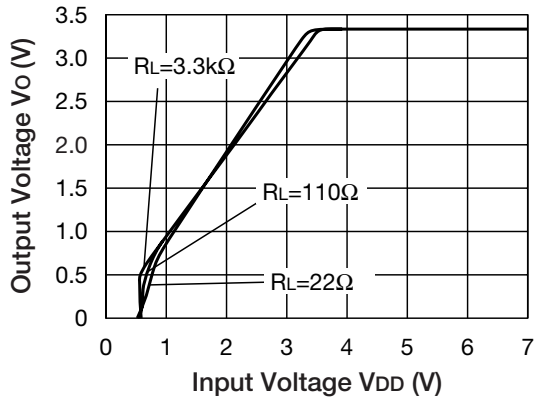

■ Input Current - Input Voltage

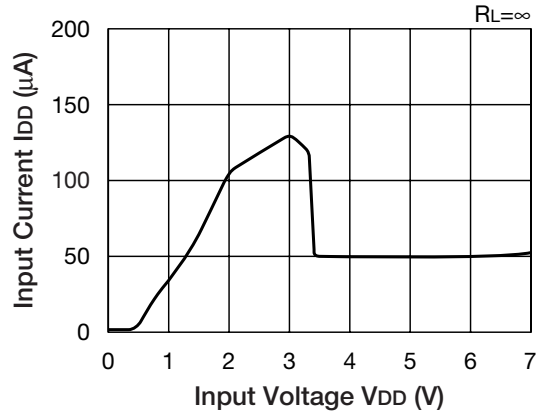

■ Load Regulation

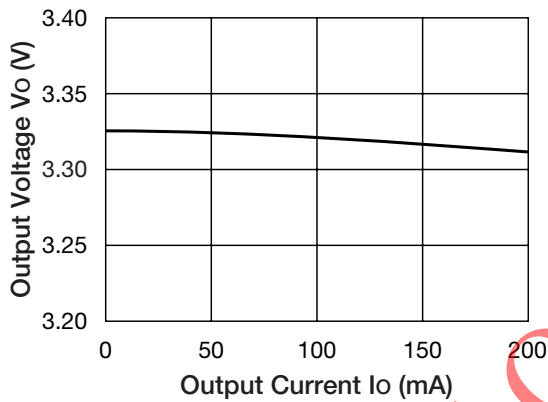

■ Line Regulation

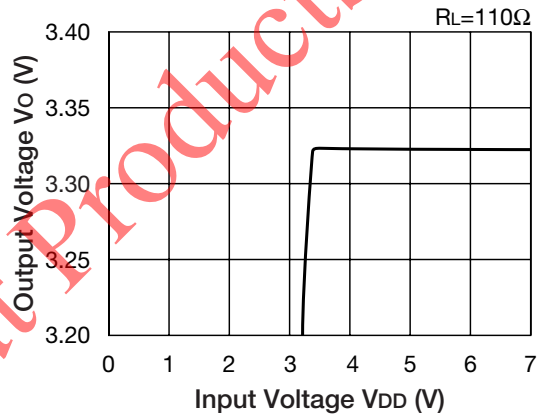

■ Output Voltage-Ambient Temperature

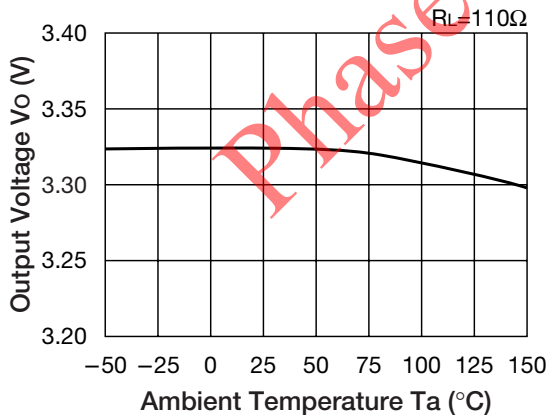

■ Dropout Voltage - Output Current

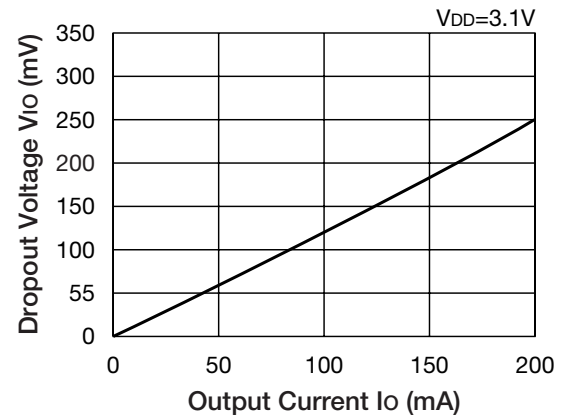

Turn-On & Turn Off Transient Response

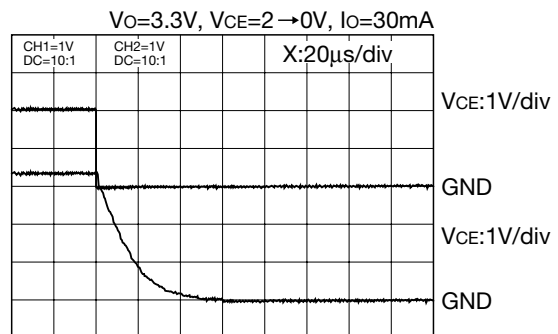
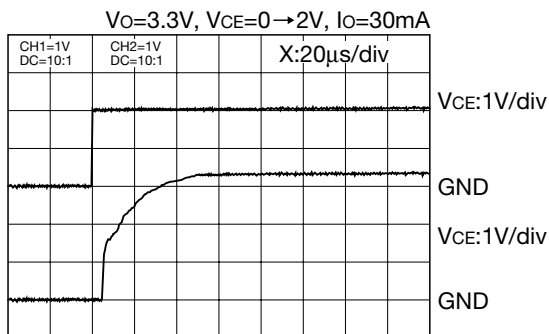
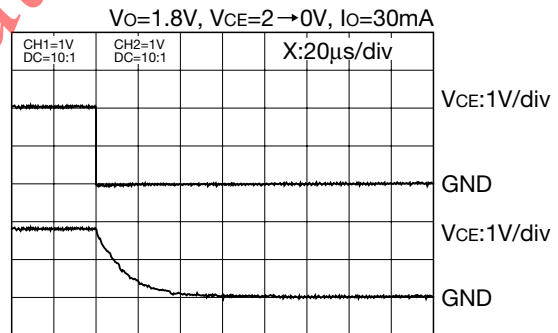
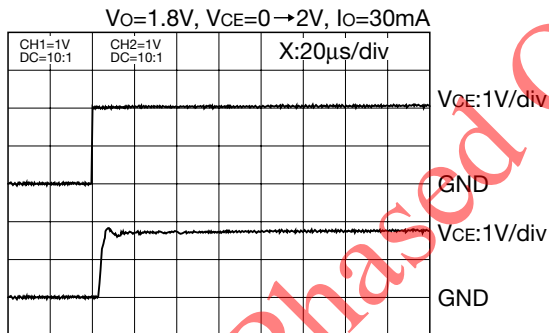
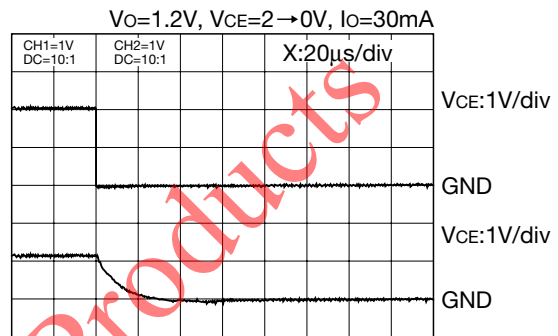
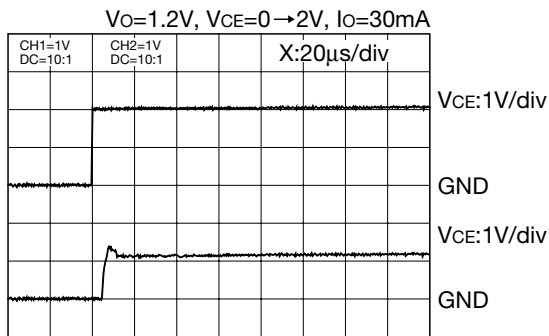
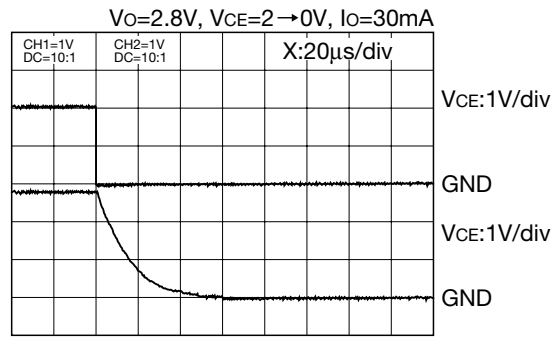
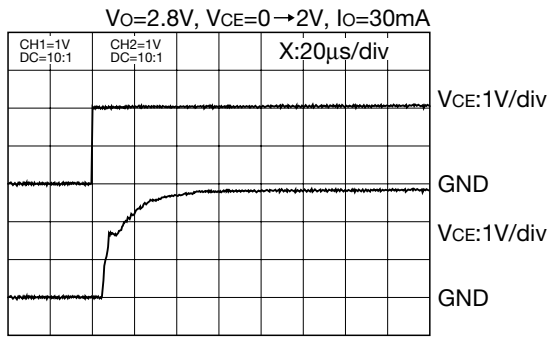

Phased Out Products