

# CMOS 300mA Regulator Monolithic IC MM329□□ Series

## Outline

This IC is a low saturation regulator IC with 300mA output realizing low current consumption (45μA), low noise, and high ripple rejection using a CMOS process. The output capacitor is a ceramic capacitor, and the IC provides an ON/OFF control pin.

## Features

- |                                 |                                    |
|---------------------------------|------------------------------------|
| 1. Low current consumption      | 45μA                               |
| 2. High accuracy output voltage | ±2.0%                              |
| 3. Dropout voltage              | 0.22V typ. (I <sub>o</sub> =150mA) |
| 4. High ripple rejection        | 70dB typ.                          |
| 5. Operating temperature range  | -40 to +85°C                       |
| 6. Output voltage               | 1.5 to 5.0V (0.1V steps)           |
| 7. Output capacitor             | 0.47μF (Ceramic)                   |

## Package

1. SOT-25A
2. PLP-6A

## Applications

1. Constant voltage power supplies for battery-powered devices
2. Constant voltage sources for portable communication equipment
3. Constant voltage sources for home appliances

Phased Out Products

Pin Assignment

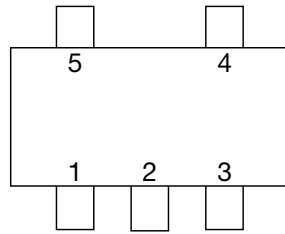

SOT-25A  
(TOP VIEW)

1	V <sub>DD</sub>
2	GND
3	CE
4	NC
5	V <sub>OUT</sub>

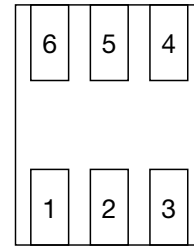

PLP-6A  
(TOP VIEW)

1	V <sub>DD</sub>
2	NC
3	V <sub>OUT</sub>
4	NC
5	GND
6	CE

Phased Out Products

Block Diagram

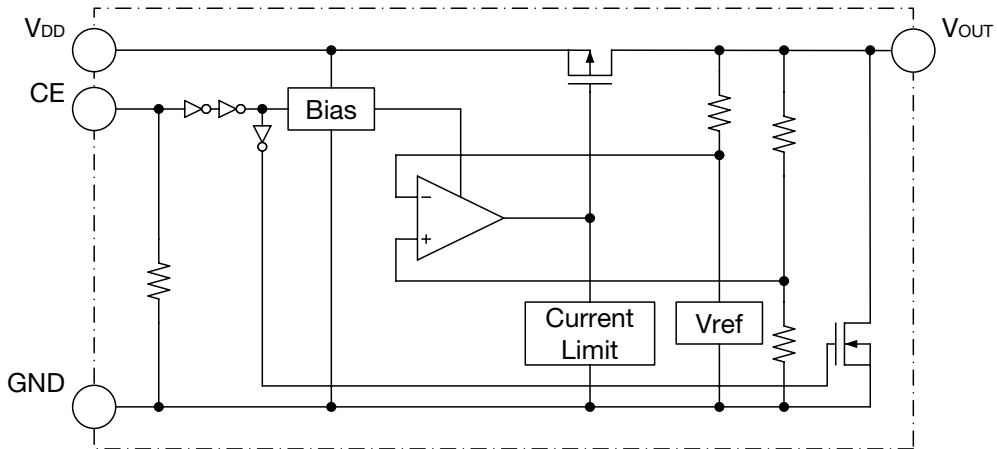

Pin Description

Pin No.		Pin name	Function						
SOT-25A	PLP-6A								
1	1	V <sub>DD</sub>	Voltage-supply pin						
4	2, 4	NC	No connection						
5	3	V <sub>OUT</sub>	Output pin						
2	5	GND	Ground						
3	6	CE	ON/OFF-Control pin						
			<table border="1"> <tr> <td>CE</td> <td>V<sub>OUT</sub></td> </tr> <tr> <td>L</td> <td>OFF</td> </tr> <tr> <td>H</td> <td>ON</td> </tr> </table>	CE	V <sub>OUT</sub>	L	OFF	H	ON
CE	V <sub>OUT</sub>								
L	OFF								
H	ON								
			Connect CE pin with V <sub>DD</sub> pin, when it is not used.						

Absolute Maximum Ratings (Ta=25°C)

Item	Symbol	Ratings		Units
Storage temperature	T <sub>STG</sub>	-55~+150		°C
Supply voltage	V <sub>DD</sub>	7.0		V
CE input voltage	V <sub>CE</sub>	-0.3~V <sub>DD</sub> +0.3		V
Output voltage	V <sub>OUT</sub>	-0.3~V <sub>DD</sub> +0.3		V
Output current	I <sub>omax</sub>	350		mA
Power dissipation	Pd	SOT-25A	350mW *1	mW
		PLP-6A	280mW *2	

Note1: \*1 With PC Board of glass epoxy 60×40×1.6mm

Note2: \*2 With PC Board of glass epoxy 40×50×0.8mm

**Recommended Operating Conditions** (Ta=25°C)

Item	Symbol	Ratings	Units
Operating ambient temperature	T <sub>JOP</sub>	-40~+85	°C
Operating voltage	V <sub>OP</sub>	2~6	V
Output current	I <sub>O</sub>	0~300	mA

**Electrical Characteristics 1** (Except where noted otherwise, Ta=25°C, V<sub>DD</sub>=V<sub>OUT</sub> (typ.) +1V, V<sub>CE</sub>=V<sub>DD</sub>)

Item	Symbol	Measurement conditions	Min.	Typ.	Max.	Units
Input current (OFF)	I <sub>DDoff</sub>	V <sub>CE</sub> =0V		0.1	1.0	μA
No-Load input current	I <sub>DD</sub>	I <sub>OUT</sub> =0mA		45	70	μA
Output voltage	V <sub>OUT</sub>	1mA ≤ I <sub>OUT</sub> ≤ 30mA	×0.98		×1.02	V
Line regulation	V <sub>LINE</sub>	V <sub>DD</sub> =V <sub>O</sub> (Typ.) +0.5~6V, I <sub>OUT</sub> =30mA (V <sub>OUT</sub> ≤ 1.6V, V <sub>DD</sub> =2.2~6V)		0.02	0.10	%/V
Load regulation	V <sub>LOAD</sub>	1mA ≤ I <sub>OUT</sub> ≤ 300mA		50	120	mV
Dropout voltage	V <sub>IO</sub>	Please refer to Electrical Characteristics 2				V
Ripple rejection 1 *1	RR1	f=1kHz, V <sub>ripple</sub> =0.5V, I <sub>OUT</sub> =30mA (V <sub>OUT</sub> ≤ 1.7V, V <sub>DD</sub> =V <sub>OUT</sub> +1.2V)		70		dB
Ripple rejection 2 *1	RR2	f=10kHz, V <sub>ripple</sub> =0.5V, I <sub>OUT</sub> =30mA (V <sub>OUT</sub> ≤ 1.7V, V <sub>DD</sub> =V <sub>OUT</sub> +1.2V)		60		dB
V <sub>OUT</sub> temperature coefficient *1	ΔV <sub>OUT</sub> /ΔT	I <sub>OUT</sub> =30mA -40 ≤ T <sub>OP</sub> ≤ 85°C		±100		ppm/°C
Output Noise voltage *1	V <sub>n</sub>	FBW=10~100kHz I <sub>OUT</sub> =30mA		30		μV <sub>rms</sub>
Output short-circuit current *1	I <sub>lim</sub>	V <sub>OUT</sub> =0V		40		mA
CE Pull-down resistance	R <sub>pd</sub>		0.7	2	8	MΩ
CE high Threshold voltage	V <sub>CEH</sub>		1.5		V <sub>DD</sub>	V
CE low Threshold voltage	V <sub>CEL</sub>		0		0.3	V
Output NMOS ON resistance	R <sub>DON</sub>	V <sub>CE</sub> =0V V <sub>DD</sub> =4V (V <sub>OUT</sub> <3V)		60		Ω

Note1: \*1 The parameter is guaranteed by design.

**Electrical Characteristics 2** (Except where noted otherwise, Ta=25°C, VDD=VOUT (typ.)+1V, VCE=VDD)

Model No.	Item							
	Output voltage				Dropout voltage			
	V <sub>OUT</sub> (V)				V <sub>IO</sub> (V)			
	Measurement conditions	Min.	Typ.	Max.	Measurement conditions	Min.	Typ.	Max.
MM3291C	1mA ≤ I <sub>OUT</sub> ≤ 30mA	1.170	1.200	1.230	*			
MM3291D		1.270	1.300	1.330				
MM3291E		1.370	1.400	1.430				
MM3291F		1.470	1.500	1.530	I <sub>OUT</sub> =150mA		0.38	0.70
MM3291G		1.568	1.600	1.632			0.36	0.65
MM3291H		1.666	1.700	1.734			0.34	0.60
MM3141J		1.764	1.800	1.836	1.8V ≤ V <sub>OUT</sub> ≤ 2.0V		0.32	0.55
MM3291K		1.862	1.900	1.938				
MM3292A		1.960	2.000	2.040				
MM3292B		2.058	2.100	2.142	2.1V ≤ V <sub>OUT</sub> ≤ 2.7V		0.28	0.50
MM3292C		2.156	2.200	2.244				
MM3292D		2.254	2.300	2.346				
MM3292E		2.352	2.400	2.448				
MM3292F		2.450	2.500	2.550				
MM3292G		2.548	2.600	2.652				
MM3292H		2.646	2.700	2.754				
MM3292J		2.744	2.800	2.856				
MM3292K		2.842	2.900	2.958				
MM3293A		2.940	3.000	3.060		2.5V ≤ V <sub>OUT</sub> ≤ 5.0V		
MM3293B		3.038	3.100	3.162				
MM3293C	3.136	3.200	3.264					
MM3293D	3.234	3.300	3.366					
MM3293E	3.332	3.400	3.468					
MM3293F	3.430	3.500	3.570					
MM3293G	3.528	3.600	3.672					
MM3293H	3.626	3.700	3.774					
MM3293J	3.724	3.800	3.876					
MM3293K	3.822	3.900	3.978					
MM3294A	3.920	4.000	4.080					
MM3294B	4.018	4.100	4.182					
MM3294C	4.116	4.200	4.284					
MM3294D	4.214	4.300	4.386					
MM3294E	4.312	4.400	4.488					
MM3294F	4.410	4.500	4.590					
MM3294G	4.508	4.600	4.692					
MM3294H	4.606	4.700	4.794					
MM3294J	4.704	4.800	4.896					
MM3294K	4.802	4.900	4.998					
MM3295A	4.900	5.000	5.100					

Note1: \* The parameter is not guaranteed in the model less than V<sub>OUT</sub>=1.4V.

Measuring Circuit

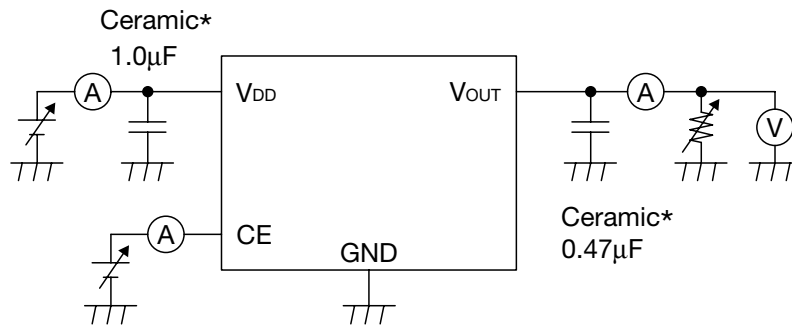

Application Circuit

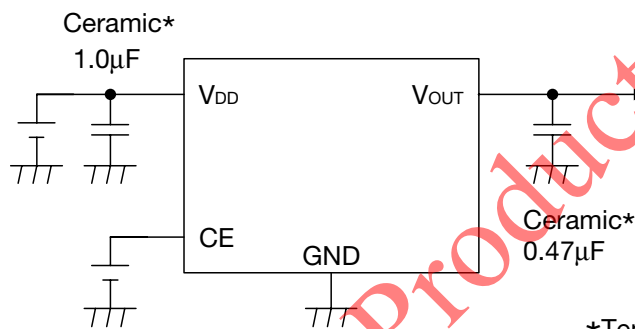

\*Temperature Characteristics : B

Note

1. The output capacitor is required between output and GND to prevent oscillation.
2. The output capacitor must be used in ESR stable area.  
It is possible to use a ceramic capacitor without ESR resistance for output.  
The ceramic capacitor must be used more than 1.0µF or 0.47µF and B temperature characteristics.
3. The wire of V<sub>CC</sub> and GND is required to print full ground plane for noise and stability.
4. The input capacitor must be connected in 1cm from the input pin.
5. In case the output voltage is above the input voltage, the overcurrent flows by internal parasitic diode from output to input.

**Characteristics** ( $V_o=3.0V$  Except where noted otherwise,  $T_a=25^\circ C$ ,  $V_{DD}=V_{OUT} (typ.) +1V$ ,  $V_{CE}=V_{DD}$ )

**Output-Input Voltage**

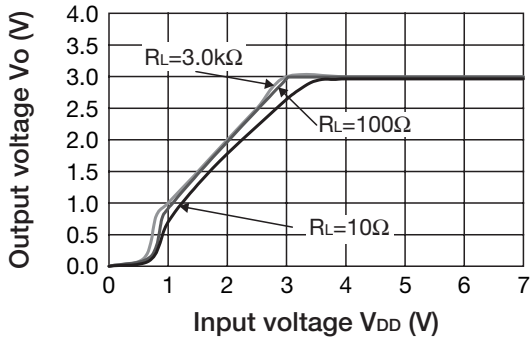

**Input Current-Input Voltage**

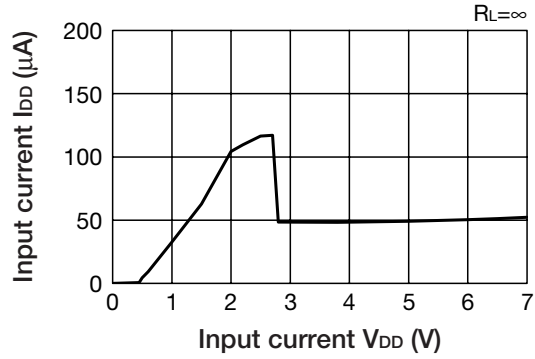

**Load regulation**

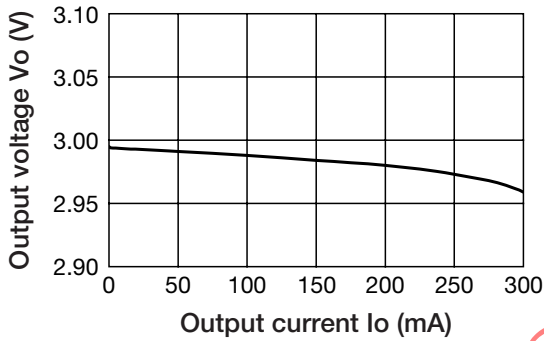

**Line Regulation**

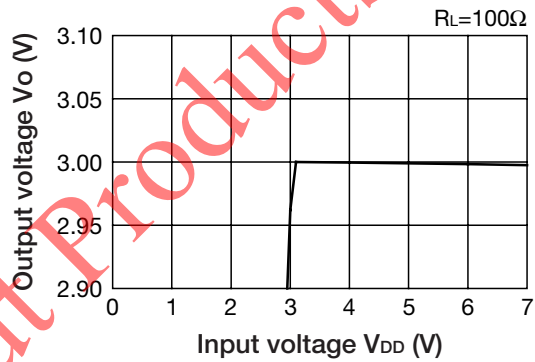

**Output Voltage-Ambient Temperature**

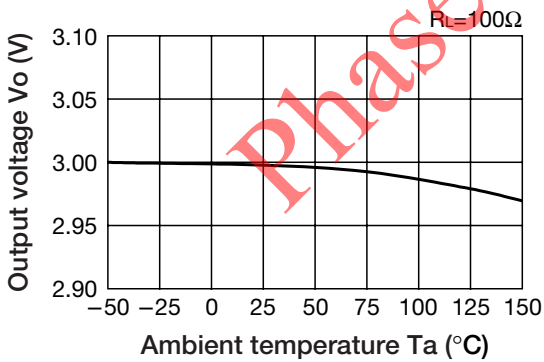

**Dropout Voltage**

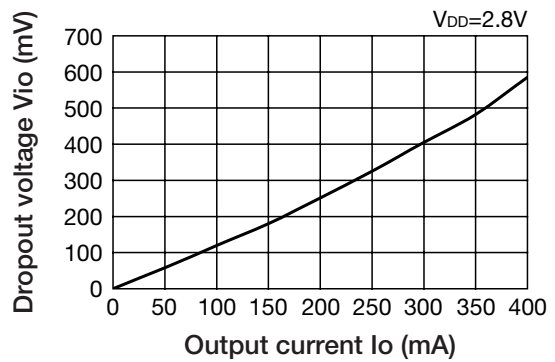

■ Output Voltage-Output Current

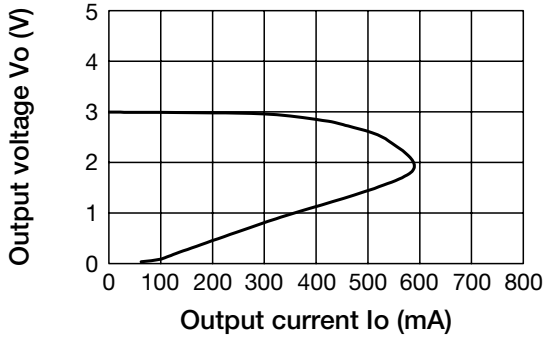

■ Ripple Rejection

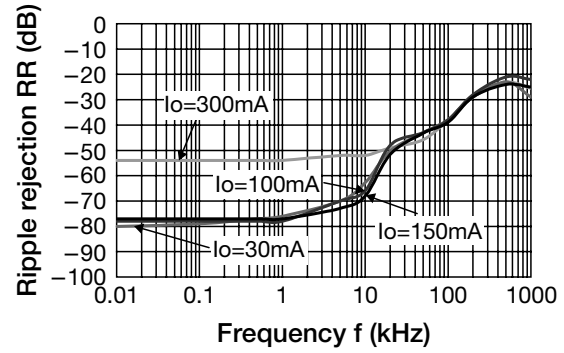

■ Load transient response (Io=10 → 100mA)

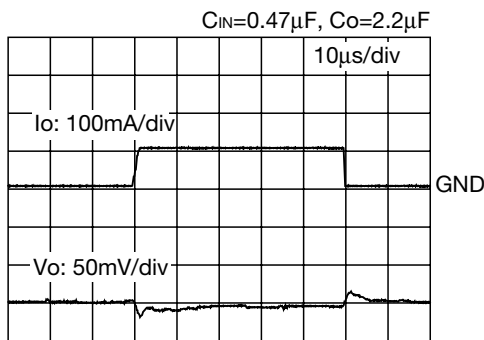

■ Load transient response (Io=10 → 150mA)

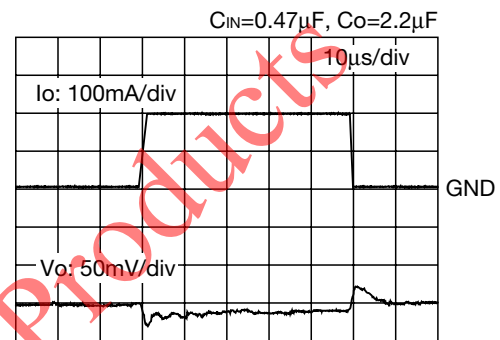

■ Load transient response (Io=10 → 300mA)

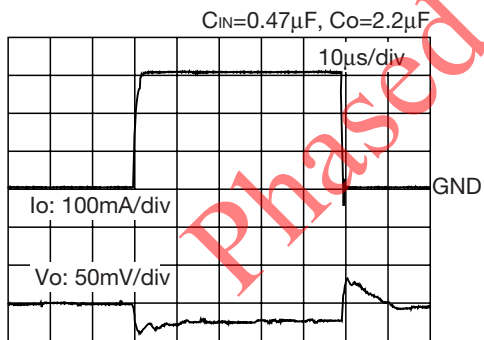

■ ESR Stable Area

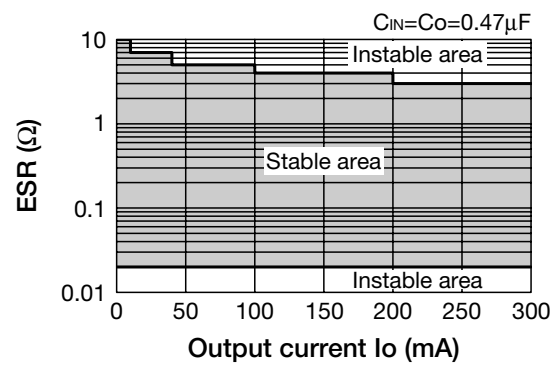



**Characteristics** (Except where noted otherwise,  $T_a=25^\circ\text{C}$ ,  $V_{DD}=V_{OUT}(\text{typ.}) + 1\text{V}$ ,  $V_{CE}=V_{DD}$ )

**Turn-On & Turn-Off Transient Responses**

