

Operating Instructions

Basic PR 5900/80



Translation of original operating instructions

9499 050 59100

Edition 2.2.0

11/06/2018

Release 1.11

Foreword

Must be followed!

Any information in this document is subject to change without notice and does not represent a commitment on the part of Minebea Intec unless legally prescribed. This product should be operated/installed only by trained and qualified personnel. In correspondence concerning this product, the type, name, and release number/serial number as well as all license numbers relating to the product have to be cited.

Note

This document is partially protected by copyright. It may not be changed or copied, and it may not be used without purchasing or written permission from the copyright owner (Minebea Intec). The use of this product constitutes acceptance by you of the above-mentioned provisions.

Table of contents

1	Introduction	4
1.1	Read the manual	4
1.2	This is what operating instructions look like	4
1.3	This is what lists look like	4
1.4	This is what menu items and softkeys look like	4
1.5	This is what the safety instructions look like	4
1.6	Hotline	5
2	Overview	6
2.1	General information	6
2.2	Equipment supplied	6
2.2.1	Components	6
2.2.2	Accessories (not included with the equipment supplied)	6
2.2.3	Plug-in cards	6
2.3	Function of application "Basic"	8
3	Operating	10
3.1	Display and operating elements	10
3.1.1	Overview	10
3.1.2	TFT user interface display	11
3.1.3	LEDs	13
3.1.4	Operating elements	14
4	Setting up the application menu	20
4.1	Configuration	20
4.1.1	Inputs and outputs	20
4.1.2	Functions/Applications/Procedures	21
4.1.3	Printing	24
4.1.4	Databases	25
4.1.5	Displaying weighing points	26
4.1.6	Printing	26
5	Getting started	27
5.1	Safety instructions	27
5.2	Switching on the device	27
5.3	User login	28
5.4	Configuration	29
5.4.1	General information	29
5.4.2	Configuring inputs	29
5.4.3	Configuring outputs	34
5.4.4	I/O cards test	39

5.4.5	Configuring the ModBus TCP master	39
5.4.6	Configuring the weighing process	42
5.4.7	Configuring the checkweighing process.....	43
5.4.8	Limit values: configuration.....	45
5.4.9	Configuring dialogs	49
5.4.10	Configuring binary weight output	50
5.4.11	Configuring printout	53
5.4.12	Configuring databases.....	56
5.4.13	Displaying weighing points.....	61
5.5	Switching off the device	64
6	Applications	65
6.1	General notes	65
6.2	Alibi memory	65
6.3	Weighing.....	65
6.4	Checkweighing.....	66
6.5	Terminal function	67
6.5.1	General	67
6.5.2	Control unit.....	67
6.5.3	Predefined functions.....	68
6.5.4	Predefined functions with predefined texts.....	74
7	Fieldbus interface	76
7.1	General notes	76
7.2	Scale protocol.....	76
7.2.1	General notes	76
7.2.2	Data exchange range	76
7.2.3	Function numbers.....	77
8	SPM	84
8.1	General information	84
8.2	Elementary data types.....	84
8.3	Addressing.....	85
8.4	System data weighing point A.....	85
8.5	System data weighing point B.....	91
8.6	System data weighing point C.....	97
8.7	System data weighing point D	102
8.8	Digital and analog inputs and outputs.....	108
8.9	ModBus TCP modules.....	108
8.10	Freely assigned ranges	110
8.11	Status of the Alibi memory.....	112
9	Tilt correction	113
9.1	General	113

- 9.2 Performing tilt correction..... 114
- 10 Printouts..... 118**
- 10.1 General notes 118
- 10.2 Basic-Configuration data 118
- 10.3 Tickets..... 118
- 10.3.1 General notes 118
- 10.3.2 Tickets and labels without NLE (NiceLabelExpress) 119
- 10.3.3 Tickets and labels with NLE (NiceLabelExpress) 119

1 Introduction

1.1 Read the manual

- Please read this manual carefully and completely before using the product.
- This manual is part of the product. Keep it in a safe and easily accessible location.

1.2 This is what operating instructions look like

1. - n. are placed before steps that must be done in sequence.
 - ▶ is placed before a step.
 - ▷ describes the result of a step.

1.3 This is what lists look like

- indicates an item in a list.

1.4 This is what menu items and softkeys look like

[] frame menu items and softkeys.

Example:

[Start]- [Applications]- [Excel]

1.5 This is what the safety instructions look like

Signal words indicate the severity of the danger involved when measures for preventing hazards are not followed.

DANGER

Warning of personal injury

DANGER indicates death or severe, irreversible personal injury which will occur if the corresponding safety measures are not observed.

- ▶ Take the corresponding safety precautions.

WARNING

Warning of hazardous area and/or personal injury

WARNING indicates that death or severe, irreversible injury may occur if appropriate safety measures are not observed.

- ▶ Take the corresponding safety precautions.

CAUTION

Warning of personal injury.

CAUTION indicates that minor, reversible injury may occur if appropriate safety measures are not observed.

- ▶ Take the corresponding safety precautions.

NOTICE**Warning of damage to property and/or the environment.**

NOTICE indicates that damage to property and/or the environment may occur if appropriate safety measures are not observed.

- ▶ Take the corresponding safety precautions.
-

Note:

User tips, useful information, and notes.

1.6 Hotline

Phone: +49.40.67960.444

Fax: +49.40.67960.474

eMail: help@minebea-intec.com

2 Overview

2.1 General information

These operating instructions describe the configuration and operation of the "Basic" application.

For installation, basic configuration, and calibration of the device, please refer to the PR 5900 installation manual and the operating instructions.

2.2 Equipment supplied

2.2.1 Components

The Basic product consists of the following components:

- Maxxis 5 basic unit with "BIOS," "firmware" and "Basic"
- Manuals in PDF format on CD-ROM

The "Basic" application requires installation of the following programs in the device:

- BIOS
- Firmware
- Application "Basic"

PR 1721/5x or PR 1721/7x fieldbus cards are supported, see Chapter [2.2.3](#).

The application supports Alibi memory, see Chapter [2.2.2](#).

2.2.2 Accessories (not included with the equipment supplied)

- Plug-in cards for Option-1, Option-2 and Option-FB, see Chapter [2.2.3](#)
- Software (license):
 - PR 1792/13 OPC server communication
 - Alibi memory
 - Tilt correction
- Scales:

A maximum of 4 scales can be controlled and displayed.

- PR 5900/10 (W1) Internal weighing electronics (max. 2)
- PR 5900/10 (WE1) Internal Ex weighing electronics (max. 1)
- Platform/scale with xBPI protocol (max. 3)

The digital load cells (of type Pendeo) are connected over a maximum of 2 serial RS-485 interfaces and a digital connection counter.

2.2.3 Plug-in cards

Product	Description	Position
PR 5900/04 2 x RS-485 serial inter- faces	The interface can be configured by software. For further information, refer to the PR 5900 installation manual.	Option-1 and/or Option-2

Product	Description	Position
PR 5900/07 1 analog input 1 analog output	Analog input: internal 14 bits binary = 20,000 counts, @ e.g. 0...20 mA/0...10 V Analog output: internal 16 bits = 65,536 counts, resolution of 20,000 @ 20 mA For further information, refer to the PR 5900 installation manual.	Option-1 and/or Option-2
PR 5900/10 (W1) Weighing electronics	Internal weighing electronics for connecting load cells or weighing platforms in non-Ex areas. A maximum of two internal weighing electro- ronics units can be inserted. For further information, refer to the PR 5900 installation manual.	WP A and/or WP B
PR 5900/10 (WE1) Weighing electronics with Ex approval	Internal weighing electronics for connecting load cells or weighing platforms in Ex areas. A maximum of one internal weighing electro- ronics unit can be inserted. For further information, see Option WE1 ad- ditional information.	WP A
PR 5900/12 4 digital inputs 4 digital outputs	4 passive opto-decoupled inputs 4 relay outputs with potential-free change- over contacts For further information, refer to the PR 5900 installation manual.	Option-1 and/or Option-2
PR 5900/13 4 digital inputs 4 digital outputs	4 active opto-decoupled inputs 4 relay outputs with potential-free change- over contacts For further information, refer to the PR 5900 installation manual.	Option-1 and/or Option-2
PR 5900/17 6 digital inputs 8 digital outputs	6 passive opto-decoupled inputs 8 passive opto-decoupled outputs For further information, refer to the PR 5900 installation manual.	Option-1 and/or Option-2
PR 5900/32 2 x RS-232 serial inter- faces	The interface can be configured by software. For further information, refer to the PR 5900 installation manual.	Option-1/FB and/or Option-2
C1 Module	Connection for remote terminal PR 5900/61, PR 5900/71 For further information, refer to the PR 5900 installation manual.	Remote termi- nal
CX1 Module with Ex appro- val	Connection for Ex remote terminal PR 5900/60, PR 5900/70 For further information, see Option CX1 ad- ditional information.	Remote termi- nal

Product	Description	Position
PR 1721/51 ProfiBus-DP	ProfiBus DP V0 slave with 9.6 kbit/s...12 Mbit/s, baud rate auto-detection For further information, refer to the PR 5900 installation manual.	Option-FB
PR 1721/54 DeviceNet	DeviceNet master-slave with 125, 250, and 500 kbit/s For further information, refer to the PR 5900 installation manual.	Option-FB
PR 1721/56 ProfiNet I/O	ProfiNet I/O with 10 Mbit/s and 100 Mbit/s, auto-detection (10/100, HalfDX/FullDX) For further information, refer to the PR 5900 installation manual.	Option-FB
PR 1721/57 EtherNet IP	EtherNet IP with 10 Mbit/s and 100 Mbit/s, auto-detection (10/100, HalfDX/FullDX) For further information, refer to the PR 5900 installation manual.	Option-FB
PR 1721/76 ProfiNet I/O 2-port	ProfiNet I/O with 10 Mbit/s and 100 Mbit/s, auto-detection (10/100, HalfDX/FullDX) For further information, refer to the PR 5900 installation manual.	Option-FB
PR 1721/77 EtherNet IP 2-port	EtherNet IP with 10 Mbit/s and 100 Mbit/s, auto-detection (10/100, HalfDX/FullDX) For further information, refer to the PR 5900 installation manual.	Option-FB

2.3 Function of application "Basic"

The "Basic" application represents the indicator function for the Maxxis 5 device.

Weight values can be printed and, at the same time, saved to an internal Alibi memory.

The saved data can be viewed and printed.

Via communication, values and signals can be read from and written to the Basic controller. It can also be used as an efficient remote terminal. This means that messages can be displayed from a higher-level system, operation dialogs can be conducted and texts or values can be edited.

A PC can communicate with the Basic controller via OPC. The transmission takes place by Ethernet.

A PLC can communicate with the Basic controller via a fieldbus.

Two weighing electronics units can be installed internally in a Basic controller.

Other features at a glance:

- Preset tare values can be saved
- Input of defined texts for the terminal function
- Internal Alibi memory (activation via license); not possible with user weighing point
- Weight printout via configurable report

- Configurable limit switch (3 limits per scale, which can be combined with conditions and actions.)
- Configurable digital and analog inputs and outputs (requires additional plug-in cards)
- Remote-controlled operation dialog via color display and keypad
- Tilt correction (enabled by license)

3 Operating

3.1 Display and operating elements

3.1.1 Overview

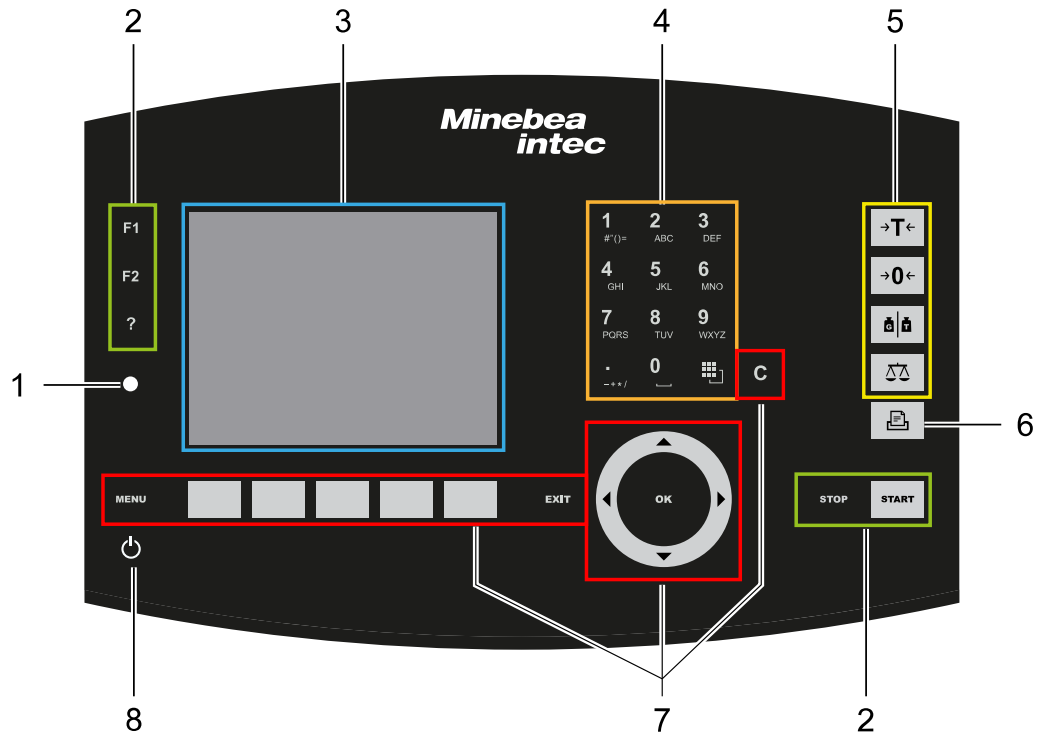

No.	Name
Display elements	
1	LED status display, see Chapter 3.1.3
3	5.7" TFT color display, see Chapter 3.1.2
Operating elements, see Chapter 3.1.4.1	
2	Function keys
4	Alphanumeric keypad
5	Indicator keys
6	Application keys
7	Navigation/menu keys, incl. soft keys
8	On/off button

3.1.2 TFT user interface display

The TFT color graphics display can show weight values of up to 7 digits with decimal point and plus or minus sign. The available mass units are t, kg, g, mg, lb, or oz.





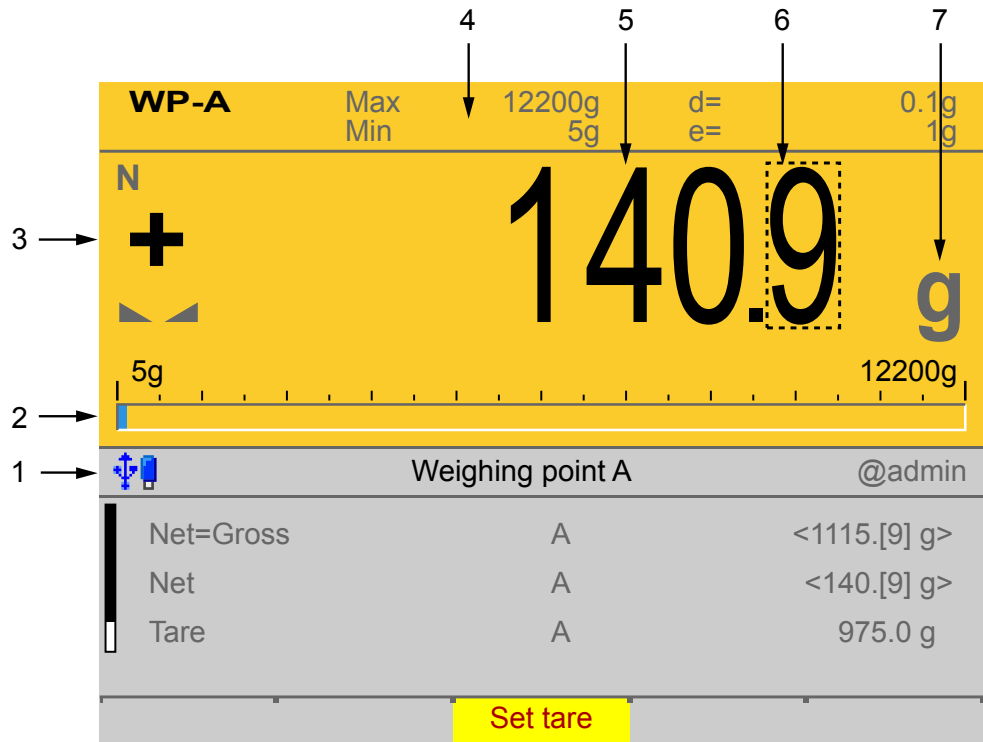

The lb and oz units are not permitted for use in legal metrology in the EU and EEC.

Below the weight display, the currently displayed weight is shown in a bar graph that indicates the percentage of the maximum capacity (Max). 0 is on the left, and 100% on the right.













No.	Description
1	Info line
2	Bar graph
3	Weight type/plus or minus sign/standstill
4	Status display
5	Weight value
6	Border around decimal place
7	Symbols/mass unit

Weight type/plus or minus sign	Description
B	Gross weight
G	Gross weight in NTEP or NSC mode
N	Net weight (Net = gross - tare)
T	Tare weight

Weight type/plus or minus sign	Description
PT	Preset tare, not tared
No display	- Test value - Gross, not tared
User	Additional weight display, application-dependent
Setp	Additional weight display, application-dependent
Diff	Additional weight display, application-dependent
+	Positive value
-	Negative value
Standstill/zero/batching/monitoring	Description
	Weight value standstill
	The gross weight value is within $\pm 1/4$ d of zero
	Batching mode: flashes when batching is "stopped"; rapid flashing indicates "error status"
	Pendeo load cells: Plausibility monitoring; the average deviation of the individual load cells is calculated
	Pendeo load cells: Temperature monitoring; 1-n load cells above or below permissible temperature
Symbols/mass unit	Description
	Value not permissible in legal metrology (e.g., 10x resolution, tilt correction active)
R1	Range 1
R2	Range 2
R3	Range 3
WP A	Weighing point A
WP B	Weighing point B
WP C	Weighing point C
WP D	Weighing point D
Max	Maximum capacity (weighing range)
Min	Minimum weight
	Only if W&M is selected: Border around inadmissible decimal place.
t, kg, g, mg, lb, oz	These mass units are available.

Status icons in the info line

Icon	Description
	Remote control via VNC (Virtual Network Computing) is active.
	General warning
	<ul style="list-style-type: none"> - The clock battery is empty. - The standby battery is empty.
	The standby battery is too hot and is not charging. If this does not go away, the ambient temperature must be checked, see PR 5900 installation manual under [Technical data] - [Environmental influences] - [Ambient conditions].
	<ul style="list-style-type: none"> - An unsupported USB device is connected. - The maximum current of $i_{\max} = 200$ mA has been exceeded.
	Check newly connected devices.
	USB stick was recognized and is operational.
	Stick is in use and may not be removed.
	Conflict in the network settings of the IP address.
	Interface (C1/CX1) was detected. However, there is no connection to the operator terminal.

3.1.3 LEDs

Operating status	Color	LED status	Description
Normal operation		Off	
System ready (standby)	Red	Continuous illumination	The display is switched off.
Power interruption <5 seconds	Red	Slow flashing	After 5 seconds, the device returns to normal operation.
Power interruption >5 seconds	Red	Fast flashing	The device is running a data backup. Once power is restored, the device returns to normal operation (LED off).
After the data backup, there is still a power interruption.		Off	The device switches off.
		Off	The device initiates a warm start, see PR 5900 operating instructions.





3.1.4 Operating elements

- Operation using the front-panel keys, see Chapter [3.1.4.1](#)
- Operation using the soft keys, see Chapter [3.1.4.2](#)
- Operation using the navigation keys, see Chapter [3.1.4.3](#)
- Operation using the PC keys, see Chapter [3.1.4.4](#)

3.1.4.1 Operation using the front-panel keys

The following table shows the basic meanings of the symbols on the front-panel keys. Depending on the applications, the keys may also have other meanings.

Indicator keys

Key	Description
	Set tare The current gross weight is stored in the tare memory, provided that <ul style="list-style-type: none"> - the weight value is stable. - the device is not in error status. (Function is dependent on configuration)
	Sets gross weight to zero, provided that <ul style="list-style-type: none"> - the weight value is stable. - weight is within zero setting range. (Function is dependent on configuration)
	Display gross/tare weight Pressing the key switches to the next weight (only with tared scale). During calibration, pressing this key displays the weight for 5 seconds with 10x resolution.
	Switching of display between the weighing points: <ul style="list-style-type: none"> - WP-A - WP-B - WP-C - WP-D

Application keys

Key	Description
	Starts an application-specific printout.

Navigation keys



Key	Description
▲	Scroll up in the menu.
▼	Scroll down in the menu.

Key	Description
◀	<ul style="list-style-type: none"> - Cursor to the left - Selection - Exit menu window.
▶	<ul style="list-style-type: none"> - Cursor to the right - Selection - Confirm input/selection.

Menu keys

Key	Description
OK	Confirm input/selection.
EXIT	<ul style="list-style-type: none"> - Cancel entry/selection (after a confirmation prompt) without saving the change. - Exit parameters/menu window.
C	Pressing the delete key deletes individual characters (within an entry) or whole strings of characters.
Soft key 1 to 5	Select appropriate menu function, see also Chapter 3.1.4.2 .
MENU	Switch to the operating menu.

Function keys



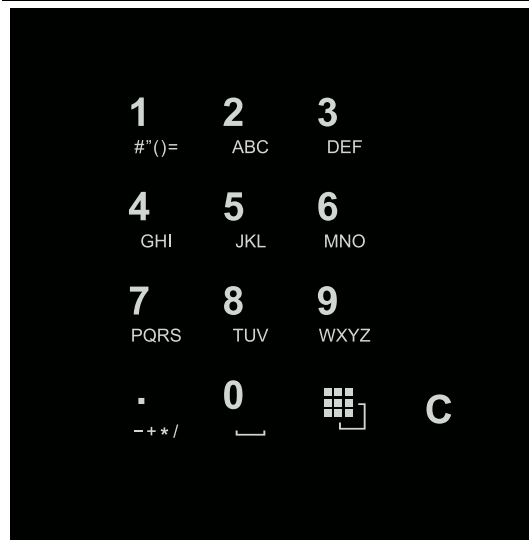

Key	Description
F1	Assigned to a defined function (see system menu [System setup] - [Operating parameters]).
F2	Assigned to a defined function (see system menu [System setup] - [Operating parameters]).
?	Displays the relevant help window.
	<ul style="list-style-type: none"> - Turns off the display. - Ignores all key presses. - LED is red. <p>Pressing again will switch the display on again.</p>
	Starts a printout of previous dialog display, see Chapter 5.4.9 .
	Same functions as the indicator key EXIT .

Alphanumeric keypad

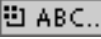

Toggle key

Pressing key switches between the following functions:

-  ABC..
Uppercase letters
-  abc..
Lowercase letters
-  IME...
Pinyin
When Chinese has been selected or set under [Operating parameters] - [Input method].
- Hepburn
When Japanese has been selected or set under [Operating parameters] - [Input method].
-  123..
Numbers
-  unit
Units
Select the unit using the cursor keys ▲/▼ and confirm using the key **OK**.

Note:

It is also possible to select a unit by double-clicking on the shift key.

2

ABC

Input without the character table

Pressing once displays the corresponding first character, e.g., "A", at the cursor position. After pressing twice, "B" is displayed at the cursor position and after pressing three times, "C" is displayed.

Press the cursor keys ▼/▲ to finish entering a character or wait approx. 2 seconds.

If only numeric values are required for input, letters are not enabled.

Press the cursor key ◀ within an entry to return to the previous character.

Press the cursor key ▶ within an entry to select the next character.

Within an entry, pressing the delete key **C** deletes the character to the left of the cursor.

Outside of an input, pressing the delete key **C** deletes the whole string of characters.

**Input with the character table**

Double-clicking on the key displays the character table.

Only characters authorized for this input are displayed.

Note:

Only possible when entering text, not when entering numbers or weights. The switching function is turned off.

Procedure:

- Highlight the desired character with the cursor.
- The selected character is shown magnified in the field at the top right.
- Press the key **OK** to enter the character in the input field.
- Another double-click on the toggle key and other characters can be input as described previously.

Input field

In principle:

If alphanumeric characters are already present in the input field of the selected line, they will be completely overwritten after immediate entry.

If alphanumeric characters are already present in the input field of the selected line, you can press the cursor key ▶ to select the characters to be overwritten and overwrite them.

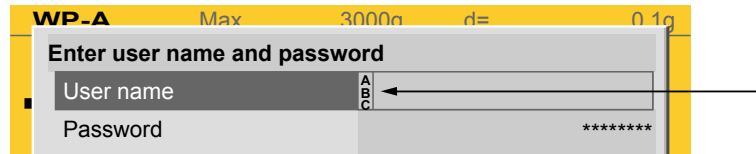

In front of the input field it is indicated whether numeric and/or alphabetic characters can be entered (see arrow).

Switch to the input field using the cursor key ▶.

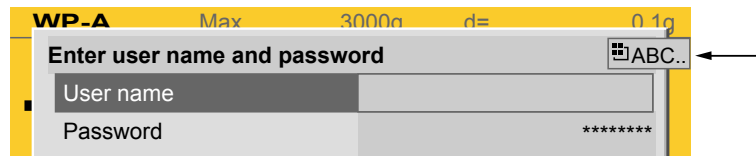

The respective options are displayed (see arrow).

Note:

The character table is turned off.

Keyboard shortcuts

STOP Trigger a cold start, see also PR 5900 operating manual.

+
EXIT

3.1.4.2 Operation using softkeys

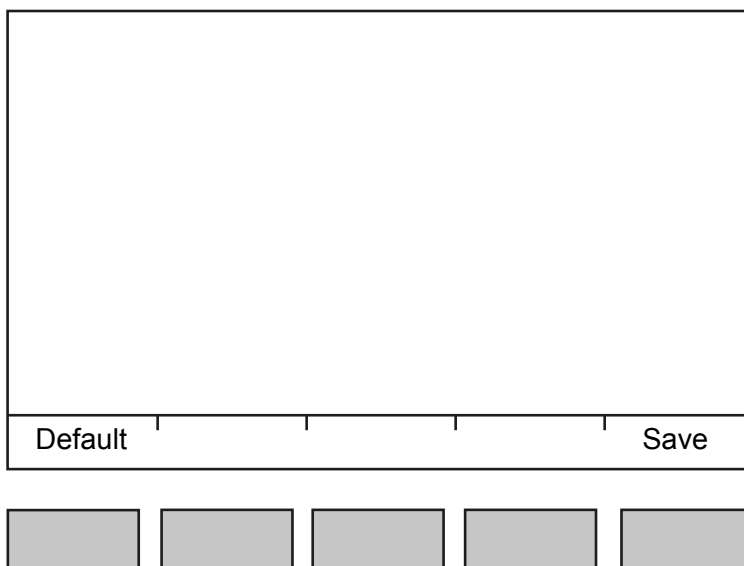

The functions of the five softkeys below the graphic display are indicated in the bottommost text line of the display. Softkey functions shown in gray cannot be selected at the active menu level or with the current access privileges.

In the descriptions of operating sequences which entail the use of softkeys, the softkey function to be selected is shown in square brackets; the softkey symbol is not displayed; example: [Save].

3.1.4.3 Navigation key operation

Menu

The cursor keys, the **OK** and **EXIT** keys are used to navigate through the menus.

Parameters

Use the ▼/▲ cursor keys to select the individual parameters.

Use the **OK** key to confirm the selection.

The required values | texts are entered via the alphanumeric keys.

The **OK** key is used to check the box.



If the list of parameters is long, a vertical bar graph on the left (black and gray) shows which part of the list is displayed.

An existing selection list is indicated by an arrow ► following it.

The parameter is selected using the **OK** key.

3.1.4.4 Operation via PC keys

The device can also be operated using a PC keyboard. The corresponding key assignment is shown in the table below:

PC keyboard	Front keypad
F1	F1
F2	F2
F3	?
F4	MENU
F5...F9	Softkey 1...5
F10	
F11	
F12	
ESC	EXIT
Cursor keys: ↑, ↓, ←, →	▲, ▼, ◀, ▶
Enter key: ↵	OK
Backspace key: ←	C
Numeric keypad	Alphanumeric keypad

4 Setting up the application menu

- Weighing
Display of weight values and the parameters set under [Configuration] - [Functions/ applications/procedures] - [Weighing]
- Check weighing
Display of weight values and the parameters set under [Configuration] - [Functions/ applications/procedures] - [Check weighing]
- Device employed as terminal
Weight display

4.1 Configuration

Configuration	
└ Inputs and outputs	See Chapter 4.1.1 .
└ Functions/applications/procedures	See Chapter 4.1.2 .
└ Printout	See Chapter 4.1.3 .
└ Databases	See Chapter 4.1.4 .
└ Display weighing points	See Chapter 4.1.5 .
└ Printing	Print configuration, see Chapter 4.1.6 .

4.1.1 Inputs and outputs

Configuration	
└ Inputs and outputs	
└ Inputs	Function allocation for installed input cards, see Chapter 4.1.1.1 .
└ Outputs	Function allocation for installed output cards, see Chapter 4.1.1.2 .
└ ModBus-TCP master	See Chapter 4.1.1.3

4.1.1.1 Inputs

Configuration	
└ Inputs and outputs	
└ Inputs	Function assignment for installed input cards.

Inputs	
└ Option	Selection: Option-1, Option-2, Internal, remote terminal if necessary
└ Type	Display only
└ Input	1...4
└ SPM address %MX	See SPM table in Chapter 8 .
└ Default	Settings are reset to factory settings.
└ Input-	Switch to the previous input.
└ Input+	Switch to the next input.
└ Save	The settings are saved.

4.1.1.2 Outputs

Configuration
└ Inputs and outputs

<ul style="list-style-type: none"> — Outputs 	<p>Function assignment for installed output cards.</p>
<ul style="list-style-type: none"> Outputs — Option — Type — Output — SPM address %MX — Default — Output- — Output+ — Save 	<p>Selection: Option-1, Option-2, Internal, remote terminal if necessary</p> <p>Display only</p> <p>1...4</p> <p>See SPM table in Chapter 8.</p> <p>Settings are reset to factory settings.</p> <p>Switch to the previous output.</p> <p>Switch to the next output.</p> <p>The settings are saved.</p>

4.1.1.3 ModBus-TCP master

<ul style="list-style-type: none"> Configuration — Inputs and outputs — ModBus-TCP master

<ul style="list-style-type: none"> ModBus-TCP master — Communication error — ModBus-TCP module — Activate module — IP address — I/O type — Input — SPM address %MX — Default — Input/Output - — Input/Output + — Save 	<p>Selection: Cancel, Show message</p> <p>Selection: Phoenix 1...8</p> <p>Check the <input checked="" type="checkbox"/> box to activate the module. The menu expands.</p> <p>Enter the IP address of the module.</p> <p>Selection: Digital input, Digital output</p> <p>1...16</p> <p>See SPM table in Chapter 8.</p> <p>Settings are reset to factory settings.</p> <p>Switch to previous Input/Output.</p> <p>Switch to next Input/Output.</p> <p>The settings are saved.</p>
---	---

4.1.2 Functions/Applications/Procedures

<ul style="list-style-type: none"> Configuration — Functions/Applications/Procedures — Weighing — Checkweighing — Limits — Dialogs — Tilt correction — Binary weight output 	<p>See Chapter 4.1.2.1</p> <p>See Chapter 4.1.2.2</p> <p>See Chapter 4.1.2.3</p> <p>See Chapter 4.1.2.4</p> <p>See Chapter 4.1.2.5</p> <p>See Chapter 4.1.2.6</p>
---	---

4.1.2.1 Weighing

<ul style="list-style-type: none"> Configuration — Functions/Applications/Procedures — Weighing

<ul style="list-style-type: none"> Weighing — Weighing point — Instructions 	<p>Weighing point A–D</p> <p>Enter text (20 characters)</p>
---	---

<ul style="list-style-type: none"> — e.g.: Customer — Use preset tare — Save alibi — Default — Save 	<p>Transferred from the application database: Select record.</p> <p>Check the <input checked="" type="checkbox"/> box to use the preset tare.</p> <p>Check the <input checked="" type="checkbox"/> box to activate the storage of printed weight values in the Alibi memory.</p> <p>Settings are reset to factory settings.</p> <p>The settings are saved.</p>
--	--

4.1.2.2 Checkweighing

<ul style="list-style-type: none"> — Configuration — Functions/Applications/Procedures <ul style="list-style-type: none"> — Checkweighing

<ul style="list-style-type: none"> — Checkweighing — Weighing point — Instructions — e.g.: Customer — Weighing mode — Only display set point — Set point — Set point min. — Set point max. — Save alibi — Show dialogs before printing — Default — Save 	<p>Weighing point A–D</p> <p>Enter text (20 characters)</p> <p>Transferred from the application database: Select record.</p> <p>Gross, net</p> <p>Check the <input checked="" type="checkbox"/> box to confirm the selection. The set point can therefore no longer be changed in weighing mode.</p> <p>Enter value</p> <p>Enter value < set point</p> <p>Enter value > set point</p> <p>Check the <input checked="" type="checkbox"/> box to activate the storage of printed weight values in the Alibi memory.</p> <p>Check the <input checked="" type="checkbox"/> box to confirm the selection.</p> <p>Settings are reset to factory settings.</p> <p>The settings are saved.</p>
--	---

4.1.2.3 Limit values

<ul style="list-style-type: none"> — Configuration — Functions/applications/procedures <ul style="list-style-type: none"> — Limit values
--

<ul style="list-style-type: none"> — Limit values — Weighing point — Limit value 1...3 On/Off <ul style="list-style-type: none"> — Action 1...3 On — Action 1...3 Off — Condition 1...3 On 	<p>Weighing point A...D</p> <p>Enter 0 ... Max (maximum capacity); take unit from calibration.</p> <p><None> marker 1...3 set, delete marker 1...3</p> <p><None> marker 1...3 set, delete marker 1...3</p> <p><No condition>, not active: Internal digital input 1...4, Current limit value 1...3, ADC error, Above MAX, Overload, Below zero, Exactly zero, Within zero setting range, Standstill, Not W&M approved (dimmed), Internal error = command error, Command executed, Power fail, Test active, Calibration is active, Set tare is active, Marker bit 1...3 active: Internal digital input 1...4, Current limit value 1...3, ADC error,</p>
---	---

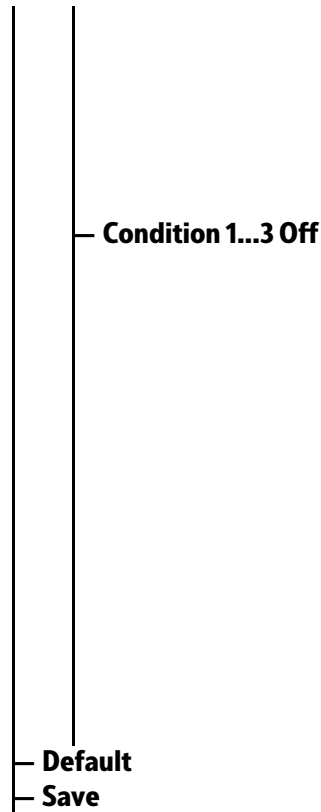

Above MAX, Overload, Below zero, Exactly zero, Within zero setting range, Standstill, Internal error = command error, Command executed, Power fail, Test active, Calibration is active, Set tare is active, Marker bit 1...3 active, Cannot be verified (dimmed)
 <No condition>, not active: Internal digital input 1...4, Current limit value 1...3, ADC error, Above MAX, Overload, Below zero, Exactly zero, Within zero setting range, Standstill, Not W&M approved (dimmed), Internal error = command error, Command executed, Power fail, Test active, Calibration is active, Set tare is active, Marker bit 1...3 active: Internal digital input 1...4, Current limit value 1...3, ADC error, Above MAX, Overload, Below zero, Exactly zero, Within zero setting range, Standstill, Internal error = command error, Command executed, Power fail, Test active, Calibration is active, Set tare is active, Marker bit 1...3 active, Cannot be verified (dimmed)
 Settings are reset to factory settings.
 The settings are saved.

4.1.2.4 Dialogs

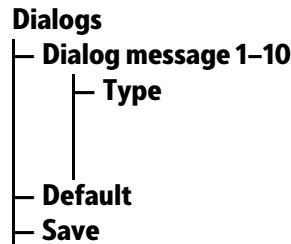

Free text without timeout, Free text with timeout, Text with user unit, Weight, Dialog reply: Yes or No, Tare before printing
 Settings are reset to factory settings.
 The settings are saved.

4.1.2.5 Tilt correction



Function can only be performed with a valid license, see Chapter 9.

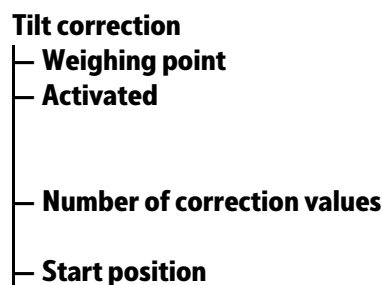

Weighing point A–D
 Check the box . The current weight is displayed during tilt correction to simplify the configuration.
 Enter 0–99 to define the number of correction values, including start and end points.

<ul style="list-style-type: none"> — End position — Default — Edit — Start — Apply — Save 	<p>Manually define the start position of the silo, for example, and use the "Accept" soft key to transfer it to the device.</p> <p>Manually define the end position of the silo, for example, and use the "Accept" soft key to transfer it to the device.</p> <p>Settings are reset to factory settings.</p> <p>Change the calculated points.</p> <p>Start the calculation. The manually launched tilting process must be performed very slowly, because the individual silo positions can only be calculated at a standstill.</p> <p>Transfer the start and end positions of the silo on the device.</p> <p>The settings are saved.</p>
---	--

4.1.2.6 Binary weight output

Configuration	
<ul style="list-style-type: none"> — Functions/Applications/Procedures <ul style="list-style-type: none"> — Binary weight output 	<p>With binary weight output, the current gross weight output of a weighing point will be given as a 12 bit binary weight.</p>

Binary weight output	
<ul style="list-style-type: none"> — Weighing point — Activated — Weight per count value — Output value — Default — Save 	<p>Weighing point A–D</p> <p>Check the box <input checked="" type="checkbox"/> to activate the binary weight output for the corresponding weighing point.</p> <p>Enter the value. This value corresponds to the weight to which the binary output will be scaled.</p> <p>Gross, Net</p> <p>Settings are reset to factory settings.</p> <p>The settings are saved.</p>

4.1.3 Printing

Configuration	
— Printing	
Printing	
<ul style="list-style-type: none"> — Parameters <ul style="list-style-type: none"> — Device name — Use NLE — Number of printouts — Print layout "Weighing" <ul style="list-style-type: none"> — Printer — Line 1–99 	<p>Enter alphanumeric characters.</p> <p>Check the <input checked="" type="checkbox"/> box to activate printing with NiceLabelExpress.</p> <p>See Chapter 10.3.3.</p> <p>Enter value.</p> <p>none, printer, ticket printer, printer 2</p> <p>The printers are assigned to the device under [System setup]- [Connected devices]</p> <p>Blank line, -----, Form feed, Device name, Weighing point, Sequence number, Date, Time,</p>

<ul style="list-style-type: none"> — Default — Insert — Delete — Save — Print layout "Check weighing" — Printer — Line 1–99 — Default — Insert — Delete — Save 	<p>Gross, Net, Tare, Header, Weighing mode; Dialog reply 1–10, Free number 1–3, Entered. weight, Entered string, Edited int, Edited real, field key name, field name 1–6</p> <p>Settings are reset to factory settings.</p> <p>Insert lines. 99 lines are possible in total.</p> <p>Delete the highlighted line.</p> <p>The settings are saved.</p> <p>none, printer, ticket printer, printer 2</p> <p>The printers are assigned to the device under [System setup]- [Connected devices]</p> <p>Blank line, -----, Form feed, Device name, Weighing point, Sequence number, Date, Time, Gross, Net, Tare, Header, Weighing mode; Dialog reply 1–10, Free number 1–3, Entered. weight, Entered string, Edited int, Edited real, field key name, field name 1–6</p> <p>Settings are reset to factory settings.</p> <p>Insert lines. 99 lines are possible in total.</p> <p>Delete the highlighted line.</p> <p>The settings are saved.</p>
--	---

4.1.4 Databases

Configuration
 — **Databases**

<p>Databases</p> <ul style="list-style-type: none"> — Preset tare <ul style="list-style-type: none"> — ID (1–999) — Tare name — Tare weight — New — Modify — Delete — Predefined texts <ul style="list-style-type: none"> — ID (1–999) — Tare name — Tare weight — New — Modify — Delete — Application database - field names <ul style="list-style-type: none"> — Field key name — Field name 1–6 	<p>Create records for defined tare values.</p> <p>Record no.</p> <p>Enter alphanumeric characters (max. 20).</p> <p>Display of the placed and transferred weight value.</p> <p>Create new record.</p> <p>Change highlighted record.</p> <p>Delete the highlighted line.</p> <p>Create records for texts to be displayed on the terminal.</p> <p>Record no.</p> <p>Enter alphanumeric characters (max. 20).</p> <p>Display of the placed and transferred weight value.</p> <p>Create new record.</p> <p>Change highlighted record.</p> <p>Delete the highlighted line.</p> <p>Note:</p> <p>Before making changes, the current database should be saved on the SD card or USB stick.</p> <p>Create new database (e.g.: materials/customer database).</p> <p>Enter alphanumeric characters (max. 20).</p>
--	---

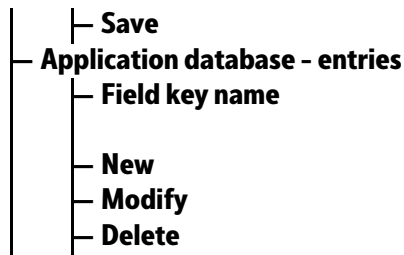

The input is saved.
 Add, edit and delete database entries.
 Create new database (e.g.: materials/customer database).
 Create new record.
 Change highlighted record.
 Delete the highlighted line.

4.1.5 Displaying weighing points

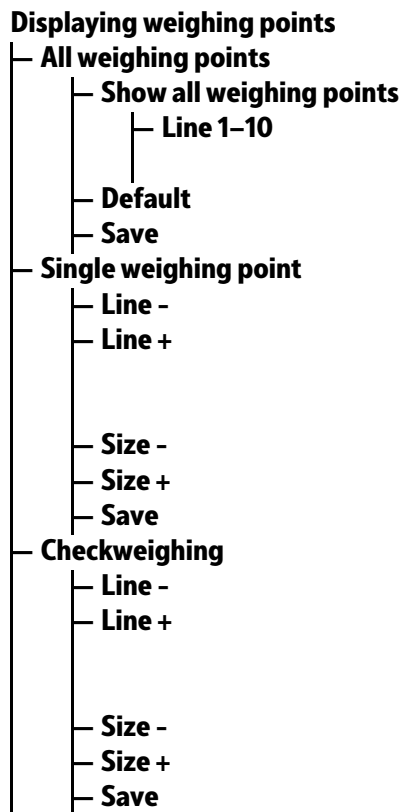

Check the box to display all weighing points.
 Gross, net, tare, limit 1-3, analog output 1+2, field key name, blank line
 Settings are reset to factory settings.
 The settings are saved.

Delete line
 Insert lines 1-8.
 Selections: Gross, net, tare, limit 1-3, analog output 1+2, field key name, field 1-6
 Reduce size of weight display.
 Increase size of weight display.
 The settings are saved.

Delete line
 Insert lines 1-8.
 Selections: Gross, net, tare, limit 1-3, analog output 1+2, field key name, field 1-6
 Reduce size of weight display.
 Increase size of weight display.
 The settings are saved.

4.1.6 Printing



Print configuration.

5 Getting started

5.1 Safety instructions

WARNING

Warning of a hazard area.

- ▶ It is essential that the safety instructions in Chapter 2 of the PR 5900 Installation manual are read before installation and commissioning!

5.2 Switching on the device

The device can be set up as follows:

- Via keys on the front of the device
- Via an external PC keyboard
- Via a notebook/PC using the VNC software (included on the CD)
- Via a notebook/PC using an Internet browser

When the device is powered up, the following is shown on the display and/or notebook/PC:

Checking... Booting... Restoring...	The device is booting up.
PR 5900	<ul style="list-style-type: none"> - The instrument type is displayed, PR 5900 - BIOS version - Firmware version - Automatic display test - Weight display
No signal	Error message: no load cells are connected, see also PR 5900 operating instructions.
No values from scale	<p>Error message: no communication with the xBPI scale, see also PR 5900 operating instructions.</p> <p>Error message: unable to read weight values from the ADU (analog-digital converter); see also PR 5900 operating instructions.</p>
Scale not ready	Error message: no load cells or scale connected, see also PR 5900 operating instructions.

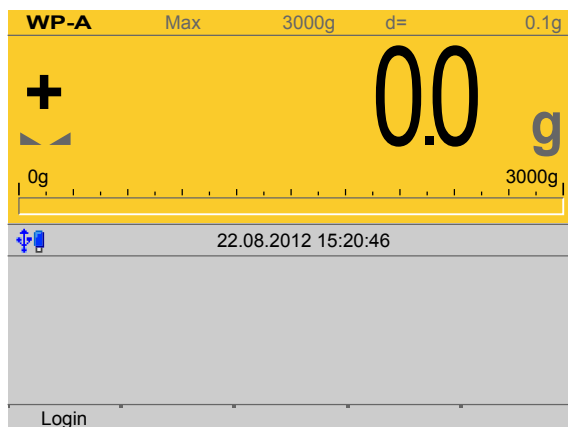

The weight display is shown.

Check the date and time after first turning on the device, see PR 5900 operating instructions.

5.3 User login

User management is **not** activated by default.

Activate user management with the menu item [System setup] - [User management], see also PR 5900 operating instructions.

The application rights "Administrator", "Supervisor" and "Operator" are preset and cannot be changed.

The application rights are defined as follows:

- "Administrator" is allowed to edit firmware and application settings and order data.
- "Administrator" can create new users with all rights, see PR 5900 operating instructions.
- "Supervisor" is allowed to edit application settings and order data.
- "Operator" is allowed to start weighing and edit order data.

Note:

An authorized user must log in to start or configure the application.

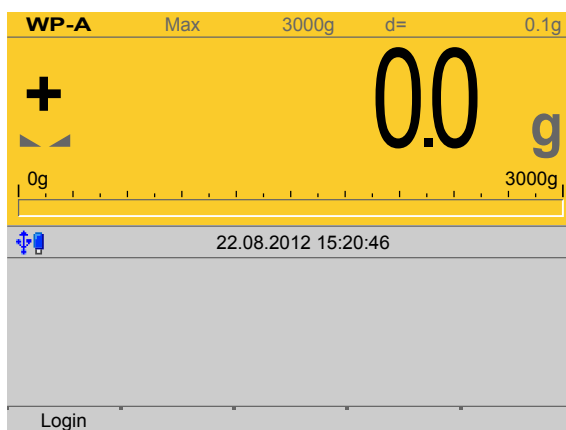

1. Press the [Login] soft key.

2. Enter the password using the keyboard and confirm. If user management is not active, you only need to confirm.
 - ▷ The operating menu is displayed.

The application and system menus are selected here.

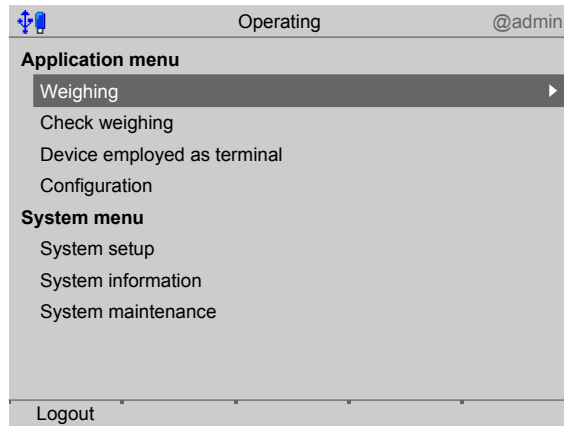

3. Select and confirm the desired menu item using the cursor.

5.4 Configuration

5.4.1 General information

In this menu item, application is configured.

Note:

When user management is active, the configuration can only be performed if a user with application rights "Supervisor" or "Administrator" is logged in.

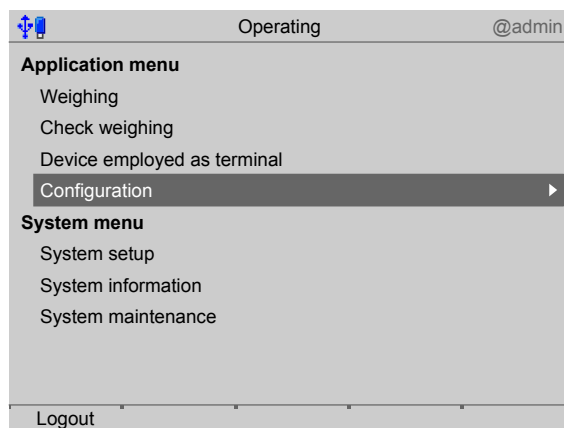

- ▶ Select and confirm [Configuration] using the cursor.

5.4.2 Configuring inputs

This function is required to configure the analog and digital inputs.

- Analog input, see Chapter [5.4.2.1](#)
- Digital inputs, see Chapter [5.4.2.2](#)
- I/O cards test, see Chapter PR 5900 operating instructions.

When changing the I/O card type, the configuration data remains unchanged. Functions for a non-installed scale can be selected, however, they are without effect.

The free and assigned SPM addresses are documented in Chapter 8.

If several inputs are assigned to an SPM address, the input with the higher number prevails.

Option-1 = No. 1

Option-2 = No. 2

Built-in = No. 3

Unused inputs are ignored.

The card type and the available inputs and outputs are detected automatically.

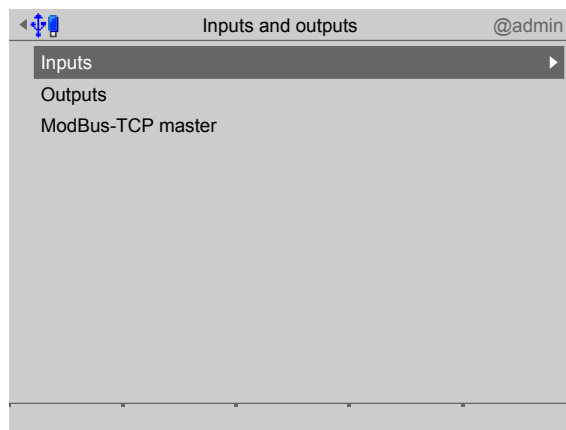

- ▶ In the operating menu, select and confirm [Configuration] - [Inputs and outputs] - [Inputs].

5.4.2.1 Analog input

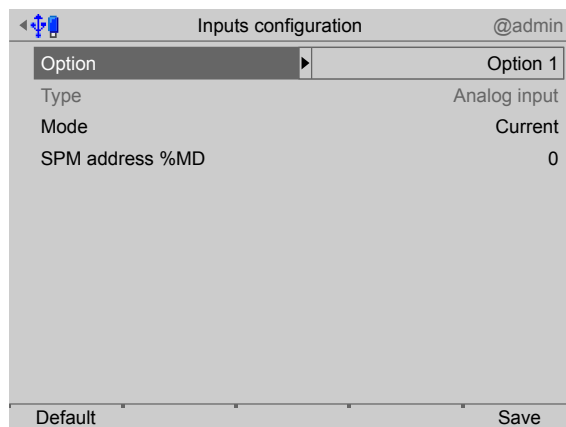

1. Select and confirm [Option] using the cursor.
 - ▷ A selection window opens.

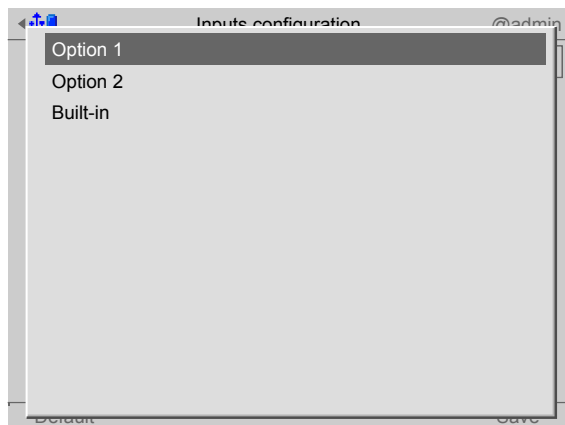

2. Select and confirm the corresponding interface using the cursor.

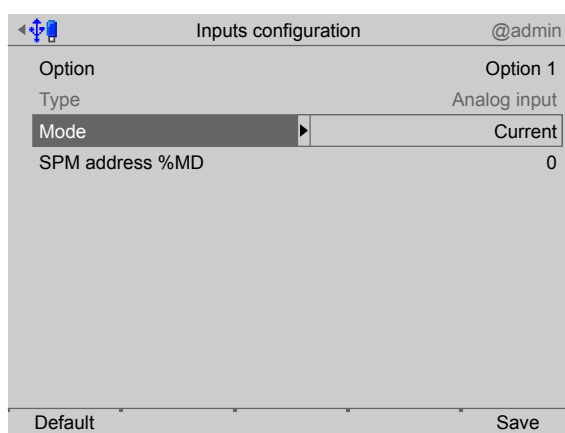

3. Select and confirm [Mode] using the cursor.

▷ A selection window opens.

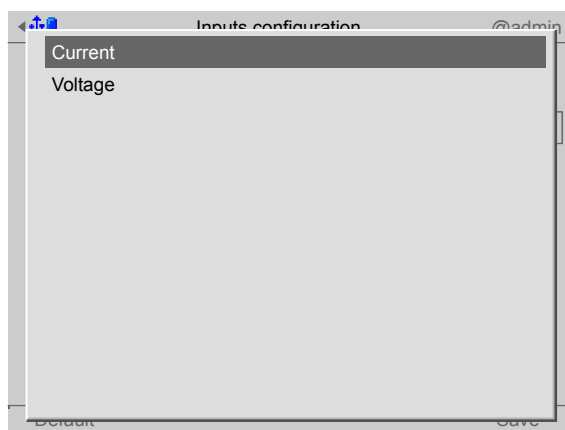

4. Select and confirm the appropriate input type using the cursor (see also PR 5900 operating instructions).

Inputs configuration		@admin
Option	Option 1	
Type	Analog input	
Mode	Current	
SPM address %MD	127	

Default Save

5. Select [SPM address %MD] using the cursor.
6. Use the keyboard to enter and confirm a free address %MD (see Chapter 8).
7. Press the [Default] soft key to return to the factory settings, if required.
8. Press the [Save] soft key to save the settings.

Note:

If the SPM address is equal to 0, the analog value is not written to the SPM.

General:

No reserved SPM addresses are overwritten by the analog inputs.

5.4.2.2 Digital inputs

Inputs configuration		@admin
Option	Built-in	
Type	Digital inputs	
Input	1	
SPM address %MX	-1	

Default Input - Input + Save

1. Select and confirm [Option] using the cursor.
 - ▷ A selection window opens.

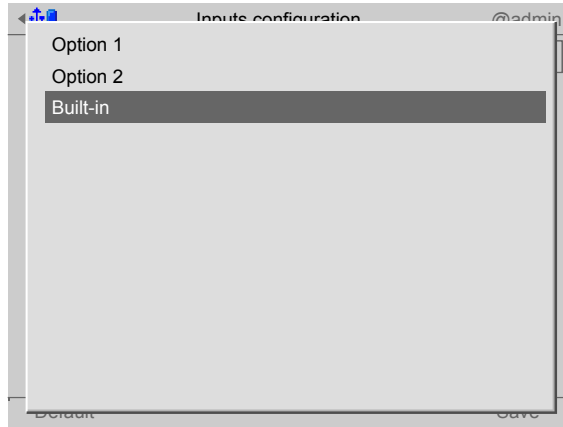

2. Select and confirm the corresponding interface using the cursor.

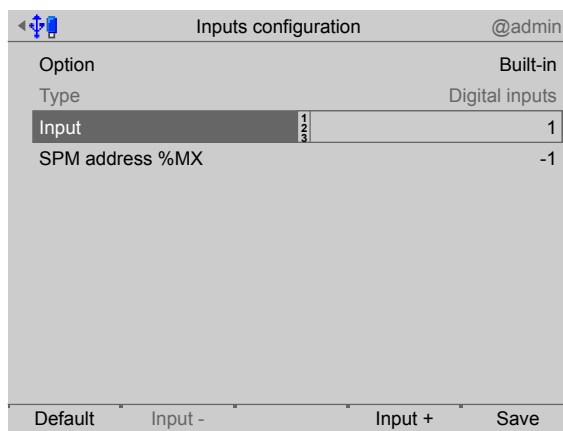

3. Select [Input] using the cursor.
4. Confirm input "1".

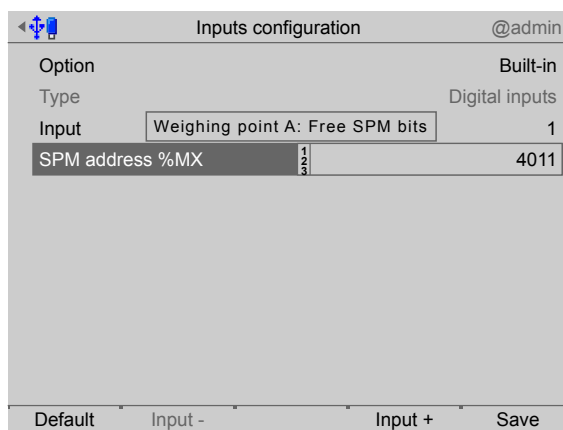

5. Select [SPM address %MX] using the cursor.
6. Use the keyboard to enter and confirm a free address %MX (see also PR 5900 operating instructions).

Note:

A negative address inverts the function.

Option	Built-in
Type	Digital inputs
Input	2
SPM address %MX	-1

Default Input - Input + Save

7. Press the [Input+] soft key to configure the next input.

Option	Built-in
Type	Digital inputs
Input	2
SPM address %MX	4012

Default Input - Input + Save

8. Select [SPM address %MX] using the cursor.
 9. Use the keyboard to enter and confirm a free address %MX (see also PR 5900 operating instructions).
 10. Configure inputs 3+4 in the same way.
 11. Press the [Default] soft key to return to the factory settings, if required.
 12. Finally, press the [Save] soft key to save the settings.

Note:

The value of the digital input is not written to the SPM if the address = 0 (inactive).

5.4.3 Configuring outputs

This function is required to configure the analog and digital outputs.

- Analog output, see Chapter [5.4.3.1](#).
- Adapting the analog output, see PR 5900 operating instructions.
- Digital inputs, see Chapter [5.4.3.3](#).
- I/O cards test, see PR 5900 operating instructions.

When changing the I/O card type, the configuration data remains unchanged. Functions for a non-installed scale can be selected, however, they are without effect.

The free and assigned SPM addresses are documented in Chapter [8](#).

The assignment of SPM addresses to a scale is only valid if the scale exists.
 Non-allocated outputs are switched off.
 The card type and the available inputs and outputs are detected automatically.

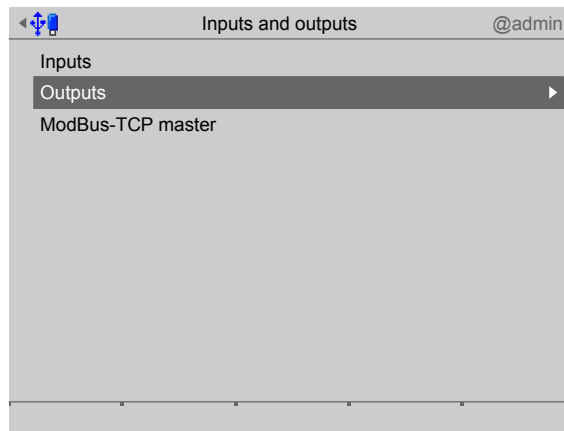

- ▶ In the operating menu, select and confirm [Configuration] - [Inputs and outputs] - [Outputs].

5.4.3.1 Analog output

The weight value of the selected weighing point is transmitted to the output.

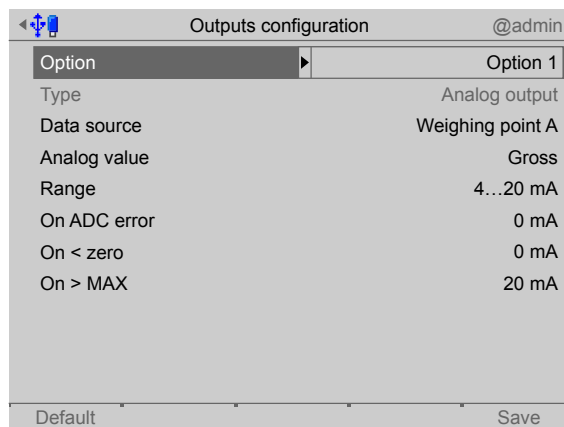

1. Select and confirm [Option] using the cursor.
 - ▷ A selection window opens.

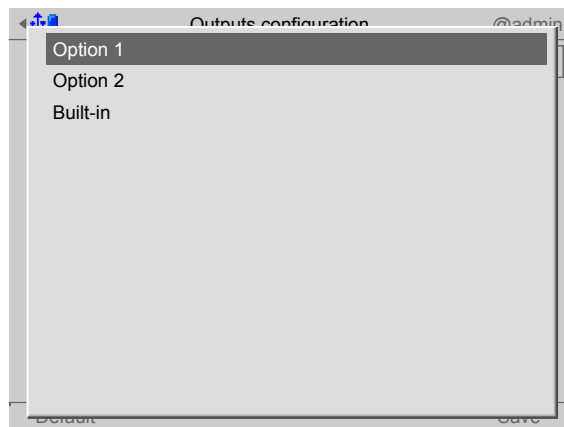

2. Select and confirm the corresponding interface using the cursor.

▷ The factory settings are displayed.

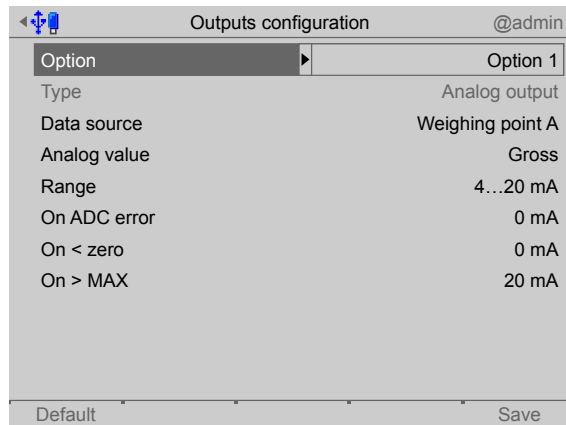

3. Configure the analog output in accordance with the table below.
4. Press the [Default] soft key to return to the factory settings, if required.
5. Press the [Save] soft key to save the settings.

Analog output

Menu item	Selection	Description
[Data source]	Weighing point A...D	Output of the weight values from scales A, B, C or D. 0...Max are converted into 0/4 mA...20 mA.
[Analog value]	Gross Net/Gross Net/0 mA Net/4 mA Net/20 mA	Output of the gross value Output of the net value, if tared; otherwise gross Output of the net value, if tared; otherwise 0 mA Output of the net value, if tared; otherwise 4 mA Output of the net value, if tared; otherwise 20 mA
[Range]	0...20 mA 4...20 mA	Output of 0...Max as 0...20 mA Output of 0...Max as 4...20 mA
[On ADC error]	0 mA 4 mA 20 mA hold	Set output to 0 mA. Set output to 4 mA. Set output to 20 mA. The last output value is held.
[On < zero]	0 mA 4 mA 20 mA hold linear	Set output to 0 mA. Set output to 4 mA. Set output to 20 mA. The last output value is held. Only for [4...20 mA]: Output goes below 4 mA until the limit is reached.
[On > Max]	0 mA 4 mA 20 mA hold linear	Set output to 0 mA. Set output to 4 mA. Set output to 20 mA. The last output value is held. Output goes below 20 mA until the limit is reached.

5.4.3.2 Adapting analog output

The analog output current on the receiving end (PLC) is generally fed through a resistor, measured as a voltage and then digitized. The output current can be adjusted in small

ranges. This is required if small deviations from the nominal value occur in a connected PLC.

Note:

Adapting the analog output, see PR 5900 operating instructions.

5.4.3.3 Digital outputs

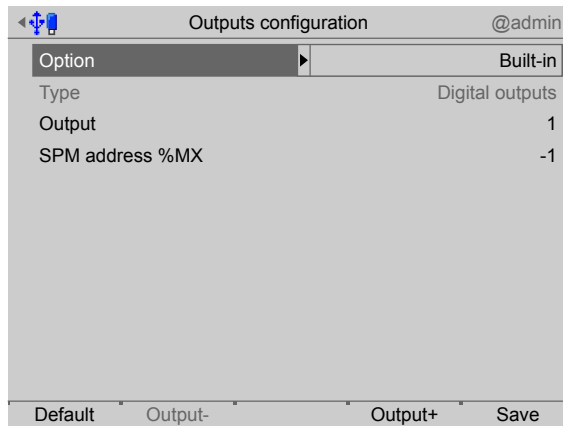

1. Select and confirm [Option] using the cursor.
 ▷ A selection window opens.

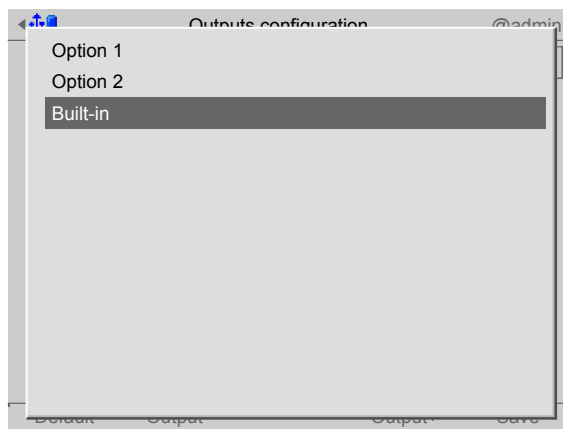

2. Select and confirm the corresponding interface using the cursor.

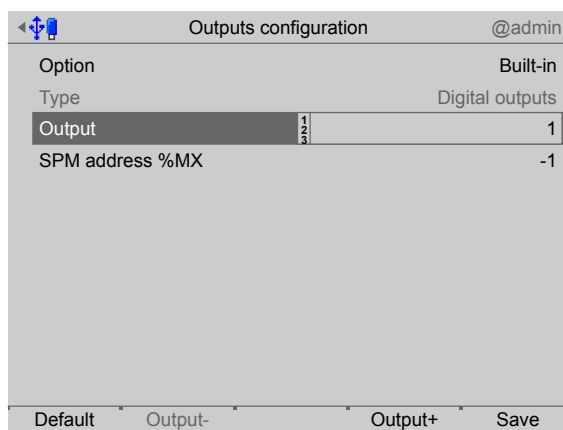

3. Select and confirm [Output] using the cursor.
4. Confirm output "1".

The screenshot shows the 'Outputs configuration' screen with the following details:

Option	Built-in
Type	Digital outputs
Output	1
SPM address %MX	4032

At the bottom of the screen, there are four soft keys: Default, Output-, Output+, and Save. The 'Output+' key is highlighted.

5. Select [SPM address %MX] using the cursor.
6. Using the keypad, enter and confirm a corresponding fixed or free address %MX (see also PR 5900 operating instructions) for the weighing point.

Note:

The SPM address %MX for an **unused** digital output = 0

A negative address inverts the function.

The screenshot shows the 'Outputs configuration' screen with the following details:

Option	Built-in
Type	Digital outputs
Output	2
SPM address %MX	-1

At the bottom of the screen, there are four soft keys: Default, Output-, Output+, and Save. The 'Output+' key is highlighted.

7. Press the [Output+] soft key to configure the next output.

The screenshot shows the 'Outputs configuration' screen with the following details:

Option	Built-in
Type	Digital outputs
Output	2
SPM address %MX	4033

At the bottom of the screen, there are four soft keys: Default, Output-, Output+, and Save. The 'Output+' key is highlighted.

8. Select [SPM address %MX] using the cursor.
9. Using the keypad, enter and confirm a corresponding fixed or free address %MX (see also PR 5900 operating instructions) for the weighing point.
10. Configure outputs 3+4 in the same way.
11. Press the [Default] soft key to return to the factory settings, if required.
12. Finally, press the [Save] soft key to save the settings.

5.4.4 I/O cards test

See PR 5900 operating instructions.

5.4.5 Configuring the ModBus TCP master

In this application, the ModBus master supports up to 8 predefined ModBus modules.

- For supported modules, see Chapter [5.4.5.1](#)
- Configuration tool, see Chapter [5.4.5.2](#)
- Device configuration, see Chapter [5.4.5.3](#)

In the operating menu, select and confirm [Configuration] - [Inputs and outputs] - [ModBus-TCP master].

5.4.5.1 Supported modules

Modules 1 - 4

Modules 1-4 relate in each case to the following module:

Phoenix Contact Inline Block IO (ILB ETH 24 DI16 DIO16-2TX)

They each offer 16 digital inputs and 16 digital outputs.

Modules 5 - 6

Modules 5-6 relate in each case to the following modules:

- Phoenix Contact Inline module (IL ETH BK DI8 DO4 2-TX-PAC)
- Phoenix Contact output module (IB IL 24 DO16-PAC)
- Phoenix Contact output module (IB IL 24 DO16-PAC)

They offer a total of 8 digital inputs and 36 digital outputs.

Modules 7 - 8

Modules 7-8 relate in each case to the following modules:

- Phoenix Contact Inline module (IL ETH BK DI8 DO4 2-TX-PAC)
- Phoenix Contact output module (IB IL 24 DO16-PAC)
- Phoenix Contact output module (IB IL 24 DO16-PAC)
- Phoenix Contact power supply (IB IL 24 PWR IN-PAC)
- Phoenix Contact output module (IB IL 24 DO16-PAC)

They offer a total of 8 digital inputs and a total of 52 digital outputs.

5.4.5.2 Configuration tool

The modules must be configured in terms of hardware according to the Phoenix instructions. In addition, an IP address must be assigned to each terminal. Phoenix provides the "IPAssign.exe" configuration tool for that purpose.

5.4.5.3 Configuration on the device

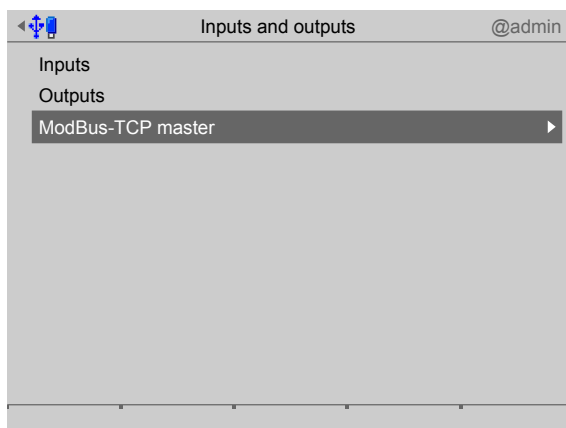

1. In the operating menu, select and confirm [Configuration] - [Inputs and outputs] - [ModBus-TCP master] .

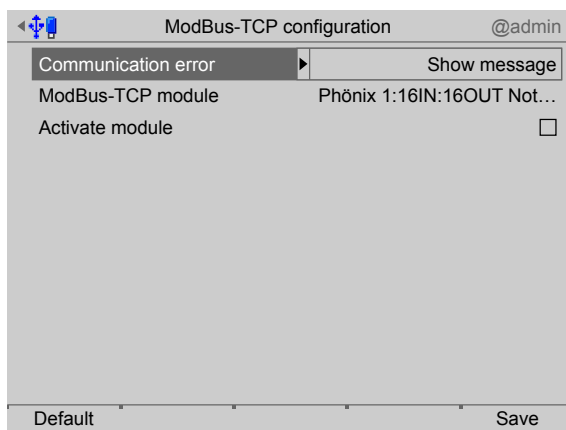

2. Select and confirm [Communication error].
 ▷ A selection window opens.

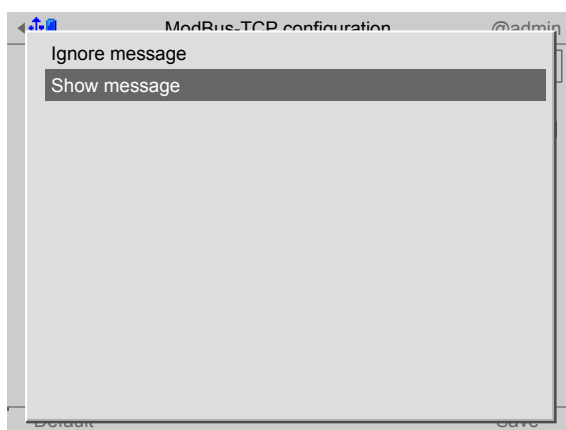

3. Select the appropriate function using the cursor (in this case, "Show message") and confirm.

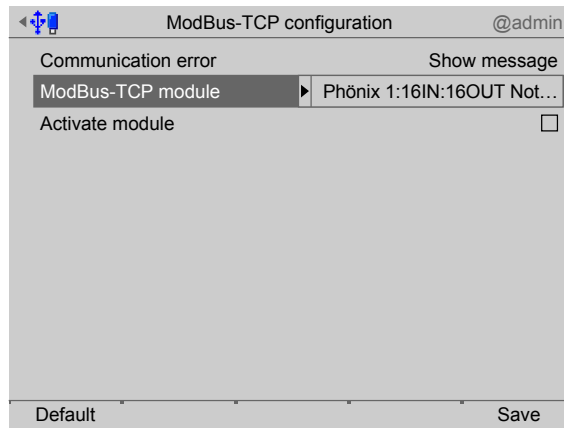

4. Select and confirm [ModBus-TCP Module] using the cursor .
 ▷ A selection window opens.

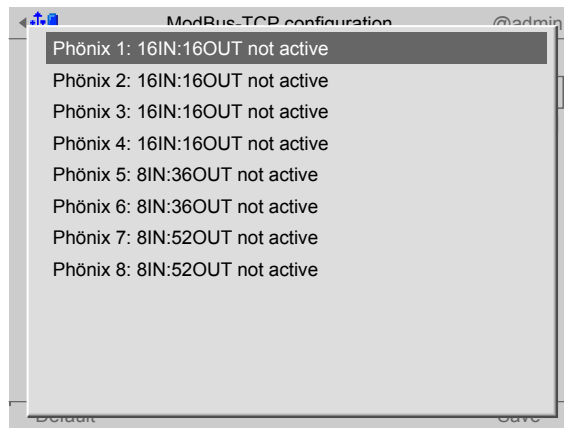

5. Select the appropriate function using the cursor (in this case, "Phoenix 1: ...") and confirm.

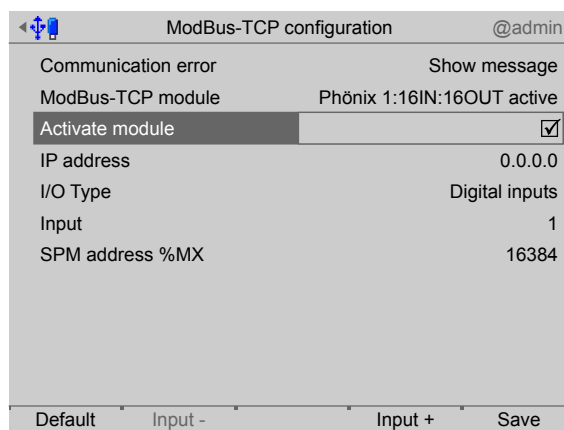

6. Check the box to activate the module.
7. Select and confirm the individual settings using the cursor.

[IP address]

Selection: speak with the responsible system administrator

[I/O type]

Selection: Digital input, Digital output

[Input/Output]

Selection: Input+ /Output+ (higher), Input- /Output- (lower)

[SPM address %MX]

Set: Fixed SPM address, see Chapter 8.

8. Press the [Default] soft key to return to the factory settings, if required.
9. Finally, press the [Save] soft key to save the settings.

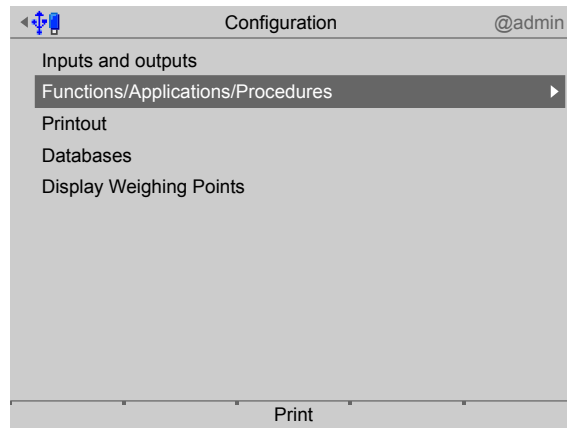
5.4.6 Configuring the weighing process

The configuration menu is displayed.

1. Select and confirm [Functions/Applications/Procedures] using the cursor.

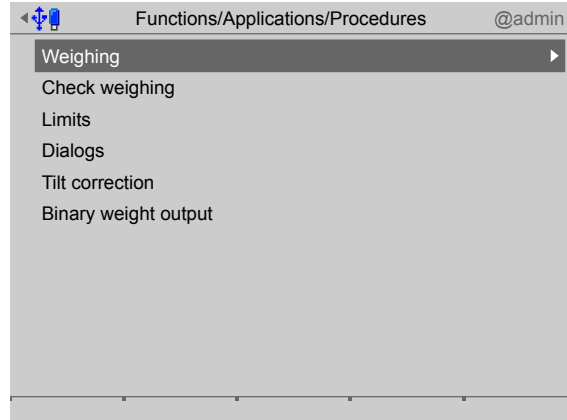

2. E.g. using the cursor select and confirm [Weighing].

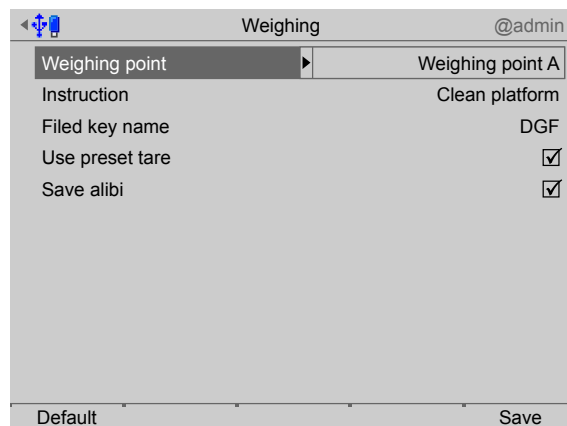

3. Select and confirm the individual settings using the cursor.

[Weighing point]

Selections: Weighing point A–D

[Instructions]

Input: Max. 20 characters via keypad

[Field key name]: e.g.: [Customer name] (here: DGF)

Selections: Database entries, see Chapter [5.4.12.3](#).

[Use preset tare]

Check the box to be able to use the preset tare when weighing. Preset tare is defined in Chapter [5.4.12.1](#).

[Save alibi]

Check the box to write the values to the Alibi memory.

Note:

"Save alibi" is disabled: SPM address = 0

"Save alibi" is not possible with a user-defined weighing point!

4. Finally, press the [Save] soft key to save the settings.

5.4.7 Configuring the checkweighing process

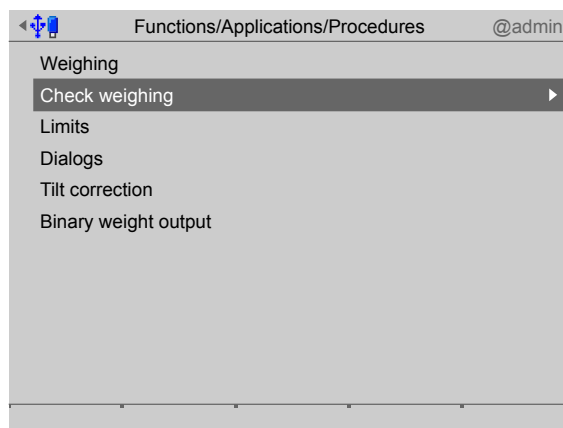

1. E.g. using the cursor select [Checkweighing] and confirm.

Check weighing		@admin
Weighing point	Weighing point A	
Instruction	Clean platform	
Field key name	DGF	
Weighing mode	Gross	
Set point display only	<input type="checkbox"/>	
Setpoint	2500.0 g	
Setpoint min.	2490.0 g	
Setpoint max.	2510.0 g	
Save alibi	<input checked="" type="checkbox"/>	
Show dialogs before printing	<input checked="" type="checkbox"/>	
Default	Save	

2. Select and confirm the individual settings using the cursor.

[Weighing point]

Selections: Weighing point A–D

[Instructions]

Input: Max. 20 characters via keypad

[Field key name]: e.g.: [Customer name] (here: DGF)

Selections: Database entries, see Chapter [5.4.12.3](#).

[Weighing mode]

Selections: Gross, net

[Only display set point]

Check the box to display only the set point. This means it is no longer possible to change the set points.

[Set point]

Input: Weight value via keyboard

[Set point min.]

Input: Weight value via keyboard

[Set point max.]

Input: Weight value via keyboard

[Save alibi]

Check the box to write the values to the Alibi memory.

Note:

"Save alibi" is disabled: SPM address = 0

"Save alibi" is not possible with a user-defined weighing point!

[Show dialogs before printing]

Check the box to display the dialog before printing. This function is only possible if printing is initiated by the **START** key. Define dialogs, see Chapter [5.4.9](#).

3. Finally, press the [Save] soft key to save the settings.

5.4.8 Limit values: configuration

Each limit consists of a switch-on and a switch-off point for definition of a hysteresis. The 3 pairs of values must be entered according to the same principle. The limit values always refer to the gross weight.

For the SPM addresses for the limits, see Chapter 8.

Example 1:

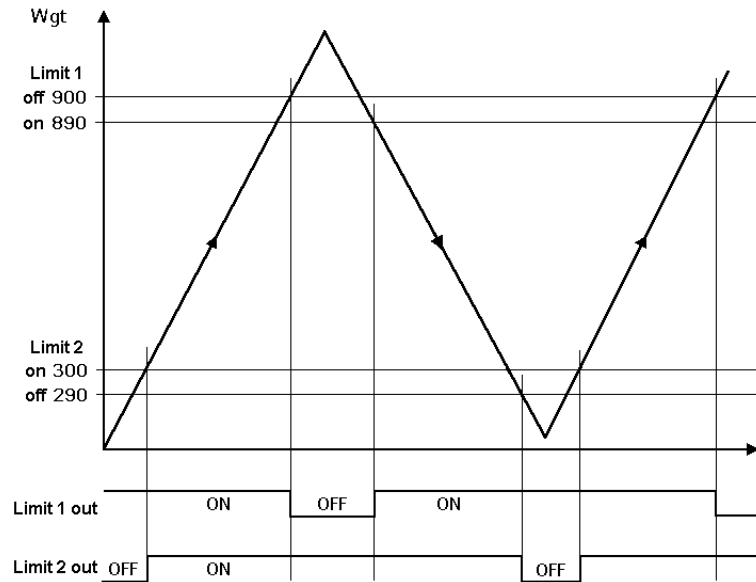

The output signal (Limit 1 out) of limit 1 switches OFF above a weight (Wgt) of 900 g.

The output signal (Limit 2 out) of Limit 2 switches OFF below 290 g.

The two limit values have a hysteresis of 10 g.

In the event of a power failure both outputs turn to "off" ("OFF"), thus indicating underfill and overfill simultaneously.

Example 2:

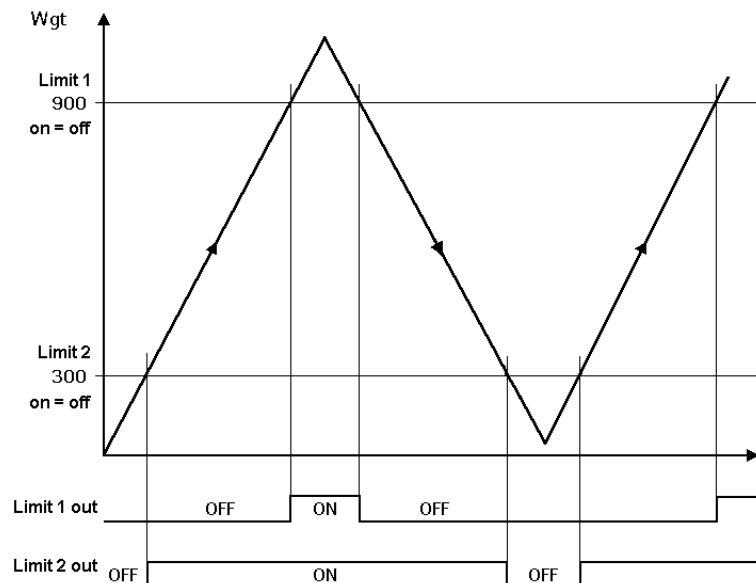

If the Limits 1 and 2 are the same for "On" and "Off" (on = off),

- switches output 1 (Limit 1 out) ON if the weight (Wgt) exceeds the value.

- switches output 2 (Limit 2 out) OFF if the weight falls below the value.

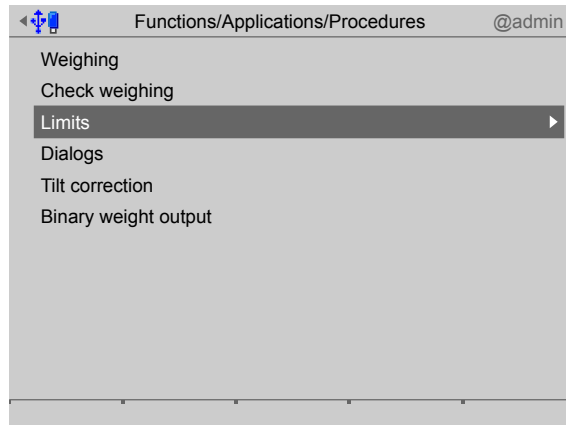

1. Select and confirm [Limits] using the cursor.

Select weighing point

The screenshot shows the 'Limits' configuration screen with a table of settings. The top of the screen shows navigation icons and the text 'Limits @admin'. The table has the following data:

Weighing point		Weighing point A
Limit1On		890.0 g
	Action1On	None
	Condition1On	No condition
Limit1Off		900.0 g
	Action1Off	None
	Condition1Off	No condition
Limit2On		300.0 g
	Action2On	None
	Condition2On	No condition
Limit2Off		290.0 g
Default		Save

2. Select and confirm [Weighing point] using the cursor.

▷ A selection window opens.

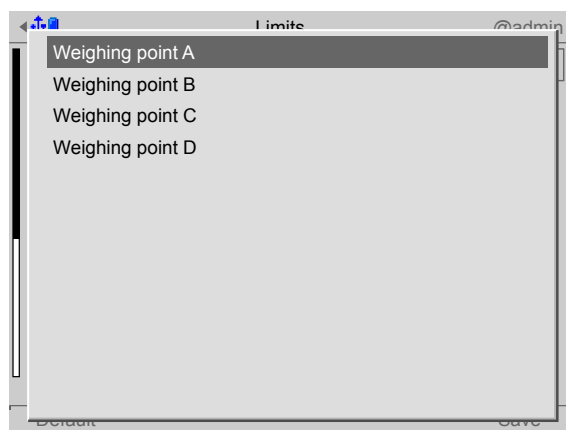

3. Select and confirm the appropriate weighing point using the cursor.

Set limit values according to example 1

Limits		@admin
Weighing point		Weighing point A
Limit1On	1 2 3	890.0 g
	Action1On	None
	Condition1On	No condition
Limit1Off		900.0 g
	Action1Off	None
	Condition1Off	No condition
Limit2On		300.0 g
	Action2On	None
	Condition2On	No condition
Limit2Off		290.0 g
Default		Save

4. Using the cursor, select appropriate lines.
5. Use the keyboard to enter and confirm the desired values (in this case: see example 1).
6. Press the [Default] soft key to return to the factory settings, if required.

Set action

Markers can be set for all limits (in this case, see Example 2):

Limits		@admin
Weighing point		Weighing point A
Limit1On		900.0 g
	Action1On	None
	Condition1On	No condition
Limit1Off		900.0 g
	Action1Off	None
	Condition1Off	No condition
Limit2On		300.0 g
	Action2On	None
	Condition2On	No condition
Limit2Off		300.0 g
Default		Save

7. Mark and confirm the action line of the corresponding limit.
 - ▷ A selection window opens.

Limits		@admin
		None
		Set marker 1
		Set marker 2
		Set marker 3
		Clear marker 1
		Clear marker 2
		Clear marker 3
Default		Save

8. Select and confirm the appropriate line to set the marker for Limit 1 (in this case, Marker 1 is set when 900 g is exceeded).

9. If applicable, set other markers.

Set condition

Limits		@admin
Weighing point	Weighing point A	
Limit1On	900.0 g	
	Action1On	None
	Condition1On	No condition
Limit1Off	900.0 g	
	Action1Off	None
	Condition1Off	No condition
Limit2On	300.0 g	
	Action2On	None
	Condition2On	No condition
Limit2Off	300.0 g	
Default	Save	

10. Highlight and confirm the condition line of the appropriate limit using the cursor.

▷ A selection window opens.

Limits		@admin
Center zero not active		
Within zero set range not active		
Standstill Not active		
Dimmed Not active		
Internal error: command error Not active		
Command busy Not active		
Power fail Not active		
Test active Not active		
Calibration active Not active		
Tare active Not active		
Marker bit 1 Not active		
Marker bit 2 Not active		
Default	Save	

11. Select and confirm the appropriate line.
 12. If applicable, select additional conditions for the other limits.

Saving settings

Limits		@admin
Weighing point	Weighing point A	
Limit1On	900.0 g	
	Action1On	None
	Condition1On	Standstill Not active
Limit1Off	900.0 g	
	Action1Off	None
	Condition1Off	No condition
Limit2On	300.0 g	
	Action2On	None
	Condition2On	No condition
Limit2Off	300.0 g	
Default	Save	

13. Finally, press the [Save] soft key to save the settings.

5.4.9 Configuring dialogs

Dialogs consist of messages that appear on screen after pressing the START key and require the corresponding input and confirmation. The dialog can then be printed out, if the printout is configured accordingly, see Chapter 5.4.11.

10 dialog messages can be configured.

If no dialog messages have been entered, no message is displayed/no input is expected.

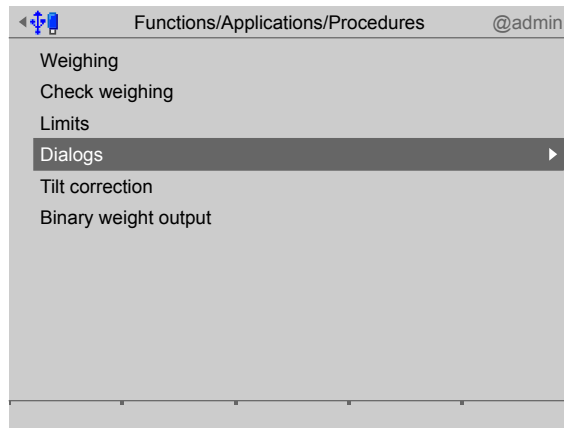

1. Select and confirm [Dialogs] using the cursor.

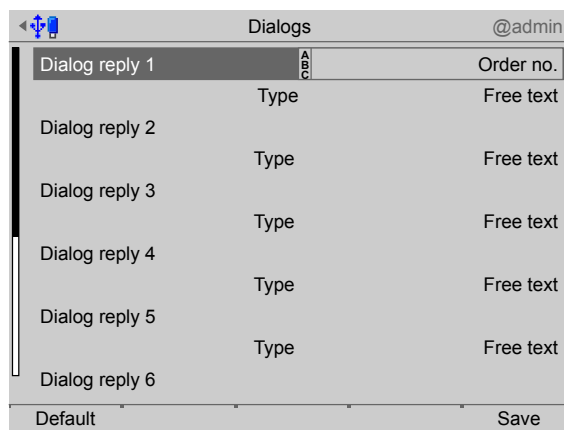

2. Select the relevant line using the cursor.
3. Use the keypad to enter and confirm the dialog message.

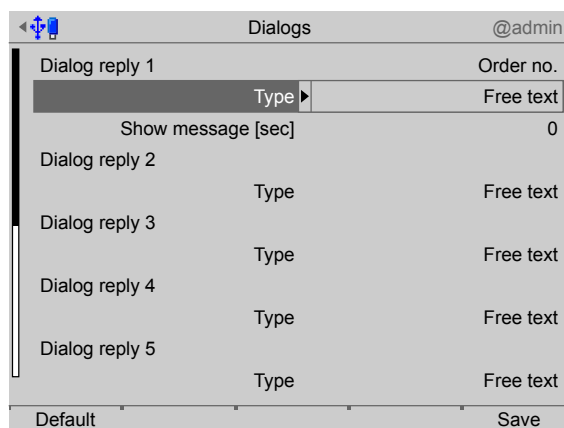

4. Select and confirm the line "Type" using the cursor.
5. For example, if the "Free text with timeout" type is selected, another line appears.

6. Use the keypad to enter and confirm the display duration of the message.
 - ▷ A selection window is displayed.

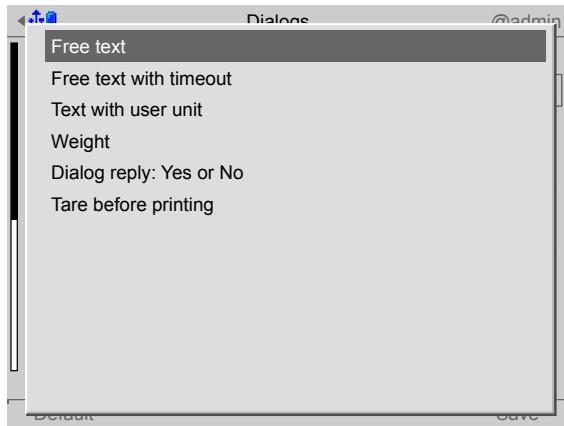

7. Select and confirm the appropriate line.

[Free text without timeout]

The dialog message appears and can only be hidden by the operator.

[Free text with timeout]

The dialog message is displayed for a defined period and then disappears without any action by the operator.

[Text with user-defined unit]

The dialog message appears with the user-defined unit (e.g.: pcs, °C, etc.) and can only be hidden by the operator.

[Weight]

The current weight value of the corresponding weighing point is displayed and can only be hidden by the operator.

[Reply from dialog: Yes or No]

The dialog message appears and can only be hidden by the operator.

[Tare before printing]

The dialog message appears and can only be hidden by the operator.

8. Finally, press the [Save] soft key to save the settings.

5.4.10 Configuring binary weight output

With binary weight output, the current gross weight output of a weighing point will be given as a 12 bit binary weight (max. 4095).

This allows 12 digital outputs to be connected. The outputs are configured via fixed SPM addresses, see Chapter 8.

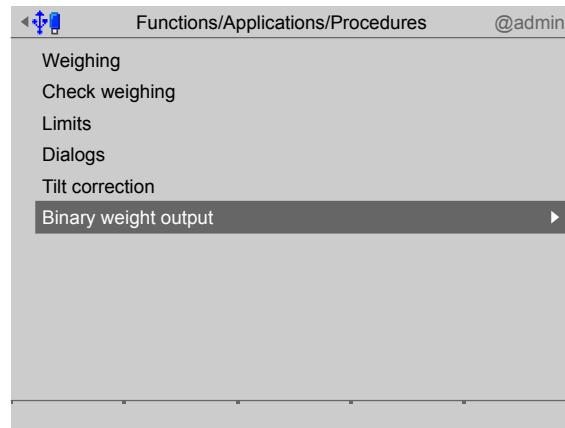

1. Select and confirm [Binary weight output] using the cursor.

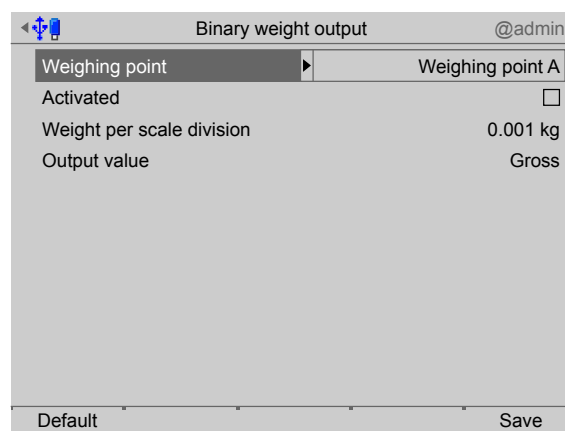

2. Select and confirm [Weighing point] using the cursor.
▷ A selection window opens.

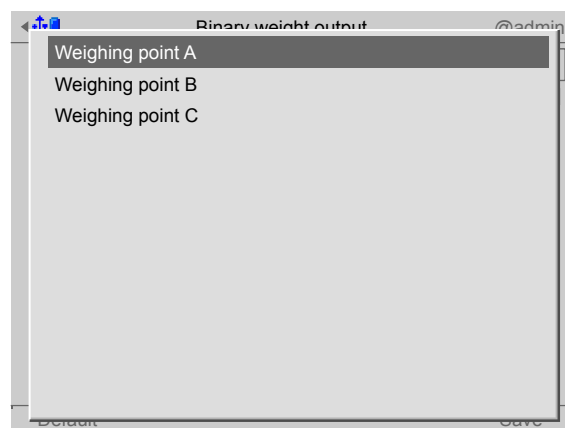

3. Select and confirm the appropriate weighing point using the cursor.

Binary weight output		@admin
Weighing point	Weighing point A	
Activated	<input checked="" type="checkbox"/>	
Weight per scale division	0.001 kg	
Output value	Gross	
Default		Save

4. Check the box to activate the binary weight output for the corresponding weighing point.

Binary weight output		@admin
Weighing point	Weighing point A	
Activated	<input checked="" type="checkbox"/>	
Weight per scale division	0.001 kg	
Output value	Gross	
Default		Save

5. Input the weight per count value. This value corresponds to the weight to which the binary output will be scaled.

Binary weight output		@admin
Weighing point	Weighing point A	
Activated	<input checked="" type="checkbox"/>	
Weight per scale division	0.001 kg	
Output value	Gross	
Default		Save

6. Select and confirm [Output value] using the cursor.
 ▷ A selection window opens.



7. Select and confirm the appropriate line.
8. Finally, press the [Save] softkey to save the settings.

5.4.11 Configuring printout

This function is required to configure the weighing and checkweighing log.

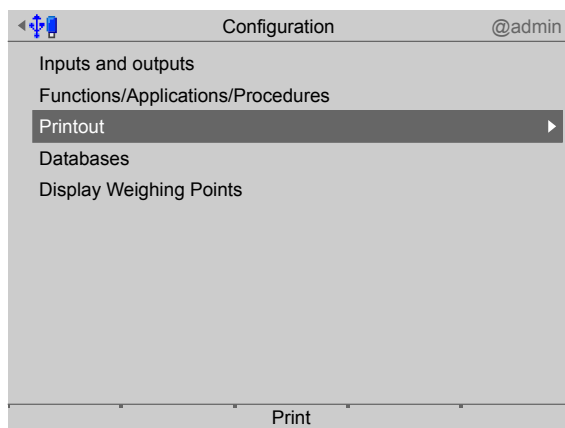

1. Select and confirm [Printout] using the cursor.

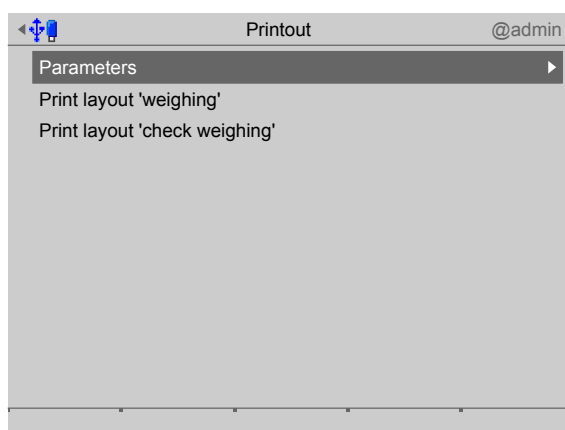

2. Select and confirm [Parameters] using the cursor.
 - ▷ A selection window is displayed.

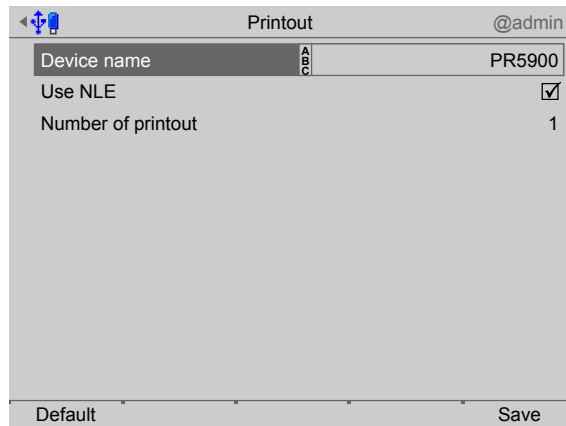

3. Select and confirm the individual settings using the cursor.

[Device name]

Input: Max. 20 characters via keypad

[Use NLE]

Check the box to use NLE (NiceLabelExpress) for the design of printouts, see also Chapter [10.3.3](#).

[Number of printouts]

Input: Figures via keyboard

4. Finally, press the [Save] soft key to save the settings.

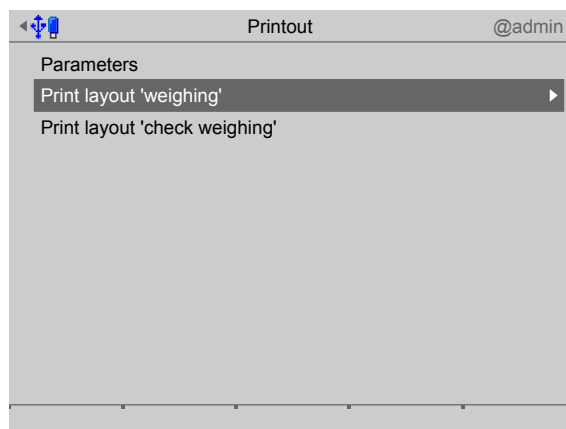

5. Select and confirm [Print layout "Weighing"] using the cursor.
 - ▷ A selection window is displayed.

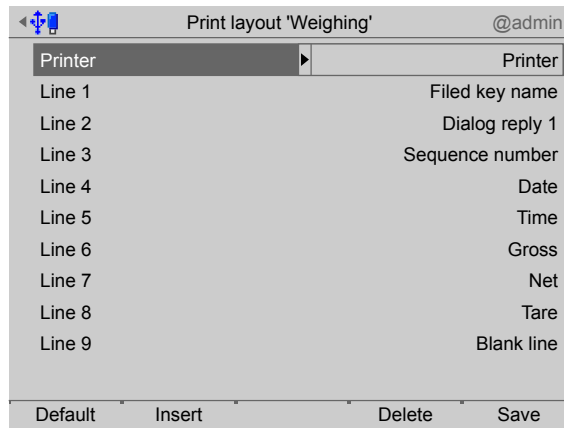

6. Press the [Insert] soft key to insert a new line below the highlighted line. Up to 99 lines can be defined.
7. Press the [Delete] soft key to delete the highlighted line.
8. Select and confirm the individual settings using the cursor.

[Printer]

Selection: none, printer, ticket printer, printer 2

This requires previous setup in the system menu under [System setup]- [Connected devices]

[Line 199]

Selections: Blank line, -----, Form feed, Device name, Weighing point, Sequence number, Date, Time, Gross, Net, Tare, Header, Weighing mode; Dialog reply 1–10, Free number 1–3, Entered. weight, Entered string, Edited int, Edited real, Field key name, Field name 16

9. Finally, press the [Save] soft key to save the settings.

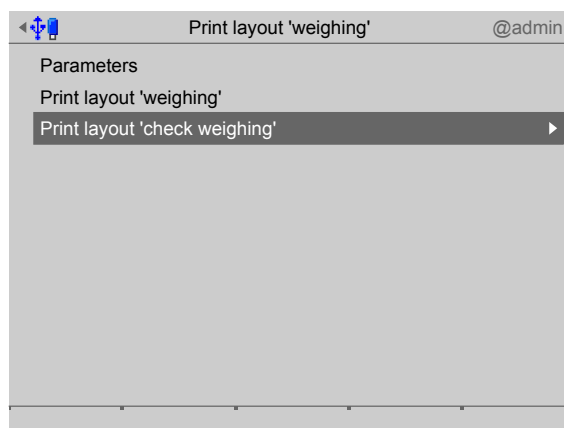

10. Select and confirm [Print layout "Checkweighing"] using the cursor.
 - ▷ A selection window is displayed.

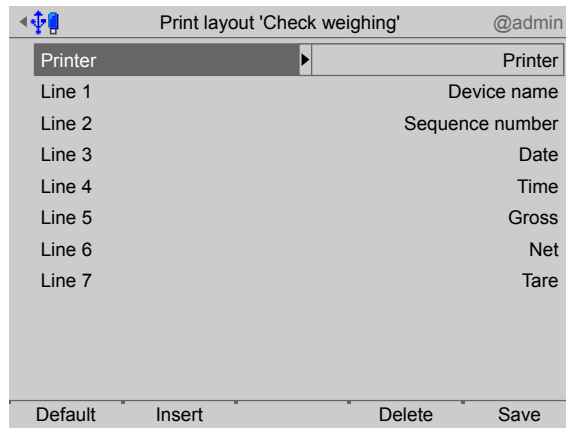

11. Press the [Insert] soft key to insert a new line below the highlighted line. Up to 99 lines can be defined.
12. Press the [Delete] soft key to delete the highlighted line.
13. Select and confirm the individual settings using the cursor.

[Printer]

Selection: none, printer, ticket printer, printer 2

This requires previous setup in the system menu under [System setup]- [Connected devices]

[Line 199]

Selections: Blank line, -----, Form feed, Device name, Weighing point, Sequence number, Date, Time, Gross, Net, Tare, Header, Weighing mode; Dialog reply 1–10, Free number 1–3, Entered. weight, Entered string, Edited int, Edited real, Field key name, Field name 16

14. Finally, press the [Save] soft key to save the settings.

5.4.12 Configuring databases

The following databases are available in this application:

- Tare specifications, see Chapter [5.4.12.1](#)
- Predefined texts for the terminal function, see Chapter [5.4.12.2](#)
- Application database, see Chapter [5.4.12.3](#)

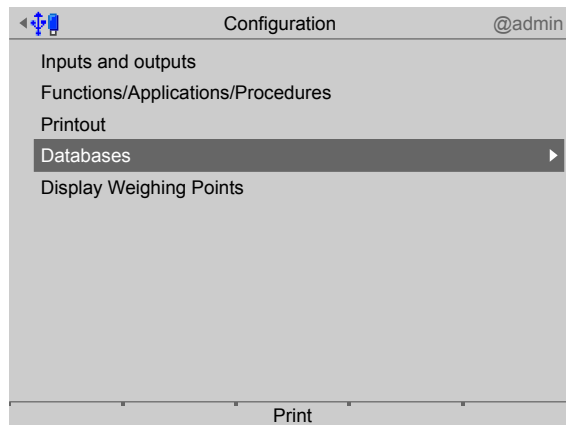

- ▶ Select and confirm [Databases] using the cursor.

5.4.12.1 Creating/Changing/Deleting preset tares

Preset tares can be saved in this database and assigned to each weighing point.

If an ID already exists, you can use [Change] to modify the associated names and weights.

The tare name is freely selectable and can appear several times. The tare weight unit can be selected. If the scale and the tare are using different units, the preset tare value will be converted to the scale unit during taring.

A preset tare value may not be greater than the largest Max of a scale.

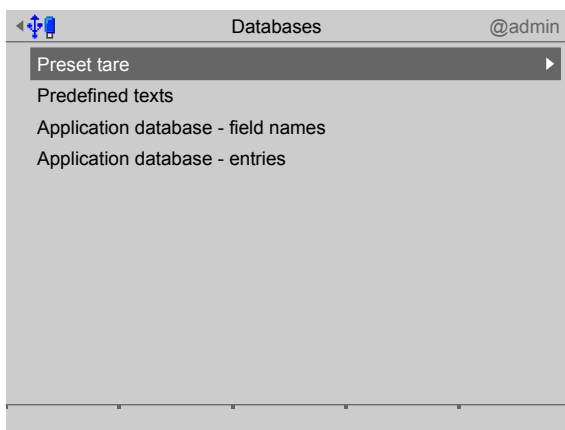

1. Select and confirm [Preset tare] using the cursor.

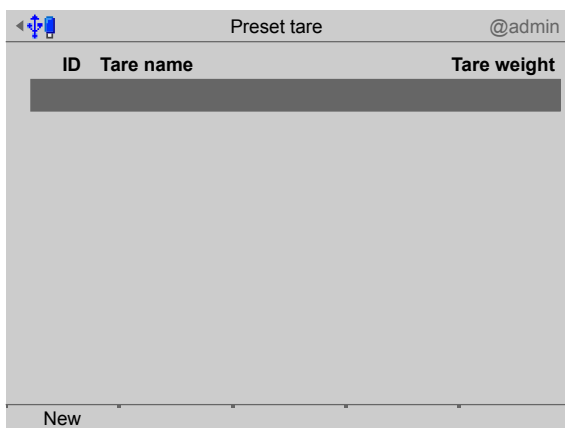

2. Press the [New] soft key to create a new record.
 ▷ A selection window is displayed.

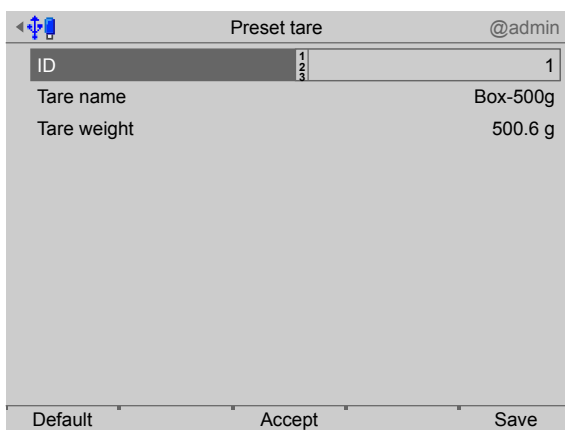

3. Select and confirm the individual settings using the cursor.

[ID]

Input: Automatic numbering or manual numbering via the keyboard from 1–999

[Tare name]

Input: Max. 20 characters via keypad

[Tare weight]

Position the appropriate weight and press the [Accept] soft key.

4. Finally, press the [Save] soft key to save the parameters in the database.

ID	Tare name	Tare weight
1	Box-500g	500.6 g
2	Box-22g	22.4 g

New Change Delete

5. If applicable, press the [Change] soft key to change the highlighted record.
6. If applicable, press the [Delete] soft key to delete the highlighted record.

5.4.12.2 Creating predefined texts

Predefined texts can be saved in this database. These texts are required for the terminal function. The predefined texts can be displayed via fieldbus or OPC. At least one text must be entered for line 1, see also Chapter 6.5.

If an ID already exists, you can use [Change] to modify the associated texts.

Databases
Preset tare
Predefined texts ▶
Application database - field names
Application database - entries

1. Select and confirm [Predefined texts] using the cursor.

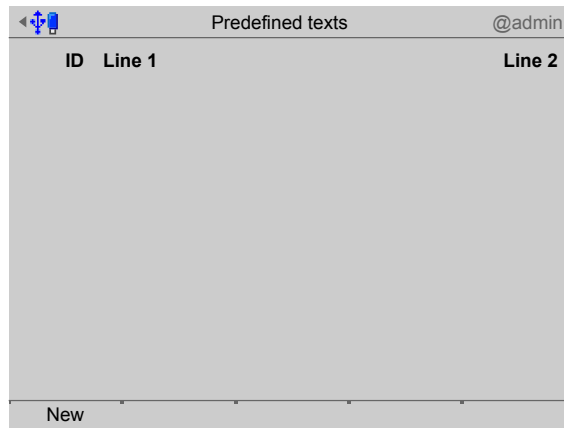

2. Press the [New] soft key to create a new record.
 ▷ A selection window is displayed.

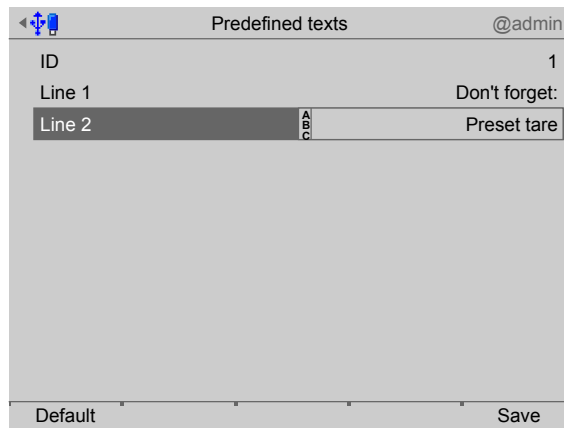

3. Select and confirm the individual settings using the cursor.

[ID]

Input: Automatic numbering or manual numbering via the keyboard from 1–999

[Line 1]

Input: Max. 20 characters via keypad

[Line 2]

Input: Max. 20 characters via keypad.

4. Finally, press the [Save] soft key to save the parameters in the database.

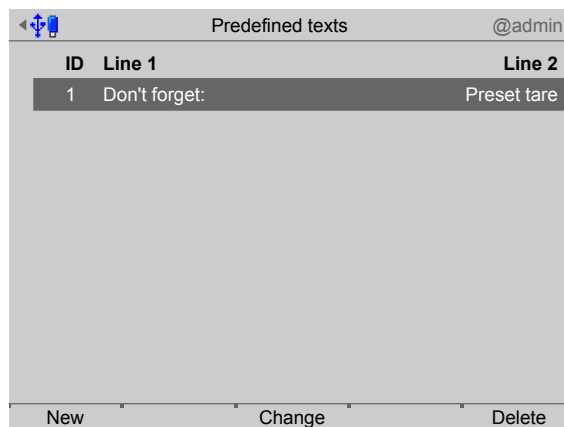

5. If applicable, press the [Change] soft key to change the highlighted record.
6. If applicable, press the [Delete] soft key to delete the highlighted record.

5.4.12.3 Application database

Only one application database can be created in each case (e.g.: customer database **or** materials database **or** recipe database).

Defining field names

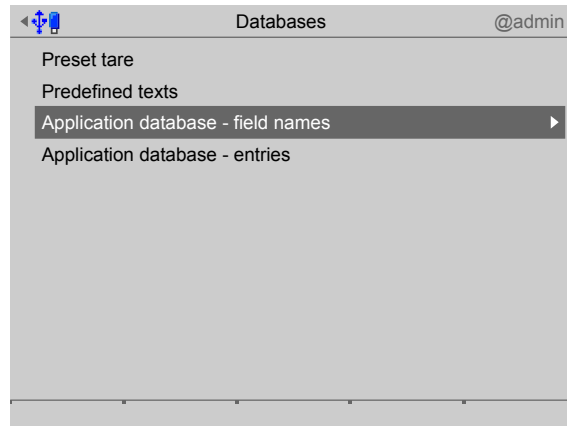

1. Select and confirm [Application database - Field names] using the cursor.

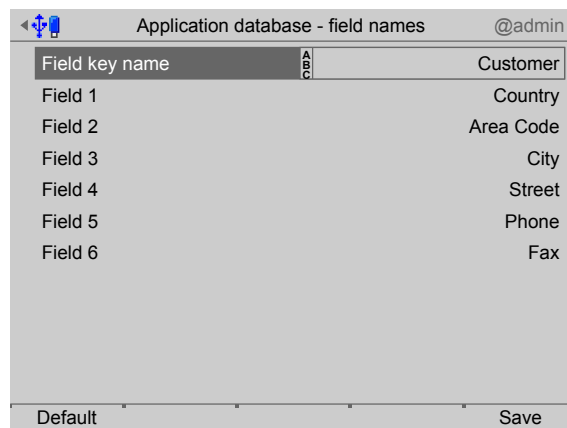

2. Select and confirm the individual lines using the cursor.

[Field key name]

Entering the database name: Max. 20 characters via keyboard (in this case: Customer)

[Field name 1–6]

Input: Max. 20 characters via keypad

3. Finally, press the [Save] soft key to save the parameters in the database.

Changing/Deleting/Creating database entries

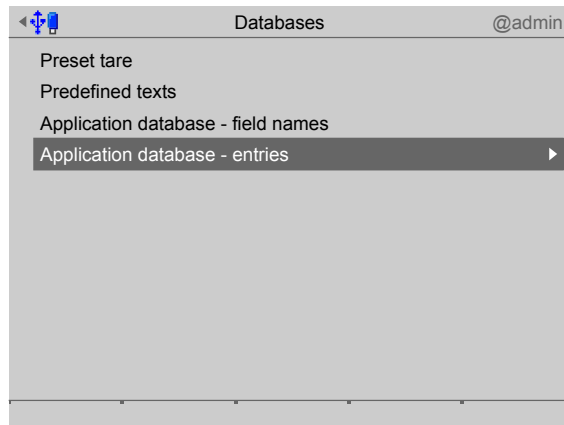

4. Select and confirm [Application database - Entries] using the cursor.

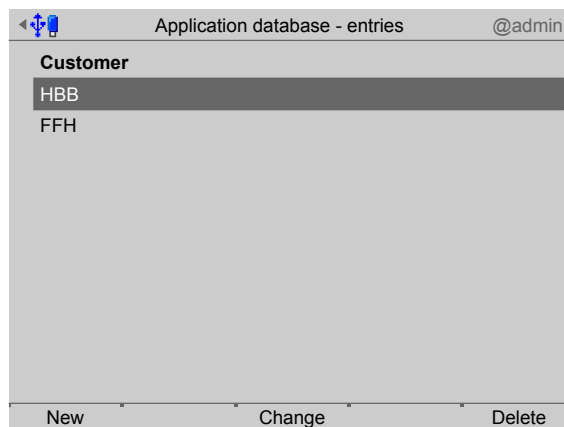

5. Press the [New] soft key to create a new database entry.
6. If applicable, press the [Change] soft key to change the highlighted record.
7. If applicable, press the [Delete] soft key to delete the highlighted record.

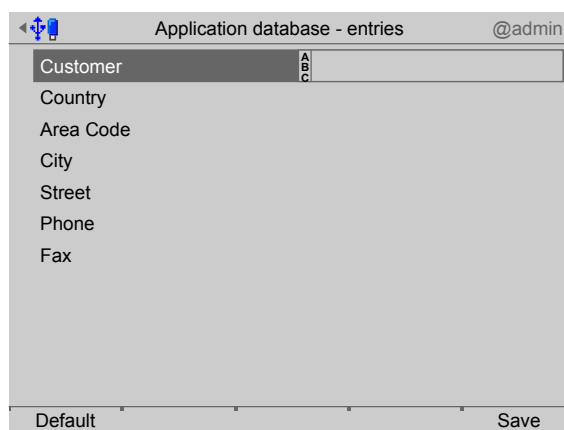

8. Use the cursor to select the individual lines, enter max. 20 characters using the keyboard and confirm.
9. Finally, press the [Save] soft key to save the parameters in the database.

5.4.13 Displaying weighing points

This function is required to configure the production display.

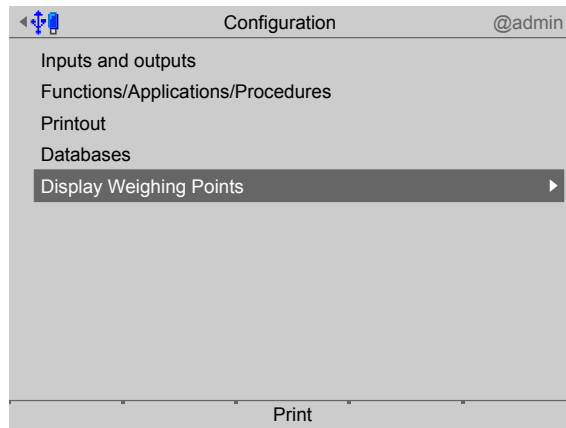

1. Select and confirm [Display weighing points] using the cursor.
 ▷ A selection window is displayed.

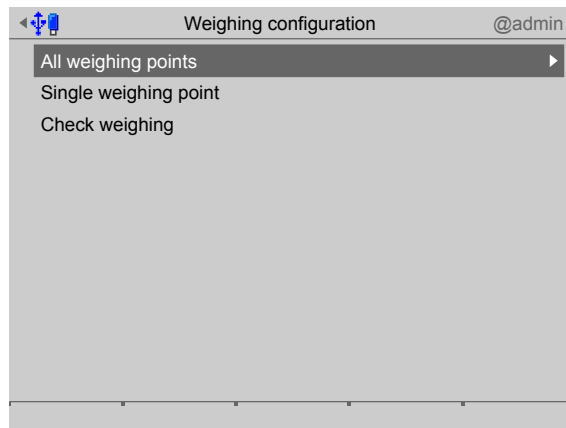

2. Select and confirm the individual settings using the cursor.

[All weighing points]

Check the box to show an overview of all weighing points.

Selections: Gross, Net, Tare, Limit 1–3, Analog output 1+2, Field key name, Blank line

[Single weighing point]

Each weighing point is shown individually.

Selections: Gross, Net, Tare, Limit 1–3, Analog output 1+2, Field key name, Field 1–6

[Checkweighing]

Each weighing point is shown individually.

Selection: Gross, Net, Tare, Limit 1–3, Analog output 1+2, Field key name, Field 1–6

5.4.13.1 Example: Checkweighing

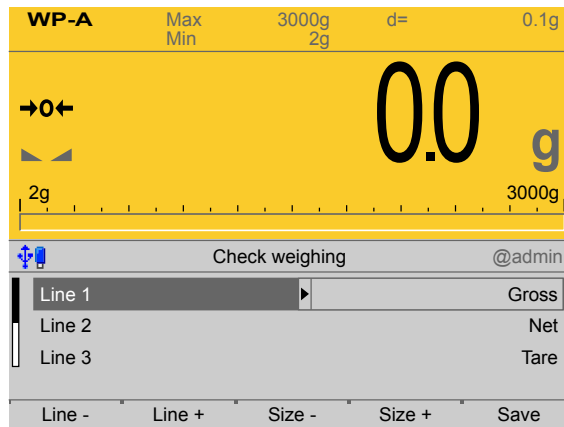

1. Press the [Line +] soft key to add a line. A maximum of 8 lines are possible. If more lines are defined than there is space available (depending on the selected size), you can scroll through the lines on the display.
2. If applicable, press the [Line -] soft key to delete a line.
3. Press the [Size -] or [Size +] soft key to reduce or increase the size of the weight display (5 increments). The default setting is 4 (3 lines can be displayed simultaneously).
 Setting 1 produces the smallest weight display: 5 lines can be displayed simultaneously.
 Setting 5 produces the largest weight display: only one line can be displayed.
4. Finally, press the [Save] soft key to save the settings.

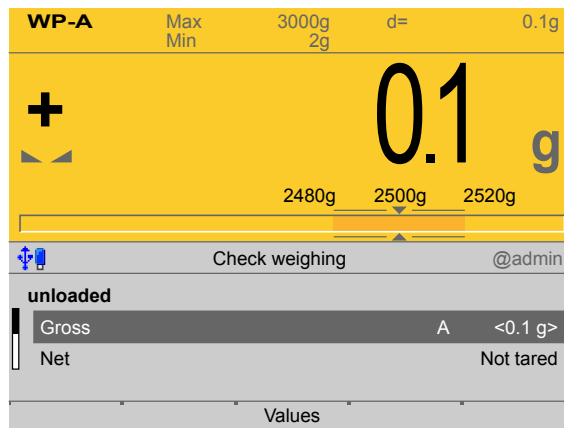

Here is an example of a configured scale display.

5.5 Switching off the device

This function is required to disconnect the device from the power immediately, e.g., to install an option card. The rechargeable battery is immediately deactivated.

Note:

With a menu-driven shutdown, not all the content of the SD-RAM will be saved to a NAND flash memory.

When restarting, a cold start is forced. For example, database entries **no longer** exist.

It is recommended to first make a backup on the SD card and/or export the data to a USB stick; see Chapter PR 5900 operating instructions.

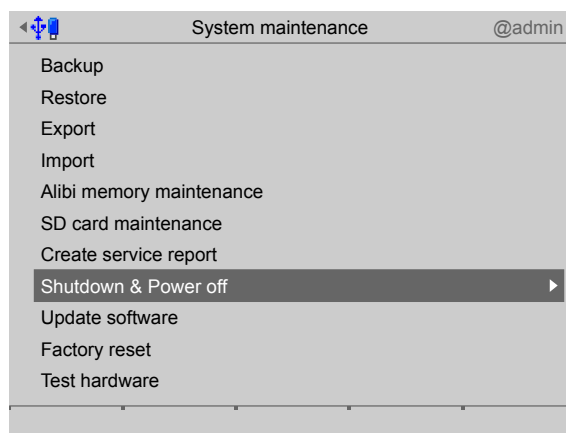

1. In the operating menu, select and confirm [System maintenance] - [Shutdown & Power off].

▷ A prompt window opens.

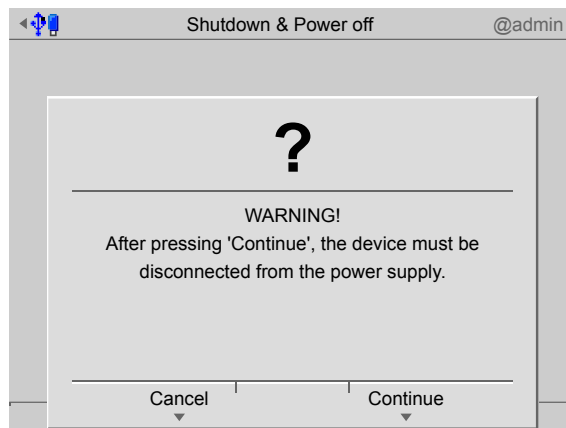

2. Press the [Next] soft key.
3. Disconnect the power plug.

6 Applications

6.1 General notes

Operation takes place via the application menu, see also Chapter 4.

The following functions are available:

- For weighing, see Chapter 6.3
- For check weighing, see Chapter 6.4
- For terminal function, see Chapter 6.5

6.2 Alibi memory

The Alibi memory requires a license number, which must be entered into the device under [System setup] - [License settings].

Note:

It is not possible to write the values of the user-defined weighing point into the Alibi memory!

A data set is created for each weight value. This means that 3 sets are saved with identical sequence number, if gross weight, net weight, and tare are saved at a particular time.

The gross weight is saved with all weighing operations.

The following functions are possible:

- For searching the Alibi memory via website, see the PR 5900 operating instructions.
- For browsing the Alibi memory using the [System information] - [Browse Alibi memory], please see PR 5900 operating instructions.
- For deleting the Alibi memory using the [System setup] - [Alibi memory], please see PR 5900 operating instructions.

6.3 Weighing

The configuration of the scale display is performed in the [Configuration] - [Display Weighing Points] menu, see Chapter 5.4.6.

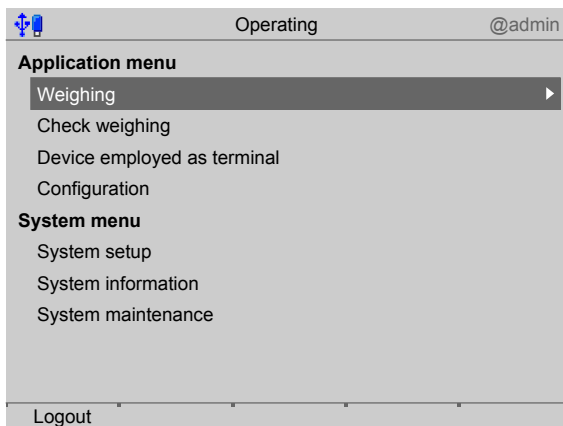

1. Select and confirm [Weighing] using the cursor.

- ▷ The scale display appears (in this case, single weighing point).

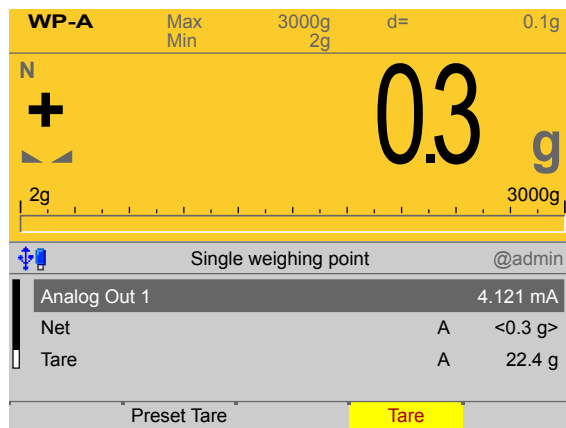

- If applicable, press the [Preset tare] soft key to select the appropriate preset tare, see Chapter 5.4.6 and Chapter 5.4.12.1.
- Perform the weighing process.
- Press the **START** key (with show dialogs before printing) or the  key to initiate printing.
 - ▷ Depending on the configuration, the values are written to the Alibi memory (see PR 5900 operating instructions) and/or printed out, see Chapter 5.4.6, 5.4.9, 5.4.11 and 10.3.

6.4 Checkweighing

The configuration of the scale display is performed in the [Configuration] - [Display Weighing Points] menu, see Chapter 5.4.13.

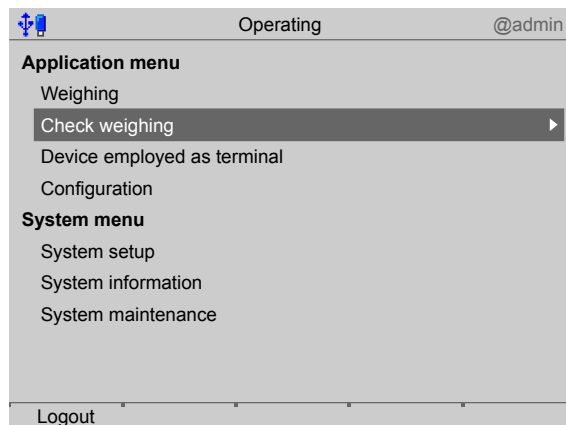

- Select and confirm [Checkweighing] using the cursor.

Checkweighing requirements

- Prior to positioning the weight, the scale is in the “unloaded” state, i.e. < min. weight.
 - After positioning the weight, the scale is in the “loaded” state, i.e. > min. weight and has achieved a standstill.
- ▷ The checkweigher display appears.

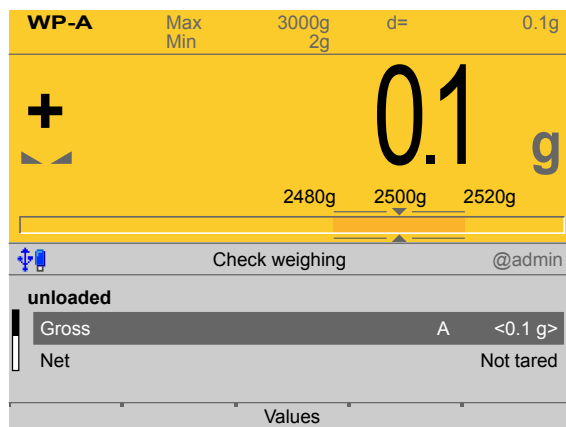

2. If applicable, press the [Values] soft key to change the set points and tolerances.
3. Perform the checkweighing process.
 - ▷ Depending on the configuration, the values are written to the Alibi memory (see PR 5900 operating instructions) and/or printed out, see Chapter [5.4.7](#), [5.4.9](#), [5.4.11](#) and [10.3](#).

6.5 Terminal function

6.5.1 General

The terminal function (selection in the application menu: menu item "Device employed as terminal"), can be used to remotely control the display via the communication network. The operator's keystrokes can be read back.

To simplify the remote control, texts, numbers and weight values can be edited on the device. Only the final result needs to be outputted.

All texts can also be saved locally in the device and can be retrieved using a text number.

The terminal function can be canceled at any time with the **EXIT** key or "termfun" = -1 (even if a dialog is open). A question appears.

6.5.2 Control unit

Terminal functions are controlled by two variables:

- termfun
- termstat

These variables can be read and written via DDE/OPC (see Chapter [8](#)) or via fieldbus (see Chapter [7](#)).

termfun	specifies the function which is to be executed (MD 95 for WP A, see Chapter 8 or fieldbus address 225 - write).
0	no function
1...	Execute function
-1	Cancel function, equivalent to the EXIT key

termstat	returns to the execution status (MD 96 for WP A, see Chapter 8 or fieldbus address 219 - read)
0	Terminal idle
1, ...	Function ended
-1	Terminal busy
-2	General error
-3	Unknown text number (database)

The functions obtain your input texts for "Line 1" (the top display line) and for "Line 2" (the bottom display line) from the variables "dsp1" or "dsp2".

If the text number $N * 256$ is added to the function number (in "termfun"), "dsp1" and "dsp2" are taken from the table of predefined texts.

The general procedure between the communication master (PC or fieldbus master) and the communication slave (device) is described in the following table.

Master	Slave
	After initialization, the variables "termfun" and "termstat" are set to 0. The device is ready to execute a function.
Writes text to the variables "dsp1" and "dsp2".	Has no effect.
Writes the function number (e.g. 2) to "termfun". Waits until the status variable "termstat" is > 0.	Sets the "termstat" status to -1 (busy). The predefined function (in this case: No 2) is executed: <ul style="list-style-type: none"> - Displays the text of "dsp1" in line 1. - Displays the text of "dsp2" in line 2 and allows "dsp2" to be edited by the operator in line 2.
	User presses the OK key to complete the editing.
	Writes input to "dsp2". Sets "termstat" to 1 (OK, dialog is closed). Waits until "termfun" has been reset to "0".
Reads "termstat" = 1 Reads input text from "dsp2"	Has no effect.
Writes function "0" to "termfun".	Sets "termstat" to "0" (idle) and is then ready for a new function. The 2-line text display is empty once again.

6.5.3 Predefined functions

- Display function, see Chapter [6.5.3.1](#)
- Input functions, see Chapter [6.5.3.2](#)
- Message functions, see Chapter [6.5.3.3](#)

In addition to the basic terminal functionality, it is possible to enter a value or a text locally on the device or to output messages using predefined functions.

This is controlled by setting the "Function type" parameter to "termfun".

6.5.3.1 Display function

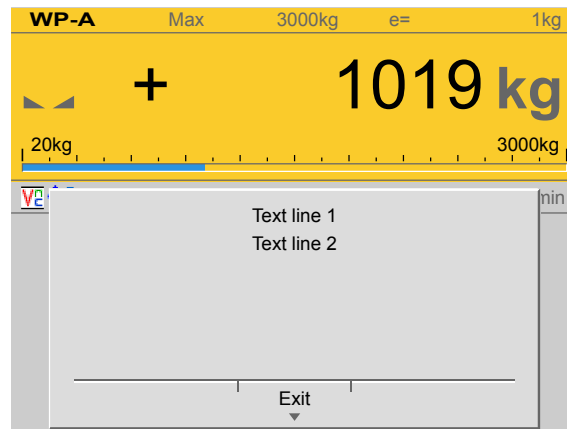

"termfun" = 1: text display

Texts in line 1 and line 2 are constantly updated. The content of memory cell "dsp1" is copied to line 1, and that of memory cell "dsp2" to line 2. The function can be terminated via "termfun" = -1 or with the **EXIT** key.

termstat = 2 after pressing the [Exit] softkey or pressing the **EXIT** key.

6.5.3.2 Input functions

The text content of memory cell "dsp1" is displayed in the top line. In the case of numerical input, the text content of memory cell "dsp2" is displayed after the number as a unit.

Spaces before the first character and after the last character are truncated.

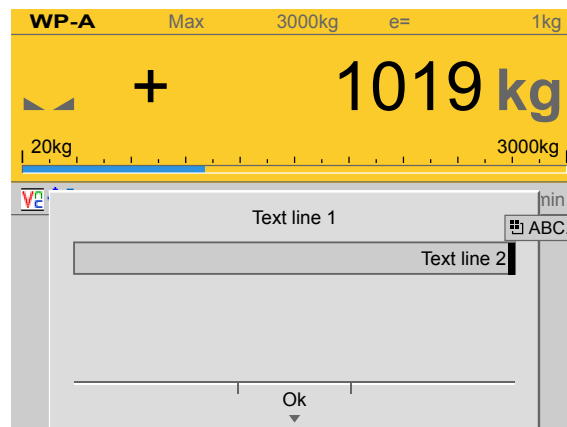

"termfun" = 2: text input

Text input: "dsp2" is displayed in line 2 and can be edited by the operator.

termstat = 1 after clicking on [OK].

termstat = 2 after pressing the **EXIT** key.

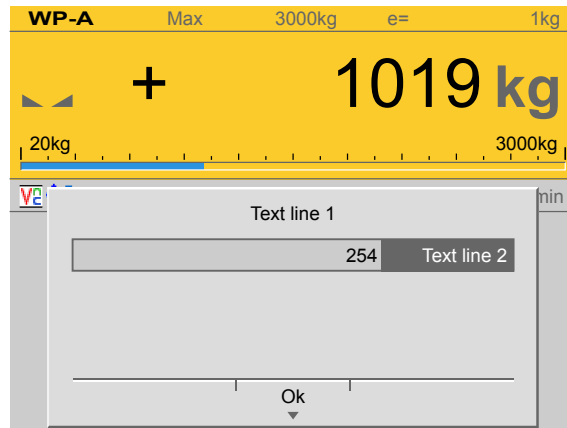

"termfun" = 3: entering a number of the "Integer" data type

The value of memory cell "editint" is displayed in line 2 and can be edited by the operator.
termstat = 1 after clicking on [OK].

termstat = 2 after pressing the **EXIT** key.

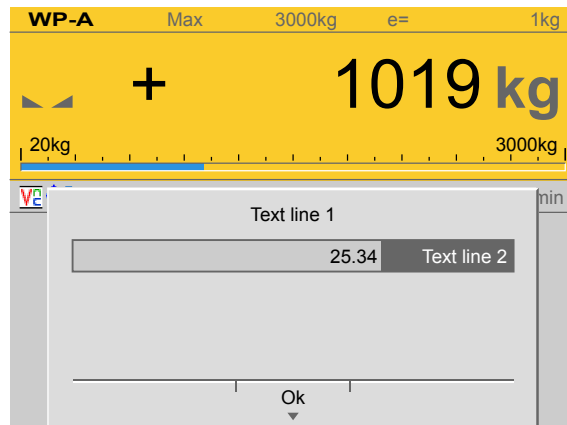

"termfun" = 4: entering a number of the "Real" data type (floating point)

The value of memory cell "editreal" is displayed in line 2 and can be edited by the operator.

termstat = 1 after clicking on [OK].

termstat = 2 after pressing the **EXIT** key.

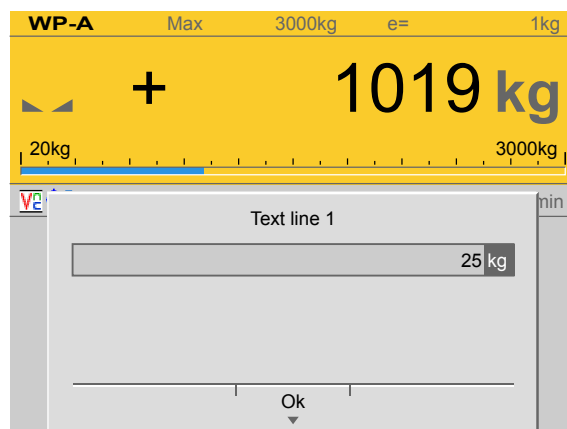

"termfun" = 5: entering a weight value

The value of memory cell "editwgt" is displayed in line 2 in the weight format of the active weighing point, and can be edited by the operator.

termstat = 1 after clicking on [OK].

termstat = 2 after pressing the **EXIT** key.

6.5.3.3 Message functions

The text content of memory cell "dsp1" is displayed in the top line. The soft key labels are predefined, but can be translated with the "PoEdit" PC program. The message function prompts the user to respond by pressing a soft key. The reply appears as a return value for the message function in "termstat" after one of the following keys has been pressed:

- [OK] = 1
- Exit = 2

termstat = 2, if the **EXIT** key has been pressed, or an exit has been executed by termfun = -1.

- Softkey2 = 3
- Softkey3 = 4
- Softkey4 = 5

Note:

It should be noted that "Softkey2", for example, does not refer to the position of the soft key, but the number of soft keys present.

With "Softkey2", therefore, two soft keys are displayed, e.g. [OK] and [No].

termstat = 3 after pressing the [No] soft key.

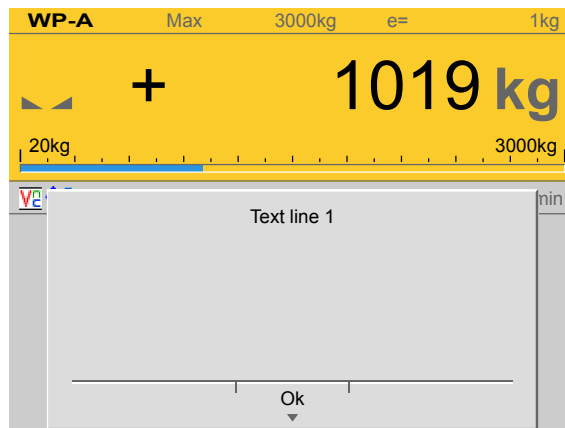

"termfun" = 10

Function displays text from line 1.

termstat = 1 after pressing the [OK] soft key.

termstat = 2 after pressing the **EXIT** key.

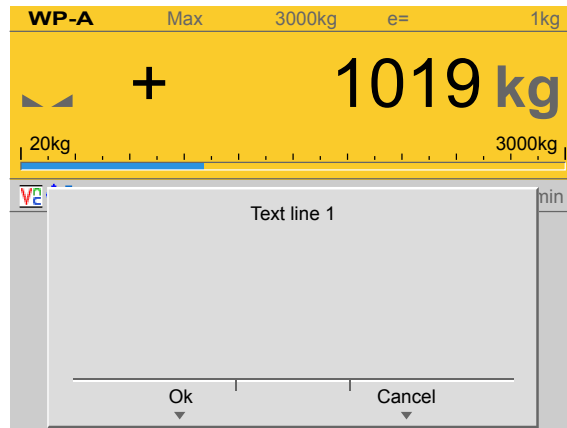

"termfun" = 11

Function displays text from line 1.

termstat = 1 after pressing the [OK] soft key.

termstat = 2 after pressing the **EXIT** key.

termstat = 3 after pressing the [Cancel] soft key.

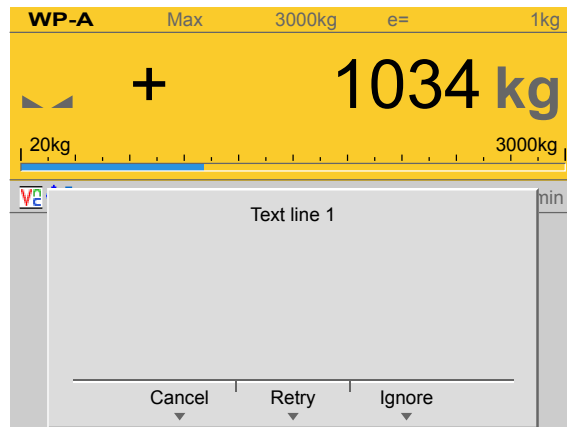

"termfun" = 12

Function displays text from line 1.

termstat = 2 after pressing the **EXIT** key.

termstat = 3 after pressing the [Cancel] soft key.

termstat = 4 after pressing the [Retry] soft key.

termstat = 5 after pressing the [Ignore] soft key.

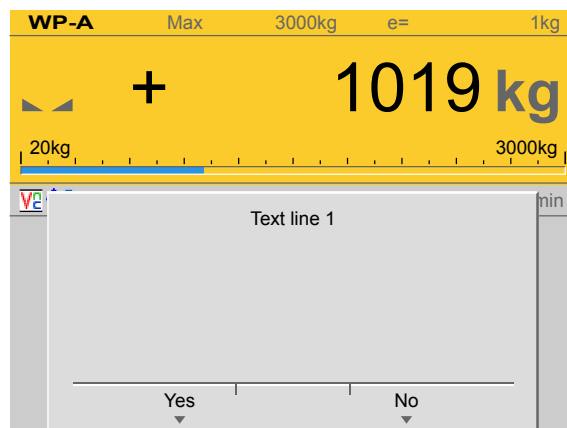

"termfun" = 13

Function displays text from line 1.

termstat = 2 after pressing the **EXIT** key.

termstat = 3 after pressing the [Yes] soft key.

termstat = 4 after pressing the [No] soft key.

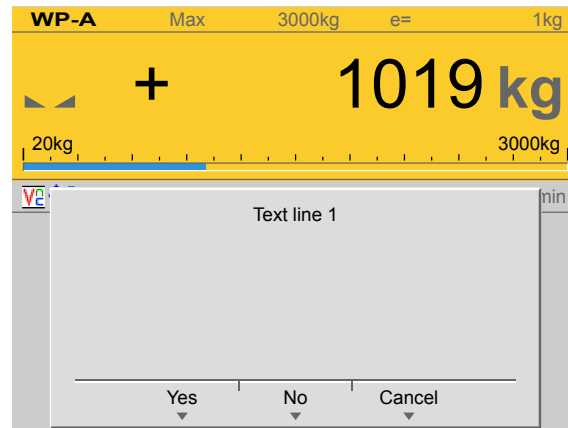
**"termfun" = 14**

Function displays text from line 1.

termstat = 2 after pressing the **EXIT** key.

termstat = 3 after pressing the [Yes] soft key.

termstat = 4 after pressing the [No] soft key.

termstat = 5 after pressing the [Cancel] soft key.

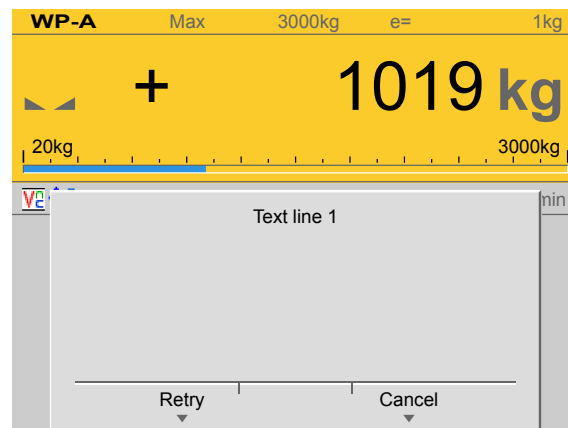
**"termfun" = 15**

Function displays text from line 1.

termstat = 2 after pressing the **EXIT** key.

termstat = 3 after pressing the [Retry] soft key.

termstat = 4 after pressing the [Cancel] soft key.

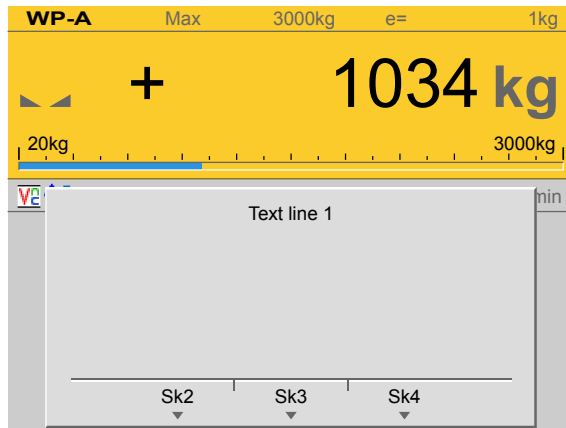

"termfun" = 16

"dsp2" supplies the information for the soft keys.

"dsp2" is 20 characters long.

Soft key 2 (Sk2)	Soft key 3 (Sk3)	Soft key 4 (Sk4)
Characters 1–6	Characters 8–13	Characters 15–20

termstat = 2 after pressing the **EXIT** key.

termstat = 3 after pressing the [Sk2] soft key.

termstat = 4 after pressing the [Sk3] soft key.

termstat = 5 after pressing the [Sk4] soft key.

Hidden inputs

(as with inputs, characters are shown by *)

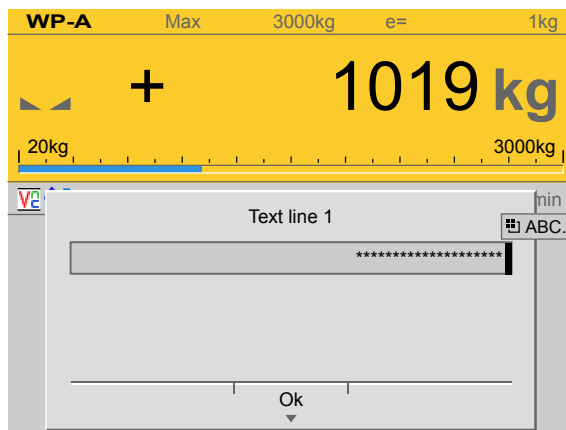

"termfun" = 20

"dsp2" is displayed in line 2 and can be edited by the operator.

"termfun" = 21

The value of memory cell "editint" is displayed in line 2 and can be edited by the operator.

termstat = 1 after pressing the [OK] soft key.

termstat = 2 after pressing the **EXIT** key.

6.5.4 Predefined functions with predefined texts

With the predefined functions in the previous Chapter (6.5.3), the texts for line 1 must be transmitted to "dsp1" and those for line 2 to "dsp2". Alternatively, the texts can also be stored in the device's "Predefined texts" database and therefore no longer need to be

transmitted. The texts in the database have an ID of 1–999, which addresses the two display texts. Only a combination of this number and the function number is transmitted. If the text ID $N * 256$ is added to the function number (in "termfun"), "dsp1" and "dsp2" are taken from the database table of predefined texts.

Example:

Function type 1 (the text in line 1 and line 2 is constantly updated) and Text ID 2 (from the predefined texts in the database)

"termfun" = function type + text ID * 256

"termfun" = 1 + 2 * 256

"termfun" = 513

7 Fieldbus interface

7.1 General notes

The interface is configured under [System settings] - [Fieldbus parameters].

Concept definition

Term/Abbreviation	Description
Master	Field bus master, usually an SPS
Slave	Field bus device
MOSI	Master Out Slave In = data is written from the SPS via the field bus to the device.
MISO	Master In Slave Out = data is returned from the device via the field bus to the SPS.

7.2 Scale protocol

7.2.1 General notes

The protocol and the functions of the firmware are described in the operating instructions PR 5900.

The additional functions of this application are described below.

7.2.2 Data exchange range

Write window (MOSI)

Byte	Field	Description
0	Write data (MSB)	Contains the data to be written, e.g., limit value.
1	Write data	
2	Write data	
3	Write data (LSB)	
4	Read_Value_Select	Selects the function for reading data.
5	Write_Value_Select	Selects the function for writing data.
6	free Res M3 Res M2 Res M1 free Set M3 Set M2 Set M1	application-specific control bits
7	GetFix Tare SetFix Tare Firm-ware Firm-ware Firm-ware Firm-ware Firm-ware Firm-ware	
	Bit 7 Bit 6 Bit 5 Bit 4 Bit 3 Bit 2 Bit 1 Bit 0	

Application-specific control bits

Field	Function
Res M1...3	Marker 1...3 is reset.
Set M1...3	Marker 1...3 is set.
GetFixTare	The gross weight is copied to the preset tare memory.
SetFixTare	Taring is performed using the value saved in the preset tare memory.

Read window (MISO)

Byte	Field	Description
0	Read data (MSB)	Contains the data to be written, e.g., limit value.
1	Read data	
2	Read data	
3	Read data (LSB)	
4	Read_Value_Selected	Read_Value_Select (function) from the write window is mirrored if the data in "Read data" is available.
5	Firm-ware Firm-ware free free free Limit 1 Limit 2 Limit 3	application-specific status bits
6	Firm-ware Firm-ware free free free Firm-ware Firm-ware Firm-ware	
7	Firm-ware Firm-ware Firm-ware Firm-ware Firm-ware Firm-ware Firm-ware Firm-ware	
	Bit 7 Bit 6 Bit 5 Bit 4 Bit 3 Bit 2 Bit 1 Bit 0	

Application-specific status bits

Field	Function
Limit 1...3	Limit 1...3 is set.

7.2.3 Function numbers

Function numbers are written to MOSI by the master (SPS) and reflected in MISO by the PR 5900.

- Function number 24...29: Limit value (read/write), see Chapter [7.2.3.1](#)
- Function number 31, 34...36: fixed values (read/write), see Chapter [7.2.3.2](#)
- Function number 45...49: terminal function: "dsp1" (read/write), see Chapter [7.2.3.3](#)
- Function number 50...54: terminal function: "dsp2" (read/write), see Chapter [7.2.3.4](#)
- Function number 130...134: dialog message 1 (read/write), see Chapter [7.2.3.5](#)
- Function number 135...139: dialog message 2 (read/write), see Chapter [7.2.3.6](#)
- Function number 141...145: dialog message 3 (read/write), see Chapter [7.2.3.7](#)

- Function number 146...150: dialog message 4 (read/write), see Chapter [7.2.3.8](#)
- Function number 151...155: dialog message 5 (read/write), see Chapter [7.2.3.9](#)
- Function number 156...160: dialog message 6 (read/write), see Chapter [7.2.3.10](#)
- Function number 161...165: dialog message 7 (read/write), see Chapter [7.2.3.11](#)
- Function number 166...170: dialog message 8 (read/write), see Chapter [7.2.3.12](#)
- Function number 171...175: dialog message 9 (read/write), see Chapter [7.2.3.13](#)
- Function number 176...180: dialog message 10 (read/write), see Chapter [7.2.3.14](#)
- Function number 190, 191: Outputs (write), see Chapter [7.2.3.15](#)
- Function number 192...195: free SPM (read/write), see Chapter [7.2.3.16](#)
- Function number 205...207: report values (read/write), see Chapter [7.2.3.17](#)
- Function number 208...210: internal Alibi values (read), see Chapter [7.2.3.18](#)
- Function number 211...213: external Alibi values (read), see Chapter [7.2.3.19](#)
- Function number 214...218: inputs (read), see Chapter [7.2.3.20](#)
- Function number 119: terminal (read), see Chapter [7.2.3.21](#)
- Function number 220...222: terminal (read/write), see Chapter [7.2.3.22](#)
- Function number 224: report (write), see Chapter [7.2.3.23](#)
- Function number 225: terminal (write), see Chapter [7.2.3.24](#)
- Function number 226: Alibi status (write), see Chapter [7.2.3.25](#)

7.2.3.1 Function number 24–29: Weight data (Read/Write)

Function number 24	Limit value 1 on
Function number 25	Limit value 1 off
Function number 26	Limit value 2 on
Function number 27	Limit value 2 off
Function number 28	Limit 3 on
Function number 29	Limit 3 off

7.2.3.2 Function number 31, 34–36: Fixed values (Read/Write)

Function number 31	Fixed value for preset tare, see also SetFixTare , GetFixTare in Chapter 7.2.2 .
Function number 34	Fixed value for set point with negative tolerance
Function number 35	Fixed value for set point
Function number 36	Fixed value for set point with positive tolerance

7.2.3.3 Function number 45–49: Terminal function: "dsp1" (Read/Write)

Function number 45	Text line 1; [Characters 1–4]
Function number 46	Text line 1; [Characters 5–8]
Function number 47	Text line 1; [Characters 9–12]
Function number 48	Text line 1; [Characters 13–16]
Function number 49	Text line 1; [Characters 17–20]

7.2.3.4 Function number 50–54: Terminal function: "dsp2" (Read/Write)

Function number 50	Text line 2; [Characters 1–4]
Function number 51	Text line 2; [Characters 5–8]
Function number 52	Text line 2; [Characters 9–12]
Function number 53	Text line 2; [Characters 13–16]
Function number 54	Text line 2; [Characters 17–20]

7.2.3.5 Function number 130–134: Dialog message 1 (Read/Write)

Register 130	Text 1; [Characters 1–4]
Register 131	Text 1; [Characters 5–8]
Register 132	Text 1; [Characters 9–12]
Register 133	Text 1; [Characters 13–16]
Register 134	Text 1; [Characters 17–20]

7.2.3.6 Function number 135–139: Dialog message 2 (Read/Write)

Function number 135	Text 2; [Characters 1–4]
Function number 136	Text 2; [Characters 5–8]
Function number 137	Text 2; [Characters 9–12]
Function number 138	Text 2; [Characters 13–16]
Function number 139	Text 2; [Characters 17–20]

7.2.3.7 Function number 141–145: Dialog message 3 (Read/Write)

Function number 141	Text 3; [Characters 1–4]
Function number 142	Text 3; [Characters 5–8]
Function number 143	Text 3; [Characters 9–12]
Function number 144	Text 3; [Characters 13–16]
Function number 145	Text 3; [Characters 17–20]

7.2.3.8 Function number 146–150: Dialog message 4 (Read/Write)

Function number 146	Text 4; [Characters 1–4]
Function number 147	Text 4; [Characters 5–8]
Function number 148	Text 4; [Characters 9–12]
Function number 149	Text 4; [Characters 13–16]
Function number 150	Text 4; [Characters 17–20]

7.2.3.9 Function number 151–155: Dialog message 5 (Read/Write)

Function number 151	Text 5; [Characters 1–4]
Function number 152	Text 5; [Characters 5–8]
Function number 153	Text 5; [Characters 9–12]
Function number 154	Text 5; [Characters 13–16]
Function number 155	Text 5; [Characters 17–20]

7.2.3.10 Function number 156–160: Dialog message 6 (Read/Write)

Function number 156	Text 6; [Characters 1–4]
Function number 157	Text 6; [Characters 5–8]
Function number 158	Text 6; [Characters 9–12]
Function number 159	Text 6; [Characters 13–16]
Function number 160	Text 6; [Characters 17–20]

7.2.3.11 Function number 161–165: Dialog message 7 (Read/Write)

Function number 161	Text 7; [Characters 1–4]
Function number 162	Text 7; [Characters 5–8]
Function number 163	Text 7; [Characters 9–12]
Function number 164	Text 7; [Characters 13–16]
Function number 165	Text 7; [Characters 17–20]

7.2.3.12 Function number 166–170: Dialog message 8 (Read/Write)

Function number 166	Text 8; [Characters 1–4]
Function number 167	Text 8; [Characters 5–8]
Function number 168	Text 8; [Characters 9–12]
Function number 169	Text 8; [Characters 13–16]
Function number 170	Text 8; [Characters 17–20]

7.2.3.13 Function number 171–175: Dialog message 9 (Read/Write)

Function number 171	Text 9; [Characters 1–4]
Function number 172	Text 9; [Characters 5–8]
Function number 173	Text 9; [Characters 9–12]
Function number 174	Text 9; [Characters 13–16]
Function number 175	Text 9; [Characters 17–20]

7.2.3.14 Function number 176–180: Dialog message 10 (Read/Write)

Function number 176	Text 10; [Characters 1–4]
Function number 177	Text 10; [Characters 5–8]
Function number 178	Text 10; [Characters 9–12]
Function number 179	Text 10; [Characters 13–16]
Function number 180	Text 10; [Characters 17–20]

7.2.3.15 Function number 190–191: Outputs (Write)

Function number 190	Analog output option-1; 0–20,000
Function number 191	Analog output option-2; 0–20,000

7.2.3.16 Function number 192–195: Free SPM (Read/Write)

Function number 192	1st DWORD, see Chapter 8
Function number 193	2nd DWORD, see Chapter 8
Function number 194	3rd DWORD, see Chapter 8
Function number 195	4th DWORD, see Chapter 8

Note:

The function numbers always refer to the current weighing point.

7.2.3.17 Function number 205–207: Report values (Read/Write)

Function number 205	Free number 1 for printout “Num_1”
Function number 206	Free number 2 for printout “Num_2”
Function number 207	Free number 3 for printout “Num_3”

7.2.3.18 Function number 208–210: Internal Alibi values (Read)

Function number 208	Alibi sequence number
Function number 209	Alibi date
Function number 210	Alibi time

7.2.3.19 Function number 211–213: External Alibi values (Read)

Function number 211	Printed gross weight value
Function number 212	Printed net weight value
Function number 213	Printed tare weight value

7.2.3.20 Function number 214–218: Inputs (Read)

Function number 214	Analog input option-1
Function number 215	Analog input option-2
Function number 216	Digital input option-1
Function number 217	Digital input option-2
Function number 218	Internal digital inputs

7.2.3.21 Function number 219: Terminal (Read)

Function number 219	Terminal status "termstat" "termstat" is included in the (MISO) Byte 3 reading window. Values for "termstart", e. g.: D100 for weighing point A, see Chapter 8.
---------------------	---

7.2.3.22 Function number 220–222: Terminal (Read/Write)

Function number 220	Terminal function "editint": numerical input of integers for printout
Function number 221	Terminal function "editreal": Entering floating point numbers
Function number 222	Terminal function "editwgt": Input of weight value

7.2.3.23 Function number 224: Report (Write)

Function number 224	Variable "repofun": Remotely activate a print order. Write the value for "repofun" in accordance with Chapter 8 (e. g. D100 for Weighing point A A) in the (MOSI) Byte 0...3 writing window.
---------------------	---

7.2.3.24 Function number 225: Terminal (Write)

Function number 225	Variable "termfun": Activate terminal function. Write the value for "termfun" in accordance with Chapter 6.5 in the (MOSI) Byte 0..3 writing window.
---------------------	--

7.2.3.25 Function number 226: Alibi status (Read)

Function number 226	MISO Byte 3 reading window contains Alibi status, see Chapter 8.11 .
---------------------	--

8 SPM

8.1 General information

The memory accessible to the user is the SPM (Scratch Pad Memory). This memory is used to store lots of internal data from which weights, statuses and reports can be read and control data can be written.

- System data are defined by the firmware and the respective application.
- The free user range can be used freely, for example, via the configuration of logical links.

The SPM table can be accessed via OPC and ModBus communication and fieldbus with SPM interface.

In addition, individual bits are copied back and forth between digital inputs and outputs and the SPM via the I/O configuration.

Note:

If a text is defined e.g. from SPM address B401, this must be defined in the OPC server from SPM address B400 so that the content actually begins at B401.

8.2 Elementary data types

The elementary data types are characterized by their bit width and possible value range. All commands of the data type BOOL are executed with a rising edge.

Data type	Description	Value range
BOOL	bool	0 (FALSE) or 1 (TRUE)
SINT	short integer	-128 to 127
INT	integer	-32768 to 32767
DINT	double integer	-2^{31} to $2^{31}-1$
LINT	long integer	-2^{63} to $2^{63}-1$
USINT	unsigned short integer	0 to 255
UINT	unsigned integer	0 to 65535
UDINT	unsigned double integer	0 to $2^{32}-1$
ULINT	unsigned long integer	0 to $2^{64}-1$
REAL	real number	$\pm 1.18E-38$ bis $3.4E38$ (with approx. 7 significant digits)
LREAL	long real number	$\pm 1.18E-308$ bis $3.4E308$ (with approx. 16 significant digits)
TIME	time duration	1 ms to $\pm 2^{47}$ ms
DATE	date (only)	1.1.1900 to 31.12.2099
TIME_OF_DAY	time of day (only)	00:00:00.00 to 23:59:59.99

Data type	Description	Value range
DATE_AND_TIME	Date and time of day	see DATE and TIME_OF_DAY
STRING	variable-long character string	max. 255 characters (ISO)
WSTRING	variable-long wide character string	max. 255 characters (Unicode)
BYTE	bit-sequence 8	...
WORD	bit-sequence 16	...
DWORD	bit-sequence 32	...
LWORD	bit-sequence 64	...

8.3 Addressing

The SPM table can be addressed via different counts. Bit addressing is used to count the individual bits (MX). Byte addressing is used to count individual bytes (MB), whereby, e.g. bits MX0..MX7 are identical to byte MB0.

Accordingly, addresses ML20, MD40-41, MW80-83, MB160-167 and MX1280-1343 contain the same data (see Chapter 8.10).

Code	Data type	Address example
%ML	LWORD	L21
%MD	DINT	D42..43
%MW	WORD	W84..87
%MB	BYTE	B168..175
%MX	BOOL (bit)	X1344...1407

8.4 System data weighing point A

SPM address	Data type	R/W	Function
X0..X3	BOOL	R	Internal digital input 1..4
X8..11	BOOL	R	Internal digital output 1..4
X16..18	BOOL	R	Output limit 1..3
B4	BYTE	R	Indicator status
X32	BOOL	R	ADC error
X33	BOOL	R	> Max (FSD = Full Scale Deflection)
X34	BOOL	R	> Max + permitted range (OVL)
X35	BOOL	R	< zero
X36	BOOL	R	Zero $\pm 1/4$ d
X37	BOOL	R	Within the zeroset range (ZSR)
X38	BOOL	R	The weight is stable
X39	BOOL	R	Weight < zero or > Max (FSD = Full Scale Deflection)

SPM address	Data type	R/W	Function
B5	BYTE	R	ADC status
X40	BOOL	R	Measuring signal negative (error 7)
X41	BOOL	R	Measuring signal >36 mV (error 3)
X42	BOOL	R	Internal arithmetic error; CAL data are perhaps faulty (error 1)
X43	BOOL	R	No or too low sense voltage (error 6)
X44	BOOL	R	No communication with xBPI scale (error 9)
B6	BYTE	R	Command status
X48	BOOL	R	Command error
X49	BOOL	R	Command active
X50	BOOL	R	Network failure signal
B7	BYTE	R	Active status
X56	BOOL	R	Test mode active
X57	BOOL	R	Calibration active
X58	BOOL	R	Instrument is tared
X59	BOOL	R	Pendeo only: no standstill
X60	BOOL	R	Pendeo only: operation with a simulated load cell
X64	BOOL	R/W	Read/write marker bit 1
X65	BOOL	R/W	Read/write marker bit 2
X66	BOOL	R/W	Read/write marker bit 3
X72	BOOL	R/W	Switch D11 to net weight.
X112	BOOL	W	Zero device.
X113	BOOL	W	Tare device
X114	BOOL	W	Reset the tare of the device
X115	BOOL	W	Start the test mode
X116	BOOL	W	Finish the test mode
X117	BOOL	W	Reset the power fail signal
X118	BOOL	W	Set fixed tare weight D31 as tare
X119	BOOL	W	Store the current gross weight in the preset tare memory (D31)
X121	BOOL	W	Reset error B19 = 0.
B16	SINT	R	Exponent Number of decimal places Example: 1.23 is displayed Exponent: 2
B17	SINT	R	Weight unit 1 = mg, 2 = g, 3 = kg, 4 = t, 5 = lb, 9 = oz
B18	SINT	R	Verification interval (for multi-interval/multi-range = d1 or e1)
B19	BYTE	R	Last weighing point error, see PR 5900 operating instructions.
B20	BYTE	R	Higher byte of product code (0x59)
B21	BYTE	R	Lower byte of product code (0x00)

SPM address	Data type	R/W	Function
B22	BYTE	R	Major part of version number (1.0)
B23	BYTE	R	Minor part of version number (1.0)
B31	BYTE	R	ADC status
D6	UDINT	R	Serial number (board number)
W14	INT	R	Counter will be increased for every measured value.
D8	DINT	R	Current gross weight
D9	DINT	R	Current net weight
D10	DINT	R	Current tare weight
D11	DINT	R	Current gross/net weight selected with X72
D12	DINT	R	Gross value with magnifier 100 (centi d)
D13	DINT	R	Tare value with magnifier 100 (centi d)
D14	DINT	R	Max weight (FSD = Full Scale Deflection)
D15	DINT	R	Min weight
D16	DINT	R	Report: Gross weight
D17	DINT	R	Report: Net weight
D18	DINT	R	Report: Tare weight
D19	DINT	R	Report: Sequence number
B80	BYTE	R	Alibi status, see Chapter 8.11 .
D21	DINT	R	Report: Date
D22	DINT	R	Report: Time
D24	DINT	R/W	Limit 1 on
D25	DINT	R/W	Limit 1 off
D26	DINT	R/W	Limit 2 on
D27	DINT	R/W	Limit 2 off
D28	DINT	R/W	Limit 3 on
D29	DINT	R/W	Limit 3 off
D31	DINT	R/W	Preset tare memory (X118, X119)

SPM address	Data type	R/W	Function
B128	BYTE		Indicator status 1
X1024	BOOL	R	The application is ready.
X1025	BOOL	R	Weighing or check weighing application is active.
X1026	BOOL	R/W	Dialog window is active.
X1027	BOOL	R/W	Start printing. This corresponds to pressing the Print key.
X1028	BOOL	R/W	It is not possible to exit weighing, check weighing or terminal function because the lock is active.
B129	BYTE		Indicator status 2
X1033	BOOL	R	Weighing point is "W&M."
X1034	BOOL	R	The weighing point is a user-defined scale or a liquid counter.
X1036	BOOL	R	This WP is selected and is visible on the display.
B130	BYTE		Indicator status: Bar graph of statuses
X1040	BOOL	R	0...-Tolerance
X1041	BOOL	R	-Tolerance...+Tolerance
X1042	BOOL	R	+Tolerance...Max
X1043	BOOL	R	Outside tolerance
D33...37	DINT		Terminal function "dsp1" (line 1)
B132...135	BYTE [20]	R/W	Part 1
B136...139	BYTE [20]	R/W	Part 2
B140...143	BYTE [20]	R/W	Part 3
B144...147	BYTE [20]	R/W	Part 4
B148...151	BYTE [20]	R/W	Part 5
D38...42	DINT		Terminal function "dsp2" (line 2)
B152...155	BYTE [20]	R/W	Part 1
B156...159	BYTE [20]	R/W	Part 2
B160...163	BYTE [20]	R/W	Part 3
B164...167	BYTE [20]	R/W	Part 4
B168...171	BYTE [20]	R/W	Part 5
D43...47	DINT		Dialog text 1
B172...175	BYTE [20]	R/W	Part 1
B176...179	BYTE [20]	R/W	Part 2
B180...183	BYTE [20]	R/W	Part 3
B184...187	BYTE [20]	R/W	Part 4
B188...191	BYTE [20]	R/W	Part 5
D48...52	DINT		Dialog text 2
B192...195	BYTE [20]	R/W	Part 1
B196...199	BYTE [20]	R/W	Part 2
B200...203	BYTE [20]	R/W	Part 3
B204...207	BYTE [20]	R/W	Part 4
B208...211	BYTE [20]	R/W	Part 5

SPM address	Data type	R/W	Function
D53...57	DINT		Dialog text 3
B212...215	BYTE [20]	R/W	Part 1
B216...219	BYTE [20]	R/W	Part 2
B220...223	BYTE [20]	R/W	Part 3
B224...227	BYTE [20]	R/W	Part 4
B228...231	BYTE [20]	R/W	Part 5
D58...62	DINT		Dialog text 4
B232...235	BYTE [20]	R/W	Part 1
B236...239	BYTE [20]	R/W	Part 2
B240...243	BYTE [20]	R/W	Part 3
B244...247	BYTE [20]	R/W	Part 4
B248...251	BYTE [20]	R/W	Part 5
D63...67	DINT		Dialog text 5
B252...255	BYTE [20]	R/W	Part 1
B256...259	BYTE [20]	R/W	Part 2
B260...263	BYTE [20]	R/W	Part 3
B264...267	BYTE [20]	R/W	Part 4
B268...271	BYTE [20]	R/W	Part 5
D68...72	DINT		Dialog text 6
B272...275	BYTE [20]	R/W	Part 1
B276...279	BYTE [20]	R/W	Part 2
B280...283	BYTE [20]	R/W	Part 3
B284...287	BYTE [20]	R/W	Part 4
B288...291	BYTE [20]	R/W	Part 5
D73...77	DINT		Dialog text 7
B292...295	BYTE [20]	R/W	Part 1
B296...299	BYTE [20]	R/W	Part 2
B300...303	BYTE [20]	R/W	Part 3
B304...307	BYTE [20]	R/W	Part 4
B308...311	BYTE [20]	R/W	Part 5
D78...82	DINT		Dialog text 8
B312...315	BYTE [20]	R/W	Part 1
B316...319	BYTE [20]	R/W	Part 2
B320...323	BYTE [20]	R/W	Part 3
B324...327	BYTE [20]	R/W	Part 4
B328...331	BYTE [20]	R/W	Part 5
D83...87	DINT		Dialog text 9
B332...335	BYTE [20]	R/W	Part 1
B336...339	BYTE [20]	R/W	Part 2
B340...343	BYTE [20]	R/W	Part 3
B344...347	BYTE [20]	R/W	Part 4
B348...351	BYTE [20]	R/W	Part 5

SPM address	Data type	R/W	Function
D88...92	DINT		Dialog text 10
B352...355	BYTE [20]	R/W	Part 1
B356...359	BYTE [20]	R/W	Part 2
B360...363	BYTE [20]	R/W	Part 3
B364...367	BYTE [20]	R/W	Part 4
B368...371	BYTE [20]	R/W	Part 5
D94	DINT	R/W	Terminal function: Variable "termfun" Values for "termfun" in accordance with Chapter 6.5 .
D95	DINT	R/W	Terminal status: Variable "termstat" Values for "termstat" in accordance with Chapter 6.5 .
D96	DINT	R/W	Free number 1 for printout "Num_1," see Chapter 10.3 .
D97	DINT	R/W	Free number 2 for printout "Num_2," see Chapter 10.3 .
D98	DINT	R/W	Free number 3 for printout "Num_3," see Chapter 10.3 .
D99	DINT	R/W	Terminal function "editint": Input of integers
D100	DINT	R/W	Variable "repofun": Value > 0 triggers the print order remotely for the current application (weighing or check weighing) with the number of printouts according to the configuration.
D101	DINT	R	Variable "repostat": Request print status remotely (-1 = Error, 0 = OK) or value > 0 triggers the print order remotely for the current application (weighing or check weighing) with the number of printouts = value.
D103	DINT	R/W	Terminal function "editreal": Input of floating point numbers
D104	DINT	R/W	Terminal function "editwgt": Input of weight value
X3472	BOOL	R	Tare status for printout: Scale tared/not tared
B440	BYTE [12]	R/W	Terminal function "edit_wgt_w": Weight value
D114	DINT	R/W	Check weighing: Set point min.
D115	DINT	R/W	Check weighing: Set point
D116	DINT	R/W	Check weighing: Set point max.
X3748	BOOL	R	Binary weight output, Bit 12 (MSB)
X3749	BOOL	R	Binary weight output, Bit 11
X3750	BOOL	R	Binary weight output, Bit 10
X3751	BOOL	R	Binary weight output, Bit 9
X3752	BOOL	R	Binary weight output, Bit 8
X3753	BOOL	R	Binary weight output, Bit 7
X3754	BOOL	R	Binary weight output, Bit 6

SPM address	Data type	R/W	Function
X3755	BOOL	R	Binary weight output, Bit 5
X3756	BOOL	R	Binary weight output, Bit 4
X3757	BOOL	R	Binary weight output, Bit 3
X3758	BOOL	R	Binary weight output, Bit 2
X3759	BOOL	R	Binary weight output, Bit 1 (LSB)

Note:

Freely assignable SPM addresses D124...D127, see Chapter [8.10](#).

Note:

The system variables (e.g. ST_WGT_A) for communication via OPC are described in operating instructions PR 1792 (Chapter 4 + 5).

8.5 System data weighing point B

SPM address	Data type	R/W	Function
X4096...4099	BOOL	R	Internal digital input 1..4
X4104...4107	BOOL	R	Internal digital output 1..4
X4112...4114	BOOL	R	Output limit 1..3
B516	BYTE	R	Indicator status
X4128	BOOL	R	ADC error
X4129	BOOL	R	> Max (FSD = Full Scale Deflection)
X4130	BOOL	R	> Max + permitted range (OVL)
X4131	BOOL	R	< zero
X4132	BOOL	R	Zero $\pm 1/4$ d
X4133	BOOL	R	Within the zeroset range (ZSR)
X4134	BOOL	R	The weight is stable
X4135	BOOL	R	Weight < zero or > Max (FSD = Full Scale Deflection)
B517	BYTE	R	ADC status
X4136	BOOL	R	Measuring signal negative (error 7)
X4137	BOOL	R	Measuring signal >36 mV (error 3)
X4138	BOOL	R	Internal arithmetic error; CAL data are perhaps faulty (error 1)
X4139	BOOL	R	No or too low sense voltage (error 6)
X4140	BOOL	R	No communication with xBPI scale (error 9)
B518	BYTE	R	Command status
X4144	BOOL	R	Command error
X4145	BOOL	R	Command active
X4146	BOOL	R	Network failure signal

SPM address	Data type	R/W	Function
B519	BYTE	R	Active status
X4152	BOOL	R	Test mode active
X4153	BOOL	R	Calibration active
X4154	BOOL	R	Instrument is tared
X4155	BOOL	R	Pendeo only: no standstill
X4156	BOOL	R	Pendeo only: operation with a simulated load cell
X4160	BOOL	R/W	Read/write marker bit 1
X4161	BOOL	R/W	Read/write marker bit 2
X4162	BOOL	R/W	Read/write marker bit 3
X4168	BOOL	R/W	Switch D139 to net weight.
X4208	BOOL	W	Zero device.
X4209	BOOL	W	Tare device
X4210	BOOL	W	Reset the tare of the device
X4211	BOOL	W	Start the test mode
X4212	BOOL	W	Finish the test mode
X4213	BOOL	W	Reset the power fail signal
X4214	BOOL	W	Set fixed tare weight D159 as tare
X4215	BOOL	W	Store the current gross weight in the preset tare memory (D159)
X4217	BOOL	W	Reset error B531 = 0.
B528	SINT	R	Exponent Number of decimal places Example: 1.23 is displayed Exponent: 2
B529	SINT	R	Weight unit 1 = mg, 2 = g, 3 = kg, 4 = t, 5 = lb, 9 = oz
B530	SINT	R	Verification interval (for multi-interval/multi-range = d1 or e1)
B531	BYTE	R	Last weighing point error, see PR 5900 operating instructions.
B532	BYTE	R	Higher byte of product code (0x59)
B533	BYTE	R	Lower byte of product code (0x00)
B534	BYTE	R	Major part of version number (1.0)
B535	BYTE	R	Minor part of version number (1.0)
B543	BYTE	R	ADC status
D134	UDINT	R	Serial number (board number)
W270	INT	R	Counter will be increased for every measured value.
D136	DINT	R	Current gross weight

SPM address	Data type	R/W	Function
D137	DINT	R	Current net weight
D138	DINT	R	Current tare weight
D139	DINT	R	Current gross/net weight selected with X4168
D140	DINT	R	Gross value with magnifier 100 (centi d)
D141	DINT	R	Tare value with magnifier 100 (centi d)
D142	DINT	R	Max weight (FSD = Full Scale Deflection)
D143	DINT	R	Min weight
D144	DINT	R	Report: Gross weight
D145	DINT	R	Report: Net weight
D146	DINT	R	Report: Tare weight
D147	DINT	R	Report: Sequence number
B592	BYTE	R	Alibi status, see Chapter 8.11.
D149	DINT	R	Report: Date
D150	DINT	R	Report: Time
D152	DINT	R/W	Limit 1 on
D153	DINT	R/W	Limit 1 off
D154	DINT	R/W	Limit 2 on
D155	DINT	R/W	Limit 2 off
D156	DINT	R/W	Limit 3 on
D157	DINT	R/W	Limit 3 off
D159	DINT	R/W	Preset tare memory (X4214, X4215)
B640	BYTE		Indicator status 1
X5120	BOOL	R	The application is ready.
X5121	BOOL	R	Weighing or check weighing application is active.
X5122	BOOL	R/W	Dialog window is active.
X5123	BOOL	R/W	Start printing. This corresponds to pressing the Print key.
X5124	BOOL	R/W	It is not possible to exit weighing, check weighing or terminal function because the lock is active.
B641	BYTE		Indicator status 2
X5129	BOOL	R	Weighing point is "W&M."
X5130	BOOL	R	The weighing point is a user-defined scale or a liquid counter.
X5132	BOOL	R	This WP is selected and is visible on the display.

SPM address	Data type	R/W	Function
B642	BYTE		Indicator status: Bar graph of statuses
X5136	BOOL	R	0...-Tolerance
X5137	BOOL	R	-Tolerance...+Tolerance
X5138	BOOL	R	+Tolerance...Max
X5139	BOOL	R	Outside tolerance
D161...165	DINT		Terminal function "dsp1" (line 1)
B644...647	BYTE [20]	R/W	Part 1
B648...651	BYTE [20]	R/W	Part 2
B652...655	BYTE [20]	R/W	Part 3
B656...659	BYTE [20]	R/W	Part 4
B660...663	BYTE [20]	R/W	Part 5
D166...170	DINT		Terminal function "dsp2" (line 2)
B664...667	BYTE [20]	R/W	Part 1
B668...671	BYTE [20]	R/W	Part 2
B672...675	BYTE [20]	R/W	Part 3
B676...679	BYTE [20]	R/W	Part 4
B680...683	BYTE [20]	R/W	Part 5
D171...175	DINT		Dialog text 1
B684...687	BYTE [20]	R/W	Part 1
B688...691	BYTE [20]	R/W	Part 2
B692...695	BYTE [20]	R/W	Part 3
B696...699	BYTE [20]	R/W	Part 4
B700...703	BYTE [20]	R/W	Part 5
D176...180	DINT		Dialog text 2
B704...707	BYTE [20]	R/W	Part 1
B708...711	BYTE [20]	R/W	Part 2
B712...715	BYTE [20]	R/W	Part 3
B716...719	BYTE [20]	R/W	Part 4
B720...723	BYTE [20]	R/W	Part 5
D181...185	DINT		Dialog text 3
B724...727	BYTE [20]	R/W	Part 1
B728...731	BYTE [20]	R/W	Part 2
B732...735	BYTE [20]	R/W	Part 3
B736...739	BYTE [20]	R/W	Part 4
B740...743	BYTE [20]	R/W	Part 5
D186...190	DINT		Dialog text 4
B744...747	BYTE [20]	R/W	Part 1
B748...751	BYTE [20]	R/W	Part 2
B752...755	BYTE [20]	R/W	Part 3
B756...759	BYTE [20]	R/W	Part 4
B760...763	BYTE [20]	R/W	Part 5

SPM address	Data type	R/W	Function
D191...195	DINT		Dialog text 5
B764...767	BYTE [20]	R/W	Part 1
B768...771	BYTE [20]	R/W	Part 2
B772...775	BYTE [20]	R/W	Part 3
B776...779	BYTE [20]	R/W	Part 4
B780...783	BYTE [20]	R/W	Part 5
D196...200	DINT		Dialog text 6
B784...787	BYTE [20]	R/W	Part 1
B788...791	BYTE [20]	R/W	Part 2
B792...795	BYTE [20]	R/W	Part 3
B796...799	BYTE [20]	R/W	Part 4
B800...803	BYTE [20]	R/W	Part 5
D201...205	DINT		Dialog text 7
B804...807	BYTE [20]	R/W	Part 1
B808...811	BYTE [20]	R/W	Part 2
B812...815	BYTE [20]	R/W	Part 3
B816...819	BYTE [20]	R/W	Part 4
B820...823	BYTE [20]	R/W	Part 5
D206...210	DINT		Dialog text 8
B824...827	BYTE [20]	R/W	Part 1
B828...831	BYTE [20]	R/W	Part 2
B832...835	BYTE [20]	R/W	Part 3
B836...839	BYTE [20]	R/W	Part 4
B840...843	BYTE [20]	R/W	Part 5
D211...215	DINT		Dialog text 9
B844...847	BYTE [20]	R/W	Part 1
B848...851	BYTE [20]	R/W	Part 2
B852...855	BYTE [20]	R/W	Part 3
B856...859	BYTE [20]	R/W	Part 4
B860...863	BYTE [20]	R/W	Part 5
D216...220	DINT		Dialog text 10
B864...867	BYTE [20]	R/W	Part 1
B868...871	BYTE [20]	R/W	Part 2
B872...875	BYTE [20]	R/W	Part 3
B876...879	BYTE [20]	R/W	Part 4
B880...883	BYTE [20]	R/W	Part 5
D222	DINT	R/W	Terminal function: Variable "termfun" Values for "termfun" in accordance with Chapter 6.5 .
D223	DINT	R/W	Terminal status: Variable "termstat" Values for "termstat" in accordance with Chapter 6.5 .
D224	DINT	R/W	Free number 1 for printout "Num_1," see Chapter 10.3 .
D225	DINT	R/W	Free number 2 for printout "Num_2," see Chapter 10.3 .
D226	DINT	R/W	Free number 3 for printout "Num_3," see Chapter 10.3 .

SPM address	Data type	R/W	Function
D227	DINT	R/W	Terminal function "editint": Input of integers
D228	DINT	R/W	Variable "repofun": Value > 0 triggers the print order remotely for the current application (weighing or check weighing) with the number of printouts according to the configuration.
D229	DINT	R	Variable "repostat": Request print status remotely (-1 = Error, 0 = OK) or value > 0 triggers the print order remotely for the current application (weighing or check weighing) with the number of printouts = value.
D231	DINT	R/W	Terminal function "editreal": Input of floating point numbers
D232	DINT	R/W	Terminal function "editwgt": Input of weight value
X7568	BOOL	R	Tare status for printout: Scale tared/not tared
B952	BYTE [12]	R/W	Terminal function "edit_wgt_w": Weight value
D242	DINT	R/W	Check weighing: Set point min.
D243	DINT	R/W	Check weighing: Set point
D244	DINT	R/W	Check weighing: Set point max.
X7844	BOOL	R	Binary weight output, Bit 12 (MSB)
X7845	BOOL	R	Binary weight output, Bit 11
X7846	BOOL	R	Binary weight output, Bit 10
X7847	BOOL	R	Binary weight output, Bit 9
X7848	BOOL	R	Binary weight output, Bit 8
X7849	BOOL	R	Binary weight output, Bit 7
X7850	BOOL	R	Binary weight output, Bit 6
X7851	BOOL	R	Binary weight output, Bit 5
X7852	BOOL	R	Binary weight output, Bit 4
X7853	BOOL	R	Binary weight output, Bit 3
X7854	BOOL	R	Binary weight output, Bit 2
X7855	BOOL	R	Binary weight output, Bit 1 (LSB)

Note:

Freely assignable SPM addresses D252...D255, see Chapter [8.10](#).

Note:

The system variables (e.g. ST_WGT_A) for communication via OPC are described in operating instructions PR 1792 (Chapter 4 + 5).

8.6 System data weighing point C

SPM address	Data type	R/W	Function
X8192...8195	BOOL	R	Internal digital input 1...4
X8200...8203	BOOL	R	Internal digital output 1...4
X8208...8210	BOOL	R	Output limit 1...3
B1028	BYTE	R	Indicator status
X8224	BOOL	R	ADC error
X8225	BOOL	R	> Max (FSD = Full Scale Deflection)
X8226	BOOL	R	> Max + permitted range (OVL)
X8227	BOOL	R	< zero
X8228	BOOL	R	Zero $\pm 1/4$ d
X8229	BOOL	R	Within the zeroset range (ZSR)
X8230	BOOL	R	The weight is stable
X8231	BOOL	R	Weight < zero or > Max (FSD = Full Scale Deflection)
B1029	BYTE	R	ADC status
X8232	BOOL	R	Measuring signal negative (error 7)
X8233	BOOL	R	Measuring signal >36 mV (error 3)
X8234	BOOL	R	Internal arithmetic error; CAL data are perhaps faulty (error 1)
X8235	BOOL	R	No or too low sense voltage (error 6)
X8236	BOOL	R	No communication with xBPI scale (error 9)
B1030	BYTE	R	Command status
X8240	BOOL	R	Command error
X8241	BOOL	R	Command active
X8242	BOOL	R	Network failure signal
B1031	BYTE	R	Active status
X8248	BOOL	R	Test mode active
X8249	BOOL	R	Calibration active
X8250	BOOL	R	Instrument is tared
X8251	BOOL	R	Pendeo only: no standstill
X8252	BOOL	R	Pendeo only: operation with a simulated load cell
X8256	BOOL	R/W	Read/write marker bit 1
X8257	BOOL	R/W	Read/write marker bit 2
X8258	BOOL	R/W	Read/write marker bit 3
X8264	BOOL	R/W	Switch D267 to net weight.
X8304	BOOL	W	Zero device.
X8305	BOOL	W	Tare device
X8306	BOOL	W	Reset the tare of the device
X8307	BOOL	W	Start the test mode
X8308	BOOL	W	Finish the test mode
X8309	BOOL	W	Reset the power fail signal
X8310	BOOL	W	Set fixed tare weight D287 as tare

SPM address	Data type	R/W	Function
X8311	BOOL	W	Store the current gross weight in the preset tare memory (D287)
X8313	BOOL	W	Reset error B1043 = 0.
B1040	SINT	R	Exponent Number of decimal places Example: 1.23 is displayed Exponent: 2
B1041	SINT	R	Weight unit 1 = mg, 2 = g, 3 = kg, 4 = t, 5 = lb, 9 = oz
B1042	SINT	R	Verification interval (for multi-interval/multi-range = d1 or e1)
B1043	BYTE	R	Last weighing point error, see PR 5900 operating instructions.
B1044	BYTE	R	Higher byte of product code (0x59)
B1045	BYTE	R	Lower byte of product code (0x00)
B1046	BYTE	R	Major part of version number (1.0)
B1047	BYTE	BYTE	Minor part of version number (1.0)
B1055	BYTE	BYTE	ADC status
D262	UDINT	R	Serial number (board number)
W526	INT	R	Counter will be increased for every measured value.
D264	DINT	R	Current gross weight
D265	DINT	R	Current net weight
D266	DINT	R	Current tare weight
D267	DINT	R	Current gross/net weight selected with X8264
D268	DINT	R	Gross value with magnifier 100 (centi d)
D269	DINT	R	Tare value with magnifier 100 (centi d)
D270	DINT	R	Max weight (FSD = Full Scale Deflection)
D271	DINT	R	Min weight
D272	DINT	R	Report: Gross weight
D273	DINT	R	Report: Net weight
D274	DINT	R	Report: Tare weight
D275	DINT	R	Report: Sequence number
B1104	BYTE	R	Alibi status, see Chapter 8.11 .
D277	DINT	R	Report: Date
D278	DINT	R	Report: Time
D280	DINT	R/W	Limit 1 on

SPM address	Data type	R/W	Function
D281	DINT	R/W	Limit 1 off
D282	DINT	R/W	Limit 2 on
D283	DINT	R/W	Limit 2 off
D284	DINT	R/W	Limit 3 on
D285	DINT	R/W	Limit 3 off
D287	DINT	R/W	Preset tare memory (X8311, X8312)
B1152	BYTE		Indicator status 1
X9216	BOOL	R	The application is ready.
X9217	BOOL	R	Weighing or check weighing application is active.
X9218	BOOL	R/W	Dialog window is active.
X9219	BOOL	R/W	Start printing. This corresponds to pressing the Print key.
X9220	BOOL	R/W	It is not possible to exit weighing, check weighing or terminal function because the lock is active.
B1153	BYTE		Indicator status 2
X9225	BOOL	R	Weighing point is "W&M."
X9226	BOOL	R	The weighing point is a user-defined scale or a liquid counter. This WP is selected and is visible on the display.
X9228	BOOL	R	
B1154	BYTE		Indicator status: Bar graph of statuses
X9232	BOOL	R	0...-Tolerance
X9233	BOOL	R	-Tolerance...+Tolerance
X9234	BOOL	R	+Tolerance...Max
X9235	BOOL	R	Outside tolerance
D289...293	DINT		Terminal function "dsp1" (line 1)
B1156...1159	BYTE [20]	R/W	Part 1
B1160...1163	BYTE [20]	R/W	Part 2
B1164...1167	BYTE [20]	R/W	Part 3
B1168...1171	BYTE [20]	R/W	Part 4
B1172...1175	BYTE [20]	R/W	Part 5
D294...298	DINT		Terminal function "dsp2" (line 2)
B1176...1179	BYTE [20]	R/W	Part 1
B1180...1183	BYTE [20]	R/W	Part 2
B1184...1187	BYTE [20]	R/W	Part 3
B1188...1191	BYTE [20]	R/W	Part 4
B1192...1195	BYTE [20]	R/W	Part 5
D299...303	DINT		Dialog text 1
B1196...1199	BYTE [20]	R/W	Part 1
B1200...1203	BYTE [20]	R/W	Part 2
B1204...1207	BYTE [20]	R/W	Part 3
B1208...1211	BYTE [20]	R/W	Part 4
B1212...1215	BYTE [20]	R/W	Part 5

SPM address	Data type	R/W	Function
D304...308	DINT		Dialog text 2
B1216...1219	BYTE [20]	R/W	Part 1
B1220...1223	BYTE [20]	R/W	Part 2
B1224...1227	BYTE [20]	R/W	Part 3
B1228...1231	BYTE [20]	R/W	Part 4
B1232...1235	BYTE [20]	R/W	Part 5
D309...313	DINT		Dialog text 3
B1236...1239	BYTE [20]	R/W	Part 1
B1240...1243	BYTE [20]	R/W	Part 2
B1244...1247	BYTE [20]	R/W	Part 3
B1248...1251	BYTE [20]	R/W	Part 4
B1252...1255	BYTE [20]	R/W	Part 5
D314...318	DINT		Dialog text 4
B1256...1259	BYTE [20]	R/W	Part 1
B1260...1263	BYTE [20]	R/W	Part 2
B1264...1267	BYTE [20]	R/W	Part 3
B1268...1271	BYTE [20]	R/W	Part 4
B1272...1275	BYTE [20]	R/W	Part 5
D319...323	DINT		Dialog text 5
B1276...1279	BYTE [20]	R/W	Part 1
B1280...1283	BYTE [20]	R/W	Part 2
B1284...1287	BYTE [20]	R/W	Part 3
B1288...1291	BYTE [20]	R/W	Part 4
B1292...1295	BYTE [20]	R/W	Part 5
D324...328	DINT		Dialog text 6
B1296...1299	BYTE [20]	R/W	Part 1
B1300...1303	BYTE [20]	R/W	Part 2
B1304...1307	BYTE [20]	R/W	Part 3
B1308...1311	BYTE [20]	R/W	Part 4
B1312...1315	BYTE [20]	R/W	Part 5
D329...333	DINT		Dialog text 7
B1316...1319	BYTE [20]	R/W	Part 1
B1320...1323	BYTE [20]	R/W	Part 2
B1324...1327	BYTE [20]	R/W	Part 3
B1328...1331	BYTE [20]	R/W	Part 4
B1332...1335	BYTE [20]	R/W	Part 5
D334...338	DINT		Dialog text 8
B1336...1339	BYTE [20]	R/W	Part 1
B1340...1343	BYTE [20]	R/W	Part 2
B1344...1347	BYTE [20]	R/W	Part 3
B1348...1351	BYTE [20]	R/W	Part 4
B1352...1355	BYTE [20]	R/W	Part 5

SPM address	Data type	R/W	Function
D339...343	DINT		Dialog text 9
B1356...1359	BYTE [20]	R/W	Part 1
B1360...1363	BYTE [20]	R/W	Part 2
B1364...1367	BYTE [20]	R/W	Part 3
B1368...1371	BYTE [20]	R/W	Part 4
B1372...1375	BYTE [20]	R/W	Part 5
D344...348	DINT		Dialog text 10
B1376...1379	BYTE [20]	R/W	Part 1
B1380...1383	BYTE [20]	R/W	Part 2
B1384...1387	BYTE [20]	R/W	Part 3
B1388...1391	BYTE [20]	R/W	Part 4
B1392...1395	BYTE [20]	R/W	Part 5
D350	DINT	R/W	Terminal function: Variable "termfun" Values for "termfun" in accordance with Chapter 6.5.
D351	DINT	R/W	Terminal status: Variable "termstat" Values for "termstat" in accordance with Chapter 6.5.
D352	DINT	R/W	Free number 1 for printout "Num_1," see Chapter 10.3.
D353	DINT	R/W	Free number 2 for printout "Num_2," see Chapter 10.3.
D354	DINT	R/W	Free number 3 for printout "Num_3," see Chapter 10.3.
D355	DINT	R/W	Terminal function "editint": Input of integers
D356	DINT	R/W	Variable "repopun": Value > 0 triggers the print order remotely for the current application (weighing or check weighing) with the number of printouts according to the configuration.
D357	DINT	R	Variable "repostat": Request print status remotely (-1 = Error, 0 = OK) or value > 0 triggers the print order remotely for the current application (weighing or check weighing) with the number of printouts = value.
D359	DINT	R/W	Terminal function "editreal": Input of floating point numbers
D360	DINT	R/W	Terminal function "editwgt": Input of weight value
X11664	BOOL	R	Tare status for printout: Scale tared/not tared
B1464	BYTE [12]	R/W	Terminal function "edit_wgt_w": Weight value
D370	DINT	R/W	Check weighing: Set point min.
D371	DINT	R/W	Check weighing: Set point
D372	DINT	R/W	Check weighing: Set point max.
X11940	BOOL	R	Binary weight output, Bit 12 (MSB)
X11941	BOOL	R	Binary weight output, Bit 11

SPM address	Data type	R/W	Function
X11942	BOOL	R	Binary weight output, Bit 10
X11943	BOOL	R	Binary weight output, Bit 9
X11944	BOOL	R	Binary weight output, Bit 8
X11945	BOOL	R	Binary weight output, Bit 7
X11946	BOOL	R	Binary weight output, Bit 6
X11947	BOOL	R	Binary weight output, Bit 5
X11948	BOOL	R	Binary weight output, Bit 4
X11949	BOOL	R	Binary weight output, Bit 3
X11950	BOOL	R	Binary weight output, Bit 2
X11951	BOOL	R	Binary weight output, Bit 1 (LSB)

Note:

Freely assignable SPM addresses D380...D383, see Chapter 8.10.

Note:

The system variables (e.g. ST_WGT_A) for communication via OPC are described in operating instructions PR 1792 (Chapter 4 + 5).

8.7 System data weighing point D

SPM address	Data type	R/W	Function
X12288...12291	BOOL	R	Internal digital input 1..4
X12296...12299	BOOL	R	Internal digital output 1..4
X12304...12306	BOOL	R	Output limit 1..3
B1540	BYTE	R	Indicator status
X12320	BOOL	R	ADC error
X12321	BOOL	R	> Max (FSD = Full Scale Deflection)
X12322	BOOL	R	> Max + permitted range (OVL)
X12323	BOOL	R	< zero
X12324	BOOL	R	Zero $\pm 1/4$ d
X12325	BOOL	R	Within the zeroset range (ZSR)
X12326	BOOL	R	The weight is stable
X12327	BOOL	R	Weight < zero or > Max (FSD = Full Scale Deflection)
B1541	BYTE	R	ADC status
X12328	BOOL	R	Measuring signal negative (error 7)
X12329	BOOL	R	Measuring signal >36 mV (error 3)
X12330	BOOL	R	Internal arithmetic error; CAL data are perhaps faulty (error 1)
X12331	BOOL	R	No or too low sense voltage (error 6)
X12332	BOOL	R	No communication with xBPI scale (error 9)

SPM address	Data type	R/W	Function
B1542	BYTE	R	Command status
X12336	BOOL	R	Command error
X12337	BOOL	R	Command active
X12338	BOOL	R	Network failure signal
B1543	BYTE	R	Active status
X12344	BOOL	R	Test mode active
X12345	BOOL	R	Calibration active
X12346	BOOL	R	Instrument is tared
X12347	BOOL	R	Pendeo only: no standstill
X12348	BOOL	R	Pendeo only: Operation with a simulated load cell
X12352	BOOL	R/W	Read/write marker bit 1
X12353	BOOL	R/W	Read/write marker bit 2
X12354	BOOL	R/W	Read/write marker bit 3
X12360	BOOL	R/W	Switch D395 to net weight.
X12400	BOOL	W	Zero device.
X12401	BOOL	W	Tare device
X12402	BOOL	W	Reset the tare of the device
X12403	BOOL	W	Start the test mode
X12404	BOOL	W	Finish the test mode
X12405	BOOL	W	Reset the power fail signal
X12406	BOOL	W	Set fixed tare weight D415 as tare
X12407	BOOL	W	Store the current gross weight in the fixed tare memory (D415)
X12409	BOOL	W	Reset error B1555 = 0.
B1552	SINT	R	Exponent Number of decimal places Example: 1.23 is displayed Exponent: 2
B1553	SINT	R	Weight unit 1 = mg, 2 = g, 3 = kg, 4 = t, 5 = lb, 9 = oz
B1554	SINT	R	Verification interval (for multi-interval/multi-range = d1 or e1)
B1555	BYTE	R	Last weighing point error, see PR 5900 operating instructions.
B1556	BYTE	R	Higher byte of product code (0x59)
B1557	BYTE	R	Lower byte of product code (0x00)
B1558	BYTE	R	Major part of version number (1.0)
B1559	BYTE	BYTE	Minor part of version number (1.0)
B1567	BYTE	BYTE	ADC status

SPM address	Data type	R/W	Function
D390	UDINT	R	Serial number (board number)
W782	INT	R	Counter will be increased for every measured value.
D392	DINT	R	Current gross weight
D393	DINT	R	Current net weight
D394	DINT	R	Current tare weight
D395	DINT	R	Current gross/net weight selected with X12360
D396	DINT	R	Gross value with magnifier 100 (centi d)
D397	DINT	R	Tare value with magnifier 100 (centi d)
D398	DINT	R	Max weight (FSD = Full Scale Deflection)
D399	DINT	R	Min weight
D400	DINT	R	Report: Gross weight
D401	DINT	R	Report: Net weight
D402	DINT	R	Report: Tare weight
D403	DINT	R	Report: Sequence number
B1616	BYTE	R	Alibi status, see Chapter 8.11 .
D405	DINT	R	Report: Date
D406	DINT	R	Report: Time
D408	DINT	R/W	Limit 1 on
D409	DINT	R/W	Limit 1 off
D410	DINT	R/W	Limit 2 on
D411	DINT	R/W	Limit 2 off
D412	DINT	R/W	Limit 3 on
D413	DINT	R/W	Limit 3 off
D415	DINT	R/W	Preset tare memory (X12406, X12407)
B1664	BYTE		Indicator status 1
X13312	BOOL	R	The application is ready.
X13313	BOOL	R	Weighing or check weighing application is active.
X13314	BOOL	R/W	Dialog window is active.
X13315	BOOL	R/W	Start printing. This corresponds to pressing the Print key.
X13316	BOOL	R/W	It is not possible to exit weighing, check weighing or terminal function because the lock is active.

SPM address	Data type	R/W	Function
B1665	BYTE		Indicator status 2
X13321	BOOL	R	Weighing point is "W&M."
X13322	BOOL	R	The weighing point is a user-defined scale or a liquid counter. This WP is selected and is visible on the display.
X13324	BOOL	R	
B1666	BYTE		Indicator status: Bar graph of statuses
X13328	BOOL	R	0...-Tolerance
X13329	BOOL	R	-Tolerance...+Tolerance
X13330	BOOL	R	+Tolerance...Max
X13331	BOOL	R	Outside tolerance
D417...421	DINT		Terminal function "dsp1" (line 1)
B1668...1671	BYTE [20]	R/W	Part 1
B1672...1675	BYTE [20]	R/W	Part 2
B1676...1679	BYTE [20]	R/W	Part 3
B1680...1683	BYTE [20]	R/W	Part 4
B1684...1687	BYTE [20]	R/W	Part 5
D422...426	DINT		Terminal function "dsp2" (line 2)
B1688...1691	BYTE [20]	R/W	Part 1
B1692...1695	BYTE [20]	R/W	Part 2
B1696...1699	BYTE [20]	R/W	Part 3
B1700...1703	BYTE [20]	R/W	Part 4
B1704...1707	BYTE [20]	R/W	Part 5
D427...431	DINT		Dialog text 1
B1708...1711	BYTE [20]	R/W	Part 1
B1712...1715	BYTE [20]	R/W	Part 2
B1716...1719	BYTE [20]	R/W	Part 3
B1720...1723	BYTE [20]	R/W	Part 4
B1724...1727	BYTE [20]	R/W	Part 5
D432...436	DINT		Dialog text 2
B1728...1731	BYTE [20]	R/W	Part 1
B1732...1735	BYTE [20]	R/W	Part 2
B1736...1739	BYTE [20]	R/W	Part 3
B1740...1743	BYTE [20]	R/W	Part 4
B1744...1747	BYTE [20]	R/W	Part 5
D437...441	DINT		Dialog text 3
B1748...1751	BYTE [20]	R/W	Part 1
B1752...1755	BYTE [20]	R/W	Part 2
B1756...1759	BYTE [20]	R/W	Part 3
B1760...1763	BYTE [20]	R/W	Part 4
B1764...1767	BYTE [20]	R/W	Part 5

SPM address	Data type	R/W	Function
D442...446	DINT		Dialog text 4
B1768...1771	BYTE [20]	R/W	Part 1
B1772...1775	BYTE [20]	R/W	Part 2
B1776...1779	BYTE [20]	R/W	Part 3
B1780...1783	BYTE [20]	R/W	Part 4
B1784...1787	BYTE [20]	R/W	Part 5
D447...451	DINT		Dialog text 5
B1788...1791	BYTE [20]	R/W	Part 1
B1792...1795	BYTE [20]	R/W	Part 2
B1796...1799	BYTE [20]	R/W	Part 3
B1800...1803	BYTE [20]	R/W	Part 4
B1804...1807	BYTE [20]	R/W	Part 5
D452...456	DINT		Dialog text 6
B1808...1811	BYTE [20]	R/W	Part 1
B1812...1815	BYTE [20]	R/W	Part 2
B1816...1819	BYTE [20]	R/W	Part 3
B1820...1823	BYTE [20]	R/W	Part 4
B1824...1827	BYTE [20]	R/W	Part 5
D457...461	DINT		Dialog text 7
B1828...1831	BYTE [20]	R/W	Part 1
B1832...1835	BYTE [20]	R/W	Part 2
B1836...1839	BYTE [20]	R/W	Part 3
B1840...1843	BYTE [20]	R/W	Part 4
B1844...1847	BYTE [20]	R/W	Part 5
D462...466	DINT		Dialog text 8
B1848...1851	BYTE [20]	R/W	Part 1
B1852...1855	BYTE [20]	R/W	Part 2
B1856...1859	BYTE [20]	R/W	Part 3
B1860...1863	BYTE [20]	R/W	Part 4
B1864...1867	BYTE [20]	R/W	Part 5
D467...471	DINT		Dialog text 9
B1868...1871	BYTE [20]	R/W	Part 1
B1872...1875	BYTE [20]	R/W	Part 2
B1876...1879	BYTE [20]	R/W	Part 3
B1880...1883	BYTE [20]	R/W	Part 4
B1884...1887	BYTE [20]	R/W	Part 5
D472...476	DINT		Dialog text 10
B1888...1891	BYTE [20]	R/W	Part 1
B1892...1895	BYTE [20]	R/W	Part 2
B1896...1899	BYTE [20]	R/W	Part 3
B1900...1903	BYTE [20]	R/W	Part 4
B1904...1907	BYTE [20]	R/W	Part 5
D478	DINT	R/W	Terminal function: Variable "termfun" Values for "termfun" in accordance with Chapter 6.5 .

SPM address	Data type	R/W	Function
D479	DINT	R/W	Terminal status: Variable "termstat" Values for "termstat" in accordance with Chapter 6.5.
D480	DINT	R/W	Free number 1 for printout "Num_1," see Chapter 10.3.
D481	DINT	R/W	Free number 2 for printout "Num_2," see Chapter 10.3.
D482	DINT	R/W	Free number 3 for printout "Num_3," see Chapter 10.3.
D483	DINT	R/W	Terminal function "editint": Input of integers
D484	DINT	R/W	Variable "repofun": Value > 0 triggers the print order remotely for the current application (weighing or check weighing) with the number of printouts according to the configuration.
D485	DINT	R	Variable "repostat": Request print status remotely (-1 = Error, 0 = OK) or value > 0 triggers the print order remotely for the current application (weighing or check weighing) with the number of printouts = value.
D487	DINT	R/W	Terminal function "editreal": Input of floating point numbers
D488	DINT	R/W	Terminal function "editwgt": Input of weight value
X15760	BOOL	R	Tare status for printout: Scale tared/not tared
B1976	BYTE [12]	R/W	Terminal function "edit_wgt_w": Weight value
D498	DINT	R/W	Check weighing: Set point min.
D499	DINT	R/W	Check weighing: Set point
D500	DINT	R/W	Check weighing: Set point max.
X16036	BOOL	R	Binary weight output, Bit 12 (MSB)
X16037	BOOL	R	Binary weight output, Bit 11
X16038	BOOL	R	Binary weight output, Bit 10
X16039	BOOL	R	Binary weight output, Bit 9
X16040	BOOL	R	Binary weight output, Bit 8
X16041	BOOL	R	Binary weight output, Bit 7
X16042	BOOL	R	Binary weight output, Bit 6
X16043	BOOL	R	Binary weight output, Bit 5
X16044	BOOL	R	Binary weight output, Bit 4
X16045	BOOL	R	Binary weight output, Bit 3
X16046	BOOL	R	Binary weight output, Bit 2
X16047	BOOL	R	Binary weight output, Bit 1 (LSB)

Note:

Freely assignable SPM addresses D508...D511, see Chapter [8.10](#).

Note:

The system variables (e.g. ST_WGT_A) for communication via OPC are described in operating instructions PR 1792 (Chapter 4 + 5).

8.8 Digital and analog inputs and outputs

SPM address	Data type	R/W	Function
D512	DINT	R	Digital input 1 (option-1)
D513	DINT	R	Digital input 2 (option-2)
D514	DINT	R	Digital input 3 (built-in)
D516	DINT	R/W	Digital output 1 (option-1)
D517	DINT	R/W	Digital output 2 (option-2)
D518	DINT	R/W	Digital output 3 (built-in)
D520	DINT	R	Analog input 1 (option-1)
D521	DINT	R	Analog input 2 (option-2)
D523	DINT	R/W	Analog output 1 (option-1)
D524	DINT	R/W	Analog output 2 (option-2)

8.9 ModBus TCP modules

SPM address	Data type	R/W	Function
W1052	UINT	R	Input module 1
X16832...16847	BOOL	R	Digital inputs 1...16
W1053	UINT	R	Input module 2
X16848...16863	BOOL	R	Digital inputs 1...16
W1054	UINT	R	Input module 3
X16864...16879	BOOL	R	Digital inputs 1...16
W1055	UINT	R	Input module 4
X16880...16895	BOOL	R	Digital inputs 1...16
W1056	UINT	R	Input module 5
X16896...16903	BOOL	R	Digital inputs 1...8
W1057	UINT	R	Input module 6
X16912...16919	BOOL	R	Digital inputs 1...8
W1058	UINT	R	Input module 7
X16928...16935	BOOL	R	Digital inputs 1...8

SPM address	Data type	R/W	Function
W1059	UINT	R	Input module 8
X16944...16951	BOOL	R	Digital inputs 1..8
W1062	UINT	R/W	Output module 1
X16992...17007	BOOL	R/W	Digital outputs 1..16
W1063	UINT	R/W	Output module 2
X17008...17023	BOOL	R/W	Digital outputs 1..16
W1064	UINT	R/W	Output module 3
X17024...17039	BOOL	R/W	Digital outputs 1..16
W1065	UINT	R/W	Output module 4
X17040...17055	BOOL	R/W	Digital outputs 1..16
W1066	UINT	R/W	Output module 5-0
X17056...17071	BOOL	R/W	Digital outputs 1..16
W1067	UINT	R/W	Output module 5-1
X17072...17087	BOOL	R/W	Digital outputs 17..32
W1068	UINT	R/W	Output module 5-2
X17100...17103	BOOL	R/W	Digital outputs 33..36
W1069	UINT	R/W	Output module 6-0
X17104...17119	BOOL	R/W	Digital outputs 1..16
W1070	UINT	R/W	Output module 6-1
X17120...17135	BOOL	R/W	Digital outputs 17..32
W1071	UINT	R/W	Output module 6-2
X17148...17151	BOOL	R/W	Digital outputs 33..36
W1072	UINT	R/W	Output module 7-0
X17152...17167	BOOL	R/W	Digital outputs 1..16
W1073	UINT	R/W	Output module 7-1
X17168...17183	BOOL	R/W	Digital outputs 17..32
W1074	UINT	R/W	Output module 7-2
X17184...17199	BOOL	R/W	Digital outputs 33..48
W1075	UINT	R/W	Output module 7-3
X17212...17215	BOOL	R/W	Digital outputs 49..52
W1076	UINT	R/W	Output module 8-0
X17216...17231	BOOL	R/W	Digital outputs 1..16
W1077	UINT	R/W	Output module 8-1
X17232...17247	BOOL	R/W	Digital outputs 17..32
W1078	UINT	R/W	Output module 8-2
X17248...17263	BOOL	R/W	Digital outputs 33..48
W1079	UINT	R/W	Output module 8-3
X17276...17279	BOOL	R/W	Digital outputs 49..52

8.10 Freely assigned ranges

Weighing point A

%ML	%MD	%MW	%MB	%MX							
				0	1	2	3	4	5	6	7
62	124	248	496	3968	3969	3970	3971	3972	3973	3974	3975
			497	3976	3977	3978	3979	3980	3981	3982	3983
		249	498	3984	3985	3986	3987	3988	3989	3990	3991
			499	3992	3993	3994	3995	3996	3997	3998	3999
	125	250	500	4000	4001	4002	4003	4004	4005	4006	4007
			501	4008	4009	4010	4011	4012	4013	4014	4015
		251	502	4016	4017	4018	4019	4020	4021	4022	4023
			503	4024	4025	4026	4027	4028	4029	4030	4031
63	126	252	504	4032	4033	4034	4035	4036	4037	4038	4039
			505	4040	4041	4042	4043	4044	4045	4046	4047
		253	506	4048	4049	4050	4051	4052	4053	4054	4055
			507	4056	4057	4058	4059	4060	4061	4062	4063
	127	254	508	4064	4065	4066	4067	4068	4069	4070	4071
			509	4072	4073	4074	4075	4076	4077	4078	4079
		255	510	4080	4081	4082	4083	4084	4085	4086	4087
			511	4088	4089	4090	4091	4092	4093	4094	4095

Weighing point B

%ML	%MD	%MW	%MB	%MX							
				0	1	2	3	4	5	6	7
126	252	504	1008	8064	8065	8066	8067	8068	8069	8070	8071
			1009	8072	8073	8074	8075	8076	8077	8078	8079
		505	1010	8080	8081	8082	8083	8084	8085	8086	8087
			1011	8088	8089	8090	8091	8092	8093	8094	8095
	253	506	1012	8096	8097	8098	8099	8100	8101	8102	8103
			1013	8104	8105	8106	8107	8108	8109	8110	8111
		507	1014	8112	8113	8114	8115	8116	8117	8118	8119
			1015	8120	8121	8122	8123	8124	8125	8126	8127
127	254	508	1016	8128	8129	8130	8131	8132	8133	8134	8135
			1017	8136	8137	8138	8139	8140	8141	8142	8143
		509	1018	8144	8145	8146	8147	8148	8149	8150	8151
			1019	8152	8153	8154	8155	8156	8157	8158	8159
	255	510	1020	8160	8161	8162	8163	8164	8165	8166	8167
			1021	8168	8169	8170	8171	8172	8173	8174	8175
		511	1022	8176	8177	8178	8179	8180	8181	8182	8183
			1023	8184	8185	8186	8187	8188	8189	8190	8191

Weighing point C

%ML	%MD	%MW	%MB	%MX							
				0	1	2	3	4	5	6	7
190	380	760	1520	12160	12161	12162	12163	12164	12165	12166	12167
			1521	12168	12169	12170	12171	12172	12173	12174	12175
		761	1522	12176	12177	12178	12179	12180	12181	12182	12183
			1523	12184	12185	12186	12187	12188	12189	12190	12191
	381	762	1524	12192	12193	12194	12195	12196	12197	12198	12199
			1525	12200	12201	12202	12203	12204	12205	12206	12207
		763	1526	12208	12209	12210	12211	12212	12213	12214	12215
			1527	12216	12217	12218	12219	12220	12221	12222	12223
191	382	764	1528	12224	12225	12226	12227	12228	12229	12230	12231
			1529	12232	12233	12234	12235	12236	12237	12238	12239
		765	1530	12240	12241	12242	12243	12244	12245	12246	12247
			1531	12248	12249	12250	12251	12252	12253	12254	12255
	383	766	1532	12256	12257	12258	12259	12260	12261	12262	12263
			1533	12264	12265	12266	12267	12268	12269	12270	12271
		767	1534	12272	12273	12274	12275	12276	12277	12278	12279
			1535	12280	12281	12282	12283	12284	12285	12286	12287

Weighing point D

%ML	%MD	%MW	%MB	%MX									
				0	1	2	3	4	5	6	7		
254	508	1016	2032	16256	16257	16258	16259	16260	16261	16262	16263		
			2033	16264	16265	16266	16267	16268	16269	16270	16271		
		1017	2034	16272	16273	16274	16275	16276	16277	16278	16279		
			2035	16280	16281	16282	16283	16284	16285	16286	16287		
	509	1018	2036	16288	16289	16290	16291	16292	16293	16294	16295		
			2037	16296	16297	16298	16299	16300	16301	16302	16303		
		1019	2038	16304	16305	16306	16307	16308	16309	16310	16311		
			2039	16312	16313	16314	16315	16316	16317	16318	16319		
			510	1020	2040	16320	16321	16322	16323	16324	16325	16326	16327
					2041	16328	16329	16330	16331	16332	16333	16334	16335
1021	2042	16336	16337	16338	16339	16340	16341	16342	16343				
	2043	16344	16345	16346	16347	16348	16349	16350	16351				
	511	1022	2044	16352	16353	16354	16355	16356	16357	16358	16359		
			2045	16360	16361	16362	16363	16364	16365	16366	16367		
1023	2046	16368	16369	16370	16371	16372	16373	16374	16375				
	2047	16376	16377	16378	16379	16380	16381	16382	16383				

8.11 Status of the Alibi memory

Value	Function
0	No error
1	License for Alibi memory has not been entered.
4	Some of the weights had errors, e.g. overload.
5	Gross or net had no standstill.
6	Some data has been modified before storing.
7	Not enough old records to remove.
8	Alibi memory is full and [Tidy up records] is disabled.
9	Alibi memory server has error.
10	Alibi memory has error.

9 Tilt correction

9.1 General

This function is needed in order to eliminate reproducible external influences that might adversely affect accurate weighing (e.g.: system components that cause tilting movements).

The tilting movement is detected by a rotary angle sensor and sent to the scale by means of an analog signal (range 0–10 V, 0–20 mA).

A calibration must be performed over the entire range of the tilting movement to detect the systematic errors. During calibration, the analog values for each angle are automatically written to a correction table, together with the associated weight values. The table can contain up to 99 values.

The following is required for working with the "tilt correction" function:

- Analog input of PR 5900/07 for connecting the rotary angle sensor
- Valid license

Example:

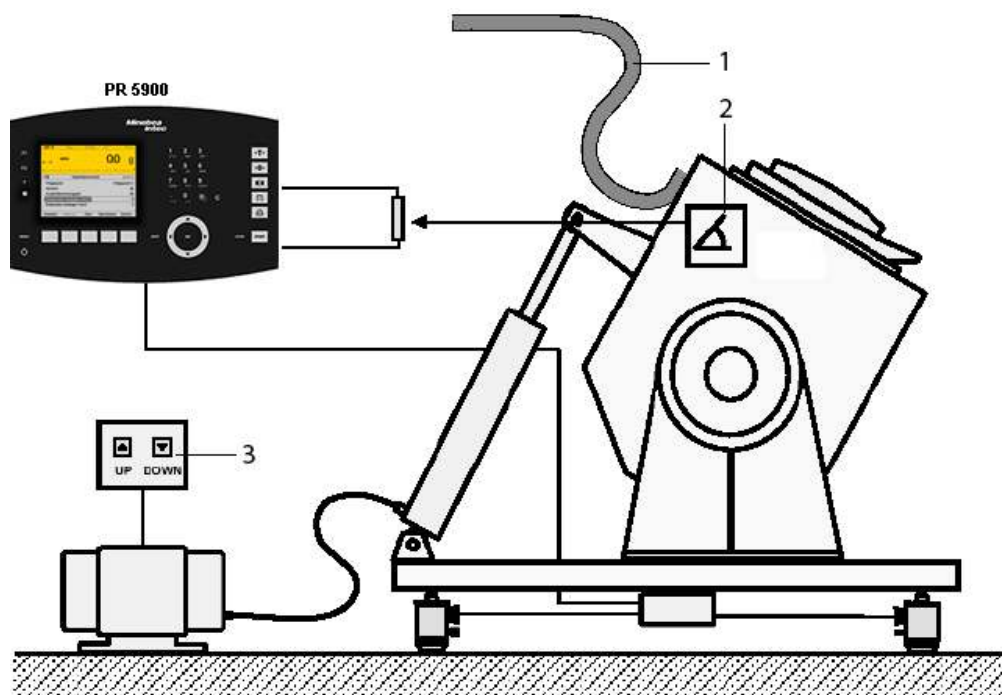

No.	Description
1	Power supply
2	Rotary angle sensor
3	Tilt control

9.2 Performing tilt correction

Note:

Tilt correction can only be performed if the "Supervisor" or "Administrator" user is logged in.

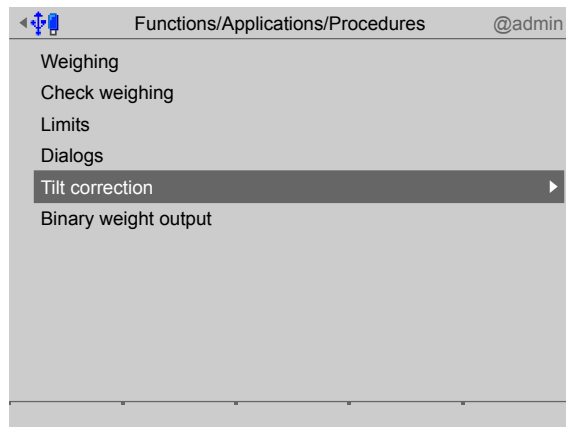

1. Select and confirm [Tilt correction] using the cursor.

▷ A selection window is displayed.

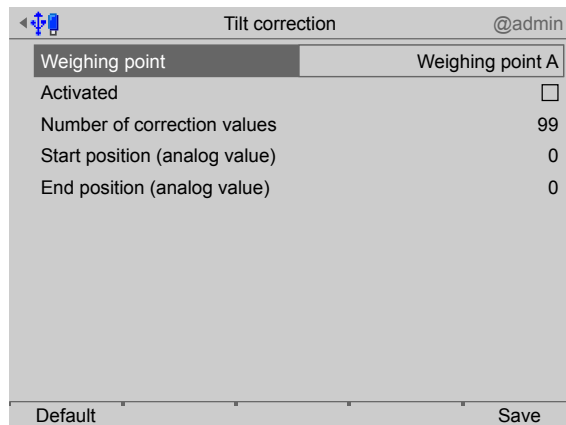

2. Select and confirm the appropriate weighing point.
3. Check the box to activate the correction. The weight display bar graph then appears to make configuration easier.

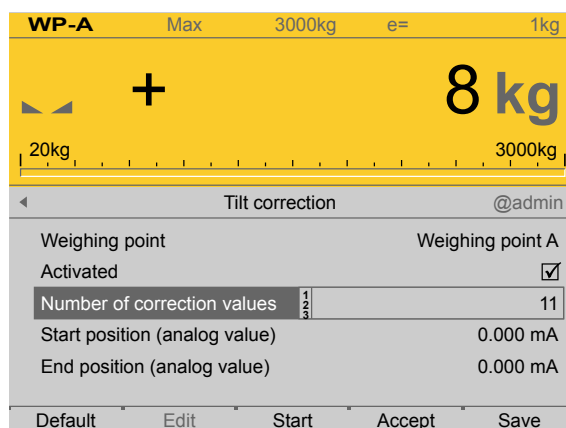

- Use the keyboard to enter the number of correction values (in this case: 11).

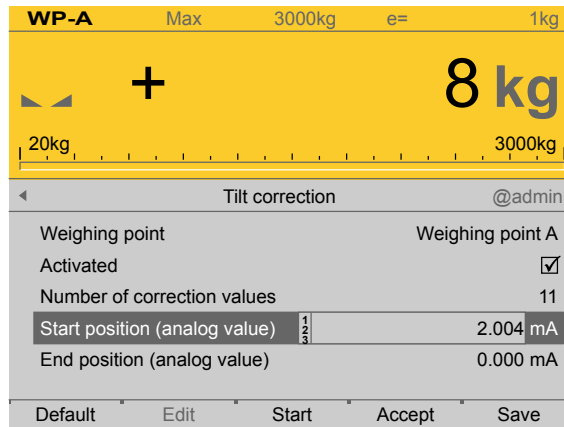

Note:

The positions must be entered with an empty vessel.

- Move the vessel to the start position (max. tendency to tilt on one side).
- Press the [Accept] soft key to save the start position.

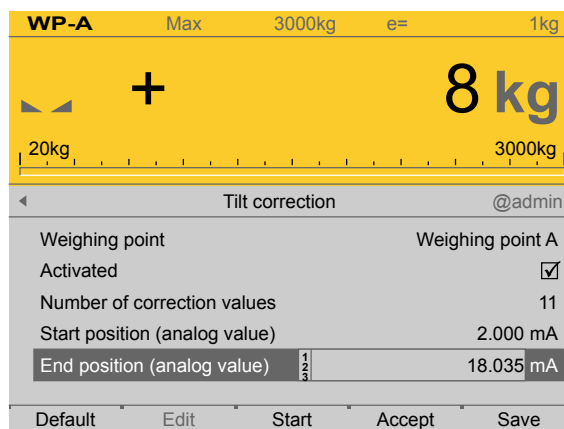

- Move the vessel to the end position (max. tendency to tilt on the other side).
- Press the [Accept] soft key to save the end position.



- Return the vessel to the start position.

10. Press the [Start] soft key to start the calibration.
11. Now move the vessel to the end position so slowly that the standstill indicator remains activated, in order to be able to record the weight values. If applicable, reduce the measurement time or adjust the digital filter.

Note:

Start and end positions can also be entered manually if they are known.

If the calibration process was canceled or not all the values were initialized or recorded in the table, because no standstill was achieved, a message will be displayed briefly.

12. If applicable, press the [Delete] soft key to delete the correction table.
13. Press the [Edit] soft key to change the corresponding values.
 - ▷ The correction table is displayed.

ID	Weight
ID 1	3 kg
ID 2	37 kg
ID 3	70 kg
ID 4	103 kg
ID 5	0 kg
ID 6	137 kg
ID 7	170 kg
ID 8	203 kg
ID 9	237 kg
ID 10	270 kg
ID 11	0 kg

Save

14. Select the relevant values, make plausible changes using the keyboard and confirm.
15. Finally, press the [Save] soft key to save the settings.
 - ▷ If applicable, a prompt window is displayed.

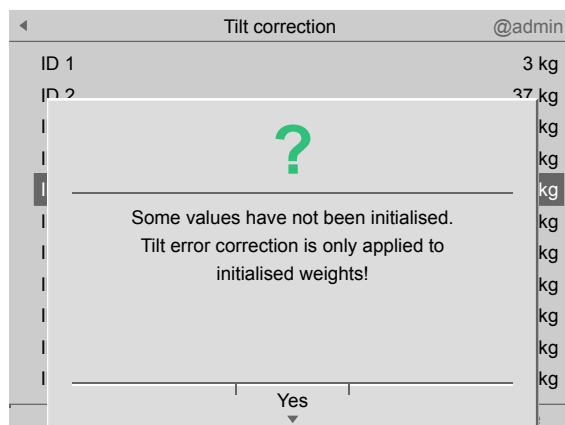

16. Press the [Yes] soft key.
17. Finally, press the [Save] soft key to save the settings.
or
18. press the **ESC/EXIT** key to exit the menu.

- ▷ A prompt window is displayed.

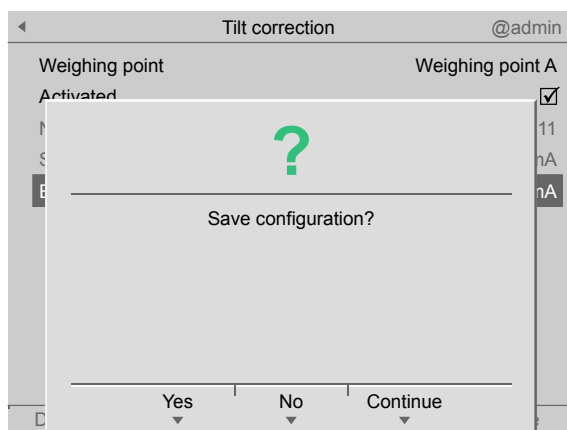

19. Press the [Yes] soft key to save the settings.

Note:

If the approved angular range of the rotary encoder is exceeded, no correction is made. Only the measured weight values are displayed.

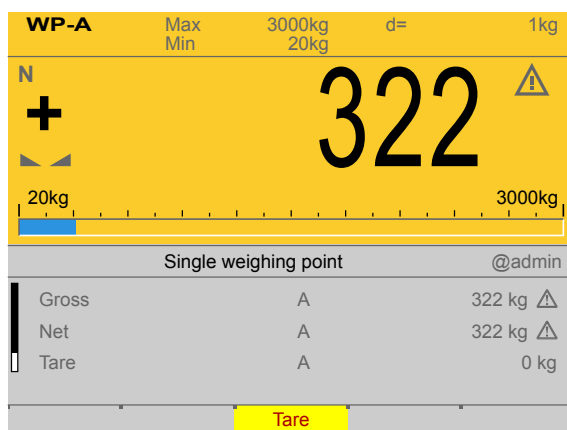

20. E.g., select and confirm [Weighing] in the Application menu using the cursor.
21. Perform the weighing operation.
 - ▷ The weight value is displayed without weight unit and with warning symbol, i.e.: Tilt correction has been performed during this weighing operation.

10 Printouts

10.1 General notes

The following printouts are available in PR 5900 using the Basic application:

- Device configuration data, see PR 5900 operating instructions
- Basic configuration data, see Chapter [10.2](#)
- Tickets and labels NLE (NiceLabelExpress), see Chapter [10.3.2](#), [10.3.3](#)
- Tickets, see Chapter [10.3](#)

10.2 Basic-Configuration data

The option is available to print out the Basicconfiguration data. The configuration data is output to the printer configured in the [System setup] - [Connected devices] system menu under "General Devices" (see PR 5900 operating instructions).

The print width is limited to 39 characters per line. This means a ticket printer can also be used. When printing the first line, the program checks whether printing is possible. In the event of a printer failure during printing, a time-out of approximately 3 s is active for each print line.

The printout cannot be changed using "NiceLabelExpress." The printout reflects the current data status.

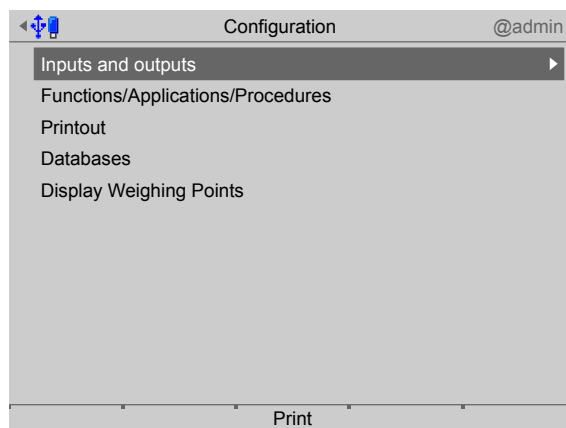

- Press the [Print] soft key or the  button to print out the configuration.

10.3 Tickets

10.3.1 General notes

The configuration for tickets is performed in the [Configuration] - [Printout] - [Print format x] menu, see Chapter [5.4.11](#).

To start printing, the application must be started.

A printout can be initiated by the following signals:

- Press the  or  key
- Activating the digital input

- Signal via fieldbus (repofun)
- Signal via DDE/OPC (repofun)

If the weight value is within an inadmissible range (concerns mainly legal-for-trade devices), no printout is generated. If the weight value is permissible, the ticket is printed as configured.

The data for printing can also be read via DDE/OPC communication or fieldbus communication. Refer to the relevant chapters for further details.

10.3.2 Tickets and labels without NLE (NiceLabelExpress)

Example:

Customer		HBB
Order number		23456789
Sequence number		6
Date		2012-10-22
Time		16:23:54
Gross	A	<2516.7 g>
Net	A	<2516.7 g>
Tare	A	<0.0 g>

10.3.3 Tickets and labels with NLE (NiceLabelExpress)

Tickets can be printed directly or using NLE. The names of the NLE files are:

- for weighing: "WGT.LBL"
- For check weighing: "CHECK.LBL"

To create a user-defined ticket, the "NiceLabelExpress" program is required. All variable contents (e.g., weights) and invariable texts (e.g., "sequence number") for these tickets are transmitted to the ticket using variables. In many cases this enables the user to create language adjustments for NLE with "PoEdit". In this case, "NiceLabelExpress" does not need to be called up. A fixed structure of variables from the application is provided for "NiceLabelExpress."

If an NLE file is loaded into the device, it will always be printed using NiceLabelExpress if "Use NLE" has been activated.

Variables for NLE	Data formats	Description Parameter content	Weighing	Check weighing
dates	STR10	Date	X	X
time	STR10	Time	X	X
seqnum	DINT	Sequence number	X	X
wp_id	STR2	Weighing point "A", "B"	X	X
gross	WEIGHT	Gross weight	X	X
net	WEIGHT	Net weight	X	X
tare	WEIGHT	Tare weight	X	X

Variables for NLE	Data formats	Description Parameter content	Weighing	Check weighing
actual	WEIGHT	If tared: net, otherwise gross	X	X
mode	STR20	Text tgross or tnet, corresponding to actual	X	X
scale	STR20	Identification name of the device	X	X
text1...10	STR20	Free text via communication or terminal function	X	X
editstr	STR20	Text to be edited via communication or terminal function	X	X
editint	DINT	Integer to be edited via communication or terminal function	X	X
editreal	REAL	Float to be edited via communication or terminal function	X	X
editwgt	WEIGHT	Weight to be edited via communication or terminal function	X	X
wp_id	STR1	Scale ID	X	X
term	STR20	Terminal name	X	X
ldGrp	STR21	Application database: Field key name, e.g.: Customer name	X	X
ld1	STR21	Application database: Field name 1, e.g.: Place of delivery	X	X
ld2	STR21	Application database: Field name 2, e.g.: Area Code	X	X
ld3	STR21	Application database: Field name 3, e.g.: Town	X	X
ld4	STR21	Application database: Field name 4, e.g.: Street	X	X
ld5	STR21	Application database: Field name 5, e.g.: Phone	X	X
ld6	STR21	Application database: Field name 6, e.g.: Fax	X	X
num1	DINT	Free number to be set via communication	X	X
num2	DINT	Free number to be set via communication	X	X
num3	DINT	Free number to be set via communication	X	X
setpmin	REAL	Check weighing: Set point min.		X
setp	REAL	Check weighing: Set point		X
setpmax	REAL	Check weighing: Set point max.		X
tterm	STR20	Prompt text, terminal name	X	X

Variables for NLE	Data formats	Description Parameter content	Weighing	Check weighing
thead	STR30	Heading for printout	X	X
tseq	STR20	Prompt text, sequence number	X	X
tdate	STR20	Prompt text, date	X	X
ttime	STR20	Prompt text, time	X	X
tgross	STR20	Prompt text, gross	X	X
tnet	STR20	Prompt text, net	X	X
ttare	STR20	Prompt text, tare	X	X
twp	STR20	Prompt text, scale ID	X	X
tmode	STR20	Prompt text, text tgross or tnet, corresponding to actual	X	X
ttext1...10	STR20	Prompt text, free text 1...10	X	X
tnum1	STR20	Prompt text, free number 1	X	X
tnum2	STR20	Prompt text, free number 2	X	X
tnum3	STR20	Prompt text, free number 3	X	X
tactual	STR20	Prompt text, actual	X	X
twgt	STR20	Prompt text for weight to be edited	X	X
twgtA	STR20	Prompt text for weight WP A to be edited	X	X
twgtB	STR20	Prompt text for weight WP B to be edited	X	X
twgtC	STR20	Prompt text for weight WP C to be edited	X	X
twgtD	STR20	Prompt text for weight WP D to be edited	X	X
tstr	STR20	Prompt text for text to be edited	X	X
tint	STR20	Prompt text for integer to be edited	X	X
treal	STR20	Prompt text for float to be edited	X	X

Published by
Minebea Intec GmbH | Meiendorfer Strasse 205 A | 22145 Hamburg, Germany
Phone: +49.40.67960.303 | Email: info@minebea-intec.com
www.minebea-intec.com

