

***Minebea***

**CC-Link**

***DIGITAL PEAK HOLDER***

***CC-Link Interface***

***CSD-709-73***

**Instruction Manual**



## Introduction

Thank you for adopting our CSD-709-73 digital peak holder with CC-Link Interface. This instruction manual describes how to operate the device and presents other noteworthy points. Note that handling or operating the device incorrectly may result in malfunctions. Read this manual thoroughly before use to ensure safety and achieve optimal results.

Keep this instruction manual in a location where it is readily accessible to end users.

Please note that this instruction manual is intended for use by engineers.

Readers of this manual must have a basic understanding of programmable logic controllers (PLC) and the CC-Link Interface.

## Pictograms and Conventions Used in This Manual

This manual uses the following pictograms to indicate actions to avoid at all times, aspects requiring caution, and other noteworthy matters.

Be sure to read the descriptions provided alongside these pictograms.



### **WARNING**

This indicates circumstances in which incorrect handling may result in death or serious injury to users.  
Avoid the actions described here at all times.



### **CAUTION**

This indicates circumstances in which incorrect handling may result in injury to users or damage to property.



This indicates operating or procedural precautions or restrictions.  
Always read the details included here to avoid malfunctioning.

## Positioning of This Document

This instruction manual describes connection and usage according to the specifications of the CC-Link Interface, an accessory for the CSD-709.

For information on other product functions, basic handling instructions, and precautions, refer to the CSD-709 manual.

CSD-709 Instruction Manual (DRW No. EN294-1742)

For information on PLC programming and CC-Link, refer to the instruction manuals for the PLC and CC-Link Interface for the PLC.

- CC-Link is an abbreviation of "Control & Communication Link."
- This equipment is compatible with CSP+ (CC-Link Family System Profile Plus).

Download CSP+ files from the following URL if necessary:

<http://www.minebea-mcd.com/product/i-amp/csd709.html>

For details of CSP+, visit the Mitsubishi Electric Corporation website.

# Revision History

Date	Manual No.	Revision reason (details)
2017/4	DRW. No. EN294-1701	First edition, Ver. 1.000

# Contents

<b>Introduction</b> .....	<b>I</b>
<b>Pictograms and Conventions Used in This Manual</b> .....	<b>I</b>
<b>Positioning of This Document</b> .....	<b>II</b>
<b>Revision History</b> .....	<b>III</b>
<b>1. Overview</b> .....	<b>1</b>
1-1. Features.....	1
<b>2. Nomenclatures and Functions</b> .....	<b>2</b>
2-1. Rear panel CC-Link Interface section .....	2
<b>3. Wiring</b> .....	<b>3</b>
3-1. Communication connector pin configuration .....	3
3-2. Wiring precautions .....	3
<b>4. Configuring CC-Link Communication</b> .....	<b>4</b>
4-1. Switching to function mode.....	4
4-2. CC-Link setting items .....	4
<b>5. Description of PLC Memory</b> .....	<b>6</b>
5-1. Addresses.....	6
5-2. Address map .....	7
<b>6. Calibration</b> .....	<b>29</b>
6-1. Switching to communication calibration mode .....	30
6-2. Setting unit weight .....	30
6-3. Setting measuring weight .....	31
6-4. Setting weight mass .....	31
6-5. Confirming zero point stabilization .....	32
6-6. Registering zero point from measurement .....	32
6-7. Entering load cell output voltage values to register zero point.....	33
6-8. Confirming span point stabilization.....	34
6-9. Registering span point from measurement .....	34
6-10. Entering load cell output voltage values to register span point .....	35
6-11. Ending calibration .....	36
6-12. Forced termination of calibration .....	36
<b>7. Operating Instructions</b> .....	<b>37</b>
7-1. Writing setting values .....	37
7-2. Reading out/writing using general commands .....	37

7-3.	Preparing for communication .....	38
7-4.	Error status and reset request flag.....	39
7-5.	Normal CPU operation signal .....	39
<b>8.</b>	<b><i>Interface Specifications</i></b> .....	<b>40</b>
8-1.	CC-Link Interface specifications .....	40
8-2.	Accessories .....	40





## **1. Overview**

This equipment is a remote device station of CC-Link Ver 1.10.  
The master station of CC-Link Ver. 1.10 can be connected.

### **1-1. Features**

The main features of CSD-709-73 are as follows:

- (1) Can reduce PLC program volume, because this equipment can be controlled by PLC remote I/O and registering.
- (2) Can reduce wiring with the PLC.

## 2. Nomenclatures and Functions

### 2-1. Rear panel CC-Link Interface section

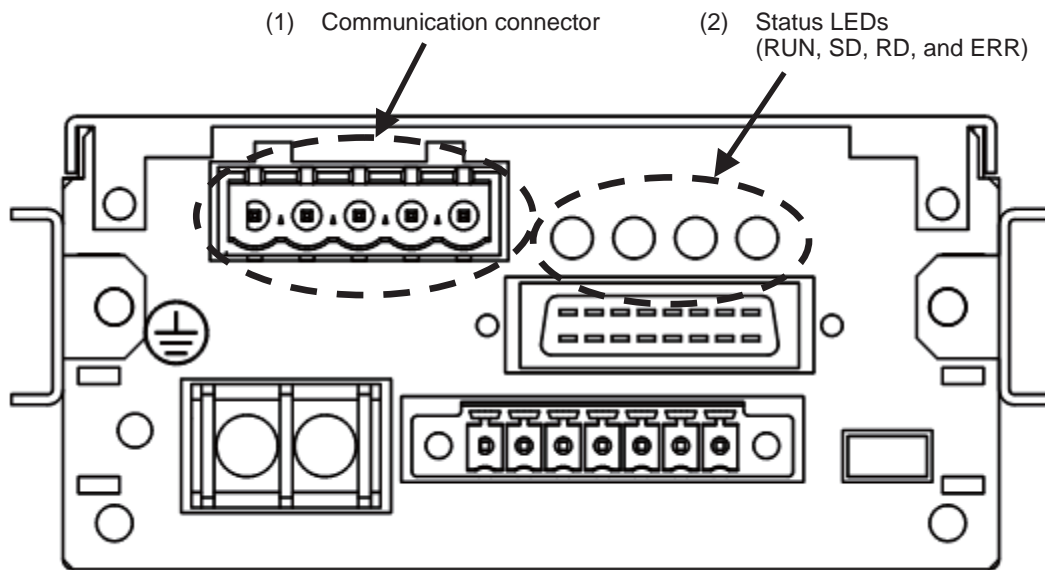

#### (1) Connector board of the communication connector

This is the CC-Link Interface connector board.

The pin configuration of the connector board is as follows:

Pin No.	Signal	Details
1	DA	Signal line DA side
2	DB	Signal line DB side
3	DG	Signal line ground
4	SLD	Shield
5	FG	Frame ground

\* Included compatible plug for the connector board of the CC-Link connector:  
MSTB 2,5/5-ST-5,08 AU (manufactured by Phoenix Contact)

\* SLD and FG are connected internally.

\* Insulated by photocoupler from internal circuit.

#### (2) Status LEDs

Consists of four LEDs that indicate communication status.

LED name	On	Off	Flashing
RUN	• Normal	• Reset in progress • Communication not possible	—
SD	• Sending	—	—
RD	• Receiving	—	—
ERR	• Setting error • CRC error • Failure	• Normal	• When settings change

## 3. Wiring

### 3-1. Communication connector pin configuration

See 2-1 "Rear Panel (1) Connector board of the communication connector."

### 3-2. Wiring precautions

- Always turn off power before wiring.
- Do not supply AC power until all installation work is complete. There is no ON/OFF switch on the unit itself.
- The connector board on the rear panel of this equipment is a resin component. Do not drop or subject to strong impact.
- The stripped cable tip length is 6 mm.
- The terminal screw tightening torque on the connector board is 0.6 N·m.
- Keep cables that are connected to the unit as far as possible from sources of noise, such as power supply lines or control interfaces.
- Always ground the device. Ground based on Type D single grounding. Do not share grounds with the power supply system.
- For CC-Link cable connections, use shielded twisted pair cable wire (dedicated cable for CC-link) and connect the shield to the connector board SLD or F.G. terminal.





- **Connect terminating resistor to the CC-Link connector farthest from the PLC.**
- **Use a dedicated cable for CC-link as the connecting cable.**
- **For information on communication speed and cable length, refer to "Construction and specifications of network system" in the latest edition of the CC-Link Open Field Network Cable Wiring Manual, published by CC-Link Partner Association.**

## 4. Configuring CC-Link Communication

When using the CC-Link Interface, configure the following items:

### 4-1. Switching to function mode

Switch to function mode from normal measurement mode as follows:

- 1) Press the  key.
- 2) [FUNC] is displayed. Press the  key.
- 3) Confirm the function number to be set.

For details of Function mode settings and operations, see "1.6 Basic key operations" in Instruction Manual CSD-709 (DRW No. EN294-1492).

### 4-2. CC-Link setting items

Item	Function No.	Setting Value	Details
CC-Link - Number of shared stations	F-84	0	1 station shared
		1	2 stations shared
		●2	4 stations shared
CC-Link - Station number	F-85	01~64 ●01	01~64 when F-84=0 01~63 when F-84=1 01~61 when F-84=2
CC-Link - Baud rate	F-86	●0	156 kbps
		1	625 kbps
		2	2.5 Mbps
		3	5 Mbps
		4	10 Mbps
CC-Link - 32-bit data representation method	F-87	●0	Standard binary representation
		1	Sign of most significant bit (fixed at max. 8 digits if negative)

[●] indicates default settings.

#### (1) Number of shared stations setting (function F-84)

Set the number of shared stations.

Select [1 station], [2 stations], or [4 stations] in this setting.

Set to [4 stations] by default

#### (2) Station number setting (function F-85)

Set the station number.

1 station shared: Select a station number from 01 to 64.

2 stations shared: Select a station number from 01 to 63.

4 stations shared: Select a station number from 01 to 61.

This equipment can share 1, 2, or 4 stations.

\* 2 stations shared: For a station number of 01, 01 to 02 are shared.

\* 4 stations shared: For a station number of 01, 01 to 04 are shared.

Make sure that station numbers do not overlap.

Set to [01] by default

(3) Baud rate (function F-86)

Set the baud rate (unit: bps).

Select [156 k], [625 k], [2.5 M], [5 M], or [10 M].

Set to [156 k] by default

(4) Signed data representation method (function F-87)

Set how 32-bit data is represented.

Select [Standard binary representation] or [Sign of most significant bit].

Set to [Standard binary representation] by default

Data	32-bit data representation method setting	Upper 16 bit	Lower 16 bit
-1	Standard binary representation	FFFFH	FFFFH
	Sign of most significant bit	8000H	0001H
-10	Standard binary representation	FFFFH	FFF6H
	Sign of most significant bit	8000H	000AH
-99999	Standard binary representation	FFFEH	7961H
	Sign of most significant bit	8001H	869FH

## 5. Description of PLC Memory

### 5-1. Addresses

The master station allocates remote I/O (RX/RX: bit-handling register) and remote register (RWw/RWr: word-handling register) space according to the number of shared stations. In the case of this equipment, this is shown in the following table:

Type		Number of shared stations			Notes
		4 stations shared	2 stations shared	1 station shared	
Remote input		128 points	64 points	32 points	16 points are shared for I/O as system area.
Remote output		128 points	64 points	32 points	
Remote register	Master → Remote	16 points	8 points	4 points	
	Remote → Master	16 points	8 points	4 points	

Remote station register numbers allocated by the master station are shown in the following table:

Station No.	Remote input	Remote output	Remote register		Notes
			Master → Remote	Remote → Master	
0	-----	-----	-----	-----	Master station designation
1	RX0000	RY0000	RWw0000	RWr0000	
2	RX0020	RY0020	RWw0004	RWr0004	
3	RX0040	RY0040	RWw0008	RWr0008	
~	~	~	~	~	
10	RX0120	RY0120	RWw0024	RWr0024	
~	~	~	~	~	
64	RX07E0	RY07E0	RWw00FC	RWr00FC	

## 5-2. Address map

### 5-2-1. Data area

#### (1) Remote register

With 4 stations shared (master station → this equipment)			
Station	Remote register	Details	Notes
1	RWwn	(1) S0	Dedicated data area
	RWwn+1		
	RWwn+2	(1) S1	
	RWwn+3		
2	RWwn+4	(1) S2	
	RWwn+5		
	RWwn+6	(1) Calibration number	
	RWwn+7	Undefined	
3	RWwn+8		
	RWwn+9		
	RWwn+A		
4	RWwn+B	(2) General data area	
	RWwn+C		
	RWwn+D	(3) Command no. (response)	
	RWwn+E	(4) Operating mode (response)	

n: Value determined by station number setting

With 2 stations shared (master station → this equipment)			
Station	Remote register	Details	Notes
1	RWwn	(1) Calibration number (8 bit) + S0 (24 bit)	Dedicated data area
	RWwn+1		
	RWwn+2	(1) S1	
	RWwn+3		
2	RWwn+4	(2) General data area	
	RWwn+5		
	RWwn+6	(3) Command no. (response)	
	RWwn+7	(4) Operating mode (response)	

n: Value determined by station number setting

With 1 station shared (master station → this equipment)			
Station	Remote register	Details	Notes
1	RWwn	Undefined	
	RWwn+1		
	RWwn+2		
	RWwn+3		

n: Value determined by station number setting



- Specify internal RAM as the storage destination if you change setting values constantly and EEPROM rewriting may exceed 1 million cycles.
- A/D sampling speed declines temporarily as setting values are rewritten when the storage destination for setting values is EEPROM. Thus, do not change setting values during measurement. If you change setting values during measurement, specify internal RAM as the storage destination.

1) Dedicated data area (4 or 2 stations)

Setting values are set in each area when the setting values are registered with a setting value write request (request 1).

The setting values are prescribed as follows:

4 stations shared

	Data type	Setting range
S0	Signed 32-bit binary	-999999~999999
S1	Signed 32-bit binary	-999999~999999
S2	Signed 32-bit binary	-999999~999999
Calibration number	Signed 16-bit binary	0~3

2 stations shared

	Data type	Setting range
S0	Signed 24-bit binary	0~999999
S1	Signed 32-bit binary	-999999~999999
Calibration number	Signed 8-bit binary	0~3

2) General data area (4 or 2 stations)

Setting values are set in this area when the setting values are registered with a general command request (request 2).

Commands set in this area specify the content of the general data area.

Data type: 32-bit binary

Setting range: Follows command no.

3) Command no. (4 or 2 stations)

Command numbers are set in this area when the command or data is registered with a general command request (request 2).

Commands set in this area specify the content of the general data area.

Data type: 8-bit binary

Setting range: 0~255

4) Operating mode (4 or 2 stations)

Mode numbers are set in this area when operating modes change with a mode-switching request (request 3).

Currently not supported by this equipment. Intended for future expansion.

Data type: 8-bit binary

Setting range: 0~255



(2) List of commands

Command numbers and the values set in the general data area when a command is issued with a general command request (request 2) are as follows:

Instructions on writing setting values and operation (selection of write/readout = writing [OFF])

Setting value or command issued	Command no. (RWwnE)	General data area (RWwnC~RWwnD)
Not used	1	
Not used	2	
Not used	3	
Not used	4	
Not used	5	
S0	6	
S1	7	
S2	8	
Not used	9	
Not used	10	
Not used	11	
Not used	12	
Not used	13	
Not used	14	
Not used	15	
Not used	16	
Not used	17	
Not used	18	
Not used	19	
Not used	20	
Setting of digital filter (moving average)	7001	
Analog filter	7002	
Display frequency	7004	
Digital filter at 40 times/s of AD sampling frequency	7005	
Digital filter at 400 times/s of AD sampling frequency	7006	
Digital filter at 4000 times/s of AD sampling frequency	7007	
Individual operation key lock 1	7008	
Individual operation key lock 2	7009	
Analog peak detecting circuit	7012	
Setting of CHECK value	7013	
Hold target	7018	
Comparator operation target	7021	
Comparator operating conditions	7022	
Comparator hysteresis operating conditions	7024	
Comparator hysteresis data width	7025	
Comparator hysteresis duration	7026	
Selection of operating mode for USB	7040	
Selection of output target when F-40 is set to 1 or 2	7041	
USB communication settings	7042	
Decimal point	7043	
Setting of number of digits of unit (combination of load display and status)	7044	
Setting of F key operation	7055	
Setting of INPUT1 operation	7060	

Setting value or command issued	Command no. (RWwnE)	General data area (RWwnC~RWwnD)
Setting of INPUT2	7061	
Setting of INPUT3	7062	
Setting of INPUT4	7063	
Setting of INPUT5	7064	
Setting of INPUT6	7065	
Setting of OUTPUT1 operation	7070	
Setting of OUTPUT2 operation	7071	
Setting of OUTPUT3 operation	7072	
Setting of OUTPUT4 operation	7073	
Setting of OUTPUT5 operation	7074	
Setting of OUTPUT6 operation	7075	
OUTPUT - Output logic	7082	
OUTPUT - Output logic	7083	
CC-Link - 32-bit data representation method	7087	
Calendar time adjustment (year)	7092	
Calendar time adjustment (month and date)	7093	
Calendar time adjustment (hour and minute)	7094	
Selection of number of digits in decimal place (calibration data 1)	7101	
AD sampling frequency	7102	
OL display conditions	7103	
Unit (unit output through for RS-232C)	7105	
Excitation voltage	7107	
Change in data storage location	7117	
Selection of calibration number	7118	
Selection of number of digits in decimal place (calibration data 2)	7142	
Selection of number of digits in decimal place (calibration data 3)	7143	
Selection of number of digits in decimal place (calibration data 4)	7144	
Detection mode	7301	
Designation of section	7302	
Change between single mode and multimode	7303	
Not used	7304	
Not used	7305	
Selection of detecting condition number	7309	
Setting of reference point (peak and bottom)	7310	
Detection data width (maximum and minimum)	7311	
Detection magnification (maximum and minimum)	7312	
Inflection point A - Detection data width (inflection point)	7320	
Inflection point A - Detection time A (inflection point)	7321	
Inflection point A - Detection time B (inflection point)	7322	

Setting value or command issued	Command no. (RWwnE)	General data area (RWwnC~RWwnD)
Inflection point A - Detection fine adjustment (inflection point)	7323	
Inflection point B - Detection data width (inflection point)	7324	
Inflection point B - Detection time A (inflection point)	7325	
Inflection point B - Detection time B (inflection point)	7326	
Inflection point B - Detection fine adjustment (inflection point)	7327	
Inflection point C - Detection data width (inflection point)	7328	
Inflection point C - Detection time A (inflection point)	7329	
Inflection point C - Detection time B (inflection point)	7330	
Inflection point C - Detection fine adjustment (inflection point)	7331	
Inflection point D - Detection data width (inflection point)	7332	
Inflection point D - Detection time A (inflection point)	7333	
Inflection point D - Detection time B (inflection point)	7334	
Inflection point D - Detection fine adjustment (inflection point)	7335	
Hold detection time (time-specified section, automatic start time-specified section)	7340	
Automatic start level (automatic start time-specified section)	7341	
Average update time (average)	7342	
Detection prohibit time	7343	
Waveform comparison and detection result judgment	7350	
Upper limit	7351	
Lower limit	7352	
Detection condition number for Area 1	7390	
Detection condition number for Area 2	7391	
Detection condition number for Area 3	7392	
Detection condition number for Area 4	7393	
Forced termination of calibration	9000	

Setting value or command issued	Command no. (RWwnE)	General data area (RWwnC~RWwnD)
Zero	0	1
Zero clear	0	2
PEAK	0	3
RESET	0	4
HOLD	0	5
Forced termination of multi	0	7

Reading out (selection of write/read out = reading out [OFF])

Setting value or command issued	Command no. (RWrnE)	General data area (RWrnC~RWrnD)
Not used	1	
Not used	2	
Not used	3	
Not used	4	
Not used	5	
S0	6	
S1	7	
S2	8	
Not used	9	
Not used	10	
Not used	11	
Not used	12	
Not used	13	
Not used	14	
Not used	15	
Not used	16	
Not used	17	
Not used	18	
Not used	19	
Not used	20	
Setting of digital filter (moving average)	7001	
Analog filter	7002	
Display frequency	7004	
Digital filter at 40 times/s of AD sampling frequency	7005	
Digital filter at 400 times/s of AD sampling frequency	7006	
Digital filter at 4000 times/s of AD sampling frequency	7007	
Individual operation key lock 1	7008	
Individual operation key lock 2	7009	
Analog peak detecting circuit	7012	
Setting of CHECK value	7013	
Hold target	7018	
Comparator operation target	7021	
Comparator operating conditions	7022	
Comparator hysteresis operating conditions	7024	
Comparator hysteresis data width	7025	
Comparator hysteresis duration	7026	
Selection of operating mode for USB	7040	
Selection of output target when F-40 is set to 1 or 2	7041	
USB communication settings	7042	
Decimal point	7043	
Setting of number of digits of unit (combination of load display and status)	7044	
Setting of F key operation	7055	
Setting of INPUT1 operation	7060	
Setting of INPUT2	7061	
Setting of INPUT3	7062	
Setting of INPUT4	7063	
Setting of INPUT5	7064	
Setting of INPUT6	7065	

Setting value or command issued	Command no. (RWrnE)	General data area (RWrnC~RWrnD)
Setting of OUTPUT1 operation	7070	
Setting of OUTPUT2 operation	7071	
Setting of OUTPUT3 operation	7072	
Setting of OUTPUT4 operation	7073	
Setting of OUTPUT5 operation	7074	
Setting of OUTPUT6 operation	7075	
OUTPUT - Output logic	7082	
OUTPUT - Output logic	7083	
CC-Link - Number of shared stations	7084	
CC-Link - Station number	7085	
CC-Link - Baud rate	7086	
CC-Link - 32-bit data representation method	7087	
Change method of calibration data and comparator brand code	7089	
Maintenance date input	7090	
Maintenance number input	7091	
Calendar time adjustment (year)	7092	
Calendar time adjustment (month and date)	7093	
Calendar time adjustment (hour and minute)	7094	
Selection of number of digits in decimal place (calibration data 1)	7101	
AD sampling frequency	7102	
OL display conditions	7103	
Unit (unit output through for RS-232C)	7105	
Excitation voltage	7107	
Change in data storage location	7117	
Selection of calibration number	7118	
Selection of number of digits in decimal place (calibration data 2)	7142	
Selection of number of digits in decimal place (calibration data 3)	7143	
Selection of number of digits in decimal place (calibration data 4)	7144	
Calibration data 1 - Unit weight	7150	
Calibration data 1 - Measuring weight	7151	
Calibration data 1 - Weight mass	7152	
Calibration data 1 - mV/V value of zero point	7153	
Calibration data 1 - mV/V value of span	7154	
Calibration data 2 - Unit weight	7155	
Calibration data 2 - Measuring weight	7156	
Calibration data 2 - Weight mass	7157	
Calibration data 2 - mV/V value of zero point	7158	
Calibration data 2 - mV/V value of span	7159	
Calibration data 3 - Unit weight	7160	
Calibration data 3 - Measuring weight	7161	
Calibration data 3 - Weight mass	7162	
Calibration data 3 - mV/V value of zero point	7163	
Calibration data 3 - mV/V value of span	7164	
Calibration data 4 - Unit weight	7165	

Setting value or command issued	Command no. (RWrnE)	General data area (RWrnC~RWrnD)
Calibration data 4 - Measuring weight	7166	
Calibration data 4 - Weight mass	7167	
Calibration data 4 - mV/V value of zero point	7168	
Calibration data 4 - mV/V value of span	7169	
Detection mode	7301	
Designation of section	7302	
Change between single mode and multimode	7303	
Not used	7304	
Not used	7305	
Selection of detecting condition number	7309	
Setting of reference point (peak and bottom)	7310	
Detection data width (maximum and minimum)	7311	
Detection magnification (maximum and minimum)	7312	
Inflection point A - Detection data width (inflection point)	7320	
Inflection point A - Detection time A (inflection point)	7321	
Inflection point A - Detection time B (inflection point)	7322	
Inflection point A - Detection fine adjustment (inflection point)	7323	
Inflection point B - Detection data width (inflection point)	7324	
Inflection point B - Detection time A (inflection point)	7325	
Inflection point B - Detection time B (inflection point)	7326	
Inflection point B - Detection fine adjustment (inflection point)	7327	
Inflection point C - Detection data width (inflection point)	7328	
Inflection point C - Detection time A (inflection point)	7329	
Inflection point C - Detection time B (inflection point)	7330	
Inflection point C - Detection fine adjustment (inflection point)	7331	
Inflection point D - Detection data width (inflection point)	7332	
Inflection point D - Detection time A (inflection point)	7333	
Inflection point D - Detection time B (inflection point)	7334	
Inflection point D - Detection fine adjustment (inflection point)	7335	
Hold detection time (time-specified section, automatic start time-specified section)	7340	

Setting value or command issued	Command no. (RWrnE)	General data area (RWrnC~RWrnD)
Automatic start level (automatic start time-specified section)	7341	
Average update time (average)	7342	
Detection prohibit time	7343	
Waveform comparison and detection result judgment	7350	
Upper limit	7351	
Lower limit	7352	
Detection condition number for Area 1	7390	
Detection condition number for Area 2	7391	
Detection condition number for Area 3	7392	
Detection condition number for Area 4	7393	
Calibration reading out confirmation (zero/span)	9040	

(3) Remote register

With 4 stations shared (this equipment → master station)			
Station	Remote register	Details	Notes
1	RWrn	1) Peak value	
	RWrn+1		
	RWrn+2	2) Track value	
	RWrn+3		
2	RWrn+4	Undefined	
	RWrn+5	Undefined	
	RWrn+6	3) Error code	
	RWrn+7	4) Auxiliary error code	
3	RWrn+8	9) Calibration number (lower 8 bit)	
	RWrn+9	Undefined	
	RWrn+A		
	RWrn+B		
4	RWrn+C	5) General data area	
	RWrn+D		
	RWrn+E	6) Command no. (response)	
	RWrn+F	7) Operating mode (response)	

n: Value determined by station number setting

With 2 stations shared (this equipment → master station)			
Station	Remote register	Details	Notes
1	RWrn	8) Indicated value (peak/track value)	
	RWrn+1		
	RWrn+2	3) Error code	
	RWrn+3	4) Auxiliary error code	
2	RWrn+4	5) General data area	
	RWrn+5		
	RWrn+6	6) Command no. (response)	
	RWrn+7	7) Operating mode (response)	

n: Value determined by station number setting

With 1 station shared (this equipment → master station)			
Station	Remote register	Details	Notes
1	RWrn	8) Indicated value (peak/track value)	
	RWrn+1		
	RWrn+2	3) Error code	
	RWrn+3	4) Auxiliary error code	

n: Value determined by station number setting



- 1) Peak value (4 stations)  
 Area indicating the peak value  
 Data type: Signed 32-bit binary  
 Data range: -999999~999999
  
- 2) Track value (4 stations)  
 Area indicating the track value  
 Data type: Signed 32-bit binary  
 Data range: -999999~999999
  
- 3) Error code (4, 2, or 1 station)  
 Area indicating errors on the indicator  
 For error details, see "(4) Auxiliary error code".  
 Data type: 16-bit binary  
 Data range: 0~255
  
- 4) Auxiliary error code (4, 2, or 1 station)  
 Area indicating error numbers on the indicator  
 Data type: 16-bit binary  
 Data range: 0~255

Error code	Auxiliary error code	Details
0	0	No error
2 Zero set error	1	Zero set error If zero set is executed under conditions when this is not possible
3 Other error	3	A/D conversion error
	31	EEPROM write error
	32	EEPROM readout error
	51	DAC abnormality
	99	Other than measurement mode
4 Calibration error	0	TE-L error
	1	TE-H error
	2	SP-L error
	3	SP-H error
99 Setting error	0	Undefined command received When irregular data is set in a command number
	1	Out-of-range error
	2	Unexecutable error



**Also refer to error display information in the device instruction manual for error details.**

5) General data area (4 or 2 stations)

Area indicating setting values when a general command request (request 2) is used to issue a command to read out setting values

Data type: Signed 32-bit binary

6) Command no. (response) (4 or 2 stations)

Area indicating command numbers when a command to read out setting values is issued with a general command request (request 2)

Data type: 8-bit binary

7) Operating mode (response) (4 or 2 stations)

Area indicating mode numbers when instructions on switching operating modes are issued with a mode-switching request (request 3) Currently not supported by this equipment. Intended for future expansion.

Data type: 8-bit binary

8) Indicated value (peak or track value) (2 or 1 station)

Area indicating peak or track values with the specified bit

Data type: Signed 32-bit binary

Data range: -999999~999999

9) Calibration number (4 stations)

Area indicating the calibration number

Data type: Signed 8-bit binary

Data range: 0~7

## Relay area

### 1) Remote output

With 4 stations shared (master station → this equipment)				
Device no.	Details			Classification
RYn0	1) Setting value write request (request 1)			Communication
RYn1				
RYn2	2) General command request (request 2)			
RYn3	3) Selection of readout/write (R/W)			
RYn4	4) Mode-switching request (request 3)			
RYn5				
RYn6				
RYn7				
RYn8				
RYn9				
RYnA				
RYnB				
RYnC				
RYnD				
RYnE				
RYnF				
RY(n+1)0	5) Zero			Basic signal
RY(n+1)1	6) Zero clear			
RY(n+1)2	7) PEAK			
RY(n+1)3	8) RESET			
RY(n+1)4	9) Hold			
RY(n+1)5	10) Forced termination of multi			
RY(n+1)6				
RY(n+1)7				
RY(n+1)8	11) CHECK ON			
RY(n+1)9	12) CHECK OFF			
RY(n+1)A				
RY(n+1)B				
RY(n+1)C				
RY(n+1)D				
RY(n+1)E				
RY(n+1)F				
RY(n+2)0	(13) Calibration number	10 <sup>0</sup>	1	
RY(n+2)1			2	
RY(n+2)2				
RY(n+2)3				
RY(n+2)4				
RY(n+2)5				
RY(n+6)6				
RY(n+6)7				
~				
RY(n+7)0	Reserved system area			
RY(n+7)1				
RY(n+7)2				
RY(n+7)3				
RY(n+7)4				
RY(n+7)5				
RY(n+7)6				
RY(n+7)7				
RY(n+7)8				
RY(n+7)9	14) Initial data setting request flag			
RY(n+7)A	15) Error reset request flag			
RY(n+7)B				
RY(n+7)C				
RY(n+7)D				
RY(n+7)E				
RY(n+7)F				

n: Value determined by station number setting

With 2 stations shared (master station → this equipment)			
Device no.	Details		Classification
RYn0	1) Setting value write request (request 1)		Communication
RYn1			
RYn2	2) General command request (request 2)		
RYn3	3) Selection of readout/write (R/W)		
RYn4	4) Mode-switching request (request 3)		
RYn5			
RYn6			
RYn7			
RYn8			
RYn9			
RYnA			
RYnB			
RYnC			
RYnD			
RYnE			
RYnF			
RY(n+1)0	5) Zero		
RY(n+1)1	6) Zero clear		
RY(n+1)2	7) PEAK		
RY(n+1)3	8) RESET		
RY(n+1)4	9) Hold		
RY(n+1)5	10) Forced termination of multi		
RY(n+1)6			
RY(n+1)7			
RY(n+1)8	11) CHECK ON		
RY(n+1)9	12) CHECK OFF		
RY(n+1)A			
RY(n+1)B			
RY(n+1)C			
RY(n+1)D			
RY(n+1)E			
RY(n+1)F	16) Peak/track indication value switching		
RY(n+2)0	13) Calibration number	10 <sup>0</sup>	1
RY(n+2)1			2
RY(n+2)2			
RY(n+2)3			
RY(n+2)4			
RY(n+2)5			
RY(n+2)6			
RY(n+2)7			
~			
RY(n+3)0	Reserved system area		
RY(n+3)1			
RY(n+3)2			
RY(n+3)3			
RY(n+3)4			
RY(n+3)5			
RY(n+3)6			
RY(n+3)7			
RY(n+3)8			
RY(n+3)9	14) Initial data setting request flag		
RY(n+3)A	15) Error reset request flag		
RY(n+3)B			
RY(n+3)C			
RY(n+3)D			
RY(n+3)E			
RY(n+3)F			

n: Value determined by station number setting

With 1 station shared (master station → this equipment)					
Device no.	Details			Classification	
RYn0	5) Zero			Basic signal	
RYn1	6) Zero clear				
RYn2	7) PEAK				
RYn3	8) RESET				
RYn4	9) Hold				
RYn5	11) CHECK ON				
RYn6	12) CHECK OFF				
RYn7	16) Peak/track indication value switching				
RYn8	13) Calibration number	10 <sup>0</sup>	1		
RYn9			2		
RYnA					
RYnB					
RYnC					
RYnD					
RYnE					
RYnF					
RY(n+1)0	Reserved system area				
RY(n+1)1					
RY(n+1)2					
RY(n+1)3					
RY(n+1)4					
RY(n+1)5					
RY(n+1)6					
RY(n+1)7					
RY(n+1)8					
RY(n+1)9	14) Initial data setting request flag				
RY(n+1)A	15) Error reset request flag				
RY(n+1)B					
RY(n+1)C					
RY(n+1)D					
RY(n+1)E					
RY(n+1)F					

n: Value determined by station number setting

\* Errors are reset from the device, because there is no error reset request flag when one station is shared. (Issued with device reset.)

1) Setting value write request (request 1)

Requests writing of data set in the dedicated data area (RWwn0~RWwnB).

- ON: Write request
- OFF: After confirming setting value write response (response 1)

2) General command request (request 2)

Requests reading out/writing, by issuing a command.

Use in conjunction with selection of readout/write (R/W).

- ON: Readout/write request
- OFF: After confirming general command response (response 2)

3) Selection of readout/write (R/W)

Selects reading out/writing, by issuing a command.

For writing, indicates writing of data set in the general data area (RWwnC~RWwnD) by using a command no. (RWwnE).

For reading out, indicates reading out of data set in the general data area (RWrnC~RWrnD) by using a command no. (RWwnE).

- ON: Readout
- OFF: Write

4) Mode-switching request (request 3)

Requests writing of values set in the operating mode (RWwnF).

Currently not supported by this equipment. Intended for future expansion.

- ON: Switching request
- OFF: After confirming mode switching response (response 3)

5) Zero

Sets zero.

- ON: Zero setting request (OFF → ON represents one operation)
- OFF: Normal

6) Zero clear

Clears to zero.

- ON: Zero setting request (OFF → ON represents one operation)
- OFF: Normal

7) PEAK

Selects the track or various peak detections.

- ON: PEAK request (OFF → ON represents one operation)
- OFF: Normal

8) RESET

Resets the peak.

- ON: RESET request (OFF → ON represents one operation)
- OFF: Normal

- 9) Hold  
 Holds.  
 ON: Hold (level operation)  
 OFF: Hold off
- 10) Forced termination of multi  
 Forces termination of multihold operation.  
 ON: Forced termination of multi request (OFF → ON represents one operation)  
 OFF: Normal
- 11) CHECK ON  
 Displays the check value.  
 ON: CHECK ON request (OFF → ON represents one operation)  
 OFF: Normal
- 12) CHECK OFF  
 Clears check value display.  
 ON: CHECK OFF signal on (OFF → ON represents one operation)  
 OFF: Normal
- 13) Calibration number  
 Sets the calibration number, using BCD code.  
 When using CC-Link to change brand code numbers, set function F-89 to 2.  
 Changing the brand code number during a sequence will cause error code 99 and auxiliary error code 2.
- 14) Initial data setting request flag  
 Currently not supported by this equipment. Does not initialize data.  
 ON: Initialization request  
 OFF: Normal
- 15) Error reset request flag  
 Requests the clearing of errors in the case of error notification from error status flag RX(n+7)A. The error type and number are cleared to 0.  
 ON: Resetting request (OFF → ON represents one operation)  
 OFF: Normal
- 16) Peak/track indication value switching  
 When 1 or 2 stations are shared, switches the load set in the specified area of the remote register as follows:  
 ON: Track (same as track value in remote register when 4 stations are shared)  
 OFF: Peak (same as peak value in remote register when 4 stations are shared)

1) Remote input

With 4 stations shared (this equipment → master station)				
Device no.	Details		Classification	
RXn0	1) Setting value write response (response 1)		Communication	
RXn1				
RXn2	2) General command response (response 2)			
RXn3	3) Readout/write selection response (R/W response)			
RXn4	4) Mode-switching response (response 3)			
RXn5				
RXn6	5) Normal CPU operation			
RXn7				
RXn8	6) Decimal point display position 1			
RXn9	6) Decimal point display position 2			
RXnA	6) Decimal point display position 4			
RXnB			Basic signal	
RXnC				
RXnD				
RXnE				
RXnF				
RX(n+1)0	7) PEAK			
RX(n+1)1	7) MEAS			
RX(n+1)2	7) END			
RX(n+1)3	7) CHECK			
RX(n+1)4	7) HOLD			
RX(n+1)5	7) MULTI (multimode is used)			
RX(n+1)6	7) EXECUTE (measurement in the multimode)			
RX(n+1)7	7) OK			
RX(n+1)8	7) NG			
RX(n+1)9	7) Upper/lower limit			
RX(n+1)A	7) S0			
RX(n+1)B	7) S1			
RX(n+1)C	7) S2			
RX(n+1)D				
RX(n+1)E	8) Weighing capacity over			
RX(n+1)F	9) Faulty weight			
RX(n+2)0	10) Calibration number	10 <sup>0</sup>	1	
RX(n+2)1			2	
RX(n+2)2				
RX(n+2)3				
RX(n+2)4				
RX(n+2)5				
RX(n+2)6				
RX(n+2)7				
~				
RX(n+7)0	Reserved system area			
RX(n+7)1				
RX(n+7)2				
RX(n+7)3				
RX(n+7)4				
RX(n+7)5				
RX(n+7)6				
RX(n+7)7				
RX(n+7)8				
RX(n+7)9	11) Initial data setting complete flag			
RX(n+7)A	14) Error status flag			
RX(n+7)B	15) Remote ready			
RX(n+7)C				
RX(n+7)D				
RX(n+7)E				
RX(n+7)F				

n: Value determined by station number setting

\* Faulty weight is set to ON due to errors other than measurement sequence errors.



With 2 stations shared (this equipment → master station)				
Device no.	Details			Classification
RXn0	1) Setting value write response (response 1)			Communication
RXn1				
RXn2	2) General command response (response 2)			
RXn3	3) Readout/write selection response (R/W response)			
RXn4	4) Mode-switching response (response 3)			
RXn5				
RXn6	5) Normal CPU operation			
RXn7				
RXn8	6) Decimal point display position 1			
RXn9	6) Decimal point display position 2			
RXnA	6) Decimal point display position 4			
RXnB				
RXnC				
RXnD				
RXnE				
RXnF				
RX(n+1)0	7) PEAK			Basic signal
RX(n+1)1	7) MEAS			
RX(n+1)2	7) END			
RX(n+1)3	7) CHECK			
RX(n+1)4	7) HOLD			
RX(n+1)5	7) MULTI (multimode is used)			
RX(n+1)6	7) EXECUTE (measurement in the multimode)			
RX(n+1)7	7) OK			
RX(n+1)8	7) NG			
RX(n+1)9	7) Upper/lower limit			
RX(n+1)A	7) S0			
RX(n+1)B	7) S1			
RX(n+1)C	7) S2			
RX(n+1)D				
RX(n+1)E	8) Weighing capacity over			
RX(n+1)F	9) Faulty weight			
RX(n+2)0	10) Calibration number	10 <sup>0</sup>	1	
RX(n+2)1			2	
RX(n+2)2				
RX(n+2)3				
RX(n+2)4				
RX(n+2)5				
RX(n+2)6				
RX(n+2)7				
~				
RX(n+3)0	Reserved system area			
RX(n+3)1				
RX(n+3)2				
RX(n+3)3				
RX(n+3)4				
RX(n+3)5				
RX(n+3)6				
RX(n+3)7				
RX(n+3)8				
RX(n+3)9	11) Initial data setting complete flag			
RX(n+3)A	12) Error status flag			
RX(n+3)B	13) Remote ready			
RX(n+3)C				
RX(n+3)D				
RX(n+3)E				
RX(n+3)F				

n: Value determined by station number setting

\* Faulty weight is set to ON due to errors other than measurement sequence errors.

With 1 station shared (this equipment → master station)		
Device no.	Details	Classification
RXn0	7) PEAK	Basic signal
RXn1	7) MEAS	
RXn2	7) END	
RXn3	7) CHECK	
RXn4	7) HOLD	
RXn5	7) MULTI (multimode is used)	
RXn6	7) EXECUTE (measurement in the multimode)	
RXn7	7) OK	
RXn8	7) NG	
RXn9	7) Upper/lower limit	
RXnA	7) S0	
RXnB	7) S1	
RXnC	7) S2	
RXnD		
RXnE	8) Weighing capacity over	
RXnF	9) Faulty weight	
RX(n+1)0	Reserved system area	
RX(n+1)1		
RX(n+1)2		
RX(n+1)3		
RX(n+1)4		
RX(n+1)5		
RX(n+1)6		
RX(n+1)7		
RX(n+1)8		
RX(n+1)9	11) Initial data setting complete flag	
RX(n+1)A	12) Error status flag	
RX(n+1)B	13) Remote ready	
RX(n+1)C		
RX(n+1)D		
RX(n+1)E		
RX(n+1)F		

n: Value determined by station number setting

\* Faulty weight is set to ON due to errors other than measurement sequence errors.

- 1) Setting value write response (response 1)  
 Notifies of completion of writing after a setting value write request (request 1).  
 ON: Writing complete  
 OFF: After confirming the setting value write request (request 1) is off
  
- 2) General command response (response 2)  
 Notifies the completion of command issuance after a general command request (request 2).  
 ON: Command issuance complete  
 OFF: After confirming the general command request (request 2) is off
  
- 3) Readout/write selection response (R/W response)  
 Notifies the status of command-initiated reading out/writing, when notified from a general command response (response 2).  
 ON: Readout  
 OFF: Write
  
- 4) Mode-switching response (response 3)  
 Notifies the completion of mode switching after a mode-switching request (request 3).  
 Currently not supported by this equipment. Intended for future expansion.  
 ON: Switching complete  
 OFF: After confirming mode-switching request (request 3) is off
  
- 5) Normal CPU operation  
 Notifies the normal operation of CC-Link cards.  
 ON → OFF → ON is executed in 0.5 sec. intervals.



**Momentary delays in the signal indicating normal CPU operation occur when various setting values are being stored or the memory is being cleared.**

- 6) Decimal point display positions 1, 2, and 4  
 Notifies the decimal point display position in the display, using three binary values.

Decimal point display position	Decimal point display position 1	Decimal point display position 2	Decimal point display position 4
None	Off	Off	Off
1	On	Off	Off
2	Off	On	Off
3	On	On	Off
4	Off	Off	On

- 7) PEAK and other statuses  
 Notifies the status of PEAK, MEAS, END, CHECK, HOLD, MULTI, EXECUTE, OK, NG, Upper/lower limit, S0, S1, and S2.
  
- 8) Weighing capacity over  
 Notifies abnormalities (OL, OVF, -OL, and -OVF) when overloading occurs.  
 ON: Abnormality  
 OFF: Normal

9) Faulty weight

Notifies excessive measuring weight or zero set error.

ON: Abnormality

OFF: Normal

10) Calibration number

Constant output of the calibration number, using BCD code

11) Initial data setting complete flag

Currently not supported by this equipment. Data is not initialized, even when the flag is on.

ON: Setting complete

OFF: Normal

12) Error status flag

Notifies errors on the indicator.

ON: Error

OFF: Normal

13) Remote ready

Notifies that initialization is complete and communication is possible.

ON: Ready for communication

OFF: Initialization in progress

## 6. Calibration

Calibration using CC-Link Interface is possible with a general command request (request 2) when 4 or 2 stations are shared. To perform this calibration, complete the settings according to the following flowchart:

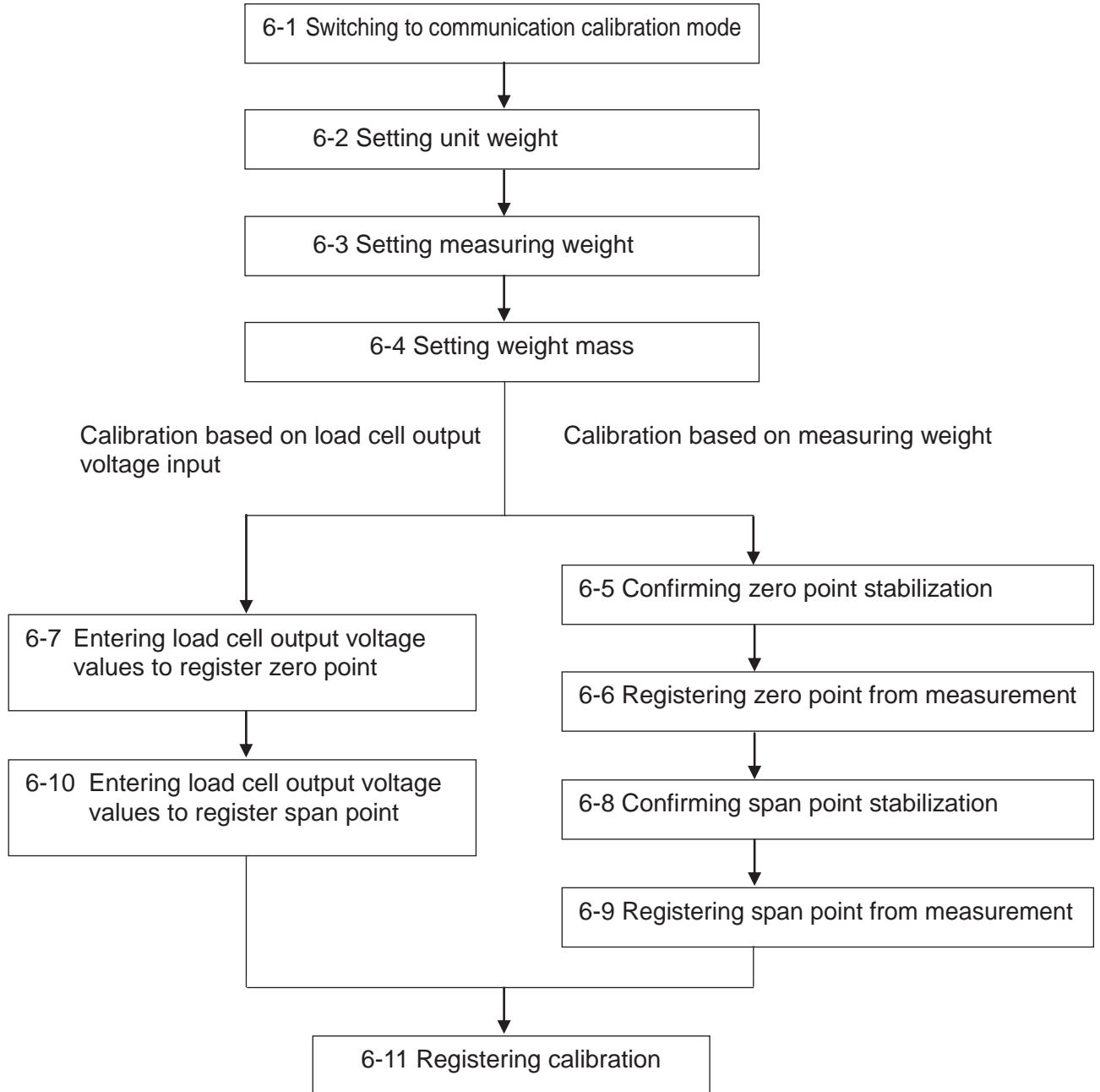

- During communication calibration mode, [-RS-] is displayed on the indicator.
- For details on error codes in communication calibration mode, see Section 5-2-1 (3) "Remote register (this equipment → master) (4) Auxiliary error code (4, 2, or 1 station)".
- If calibration is terminated, no calibration data is registered, and the original state before calibration is restored.
- For calibration based on registering measuring weight, always confirm stabilization using the stabilization confirmation function before registering values.

## 6-1. Switching to communication calibration mode

Write the data in the following table to switch to calibration mode.

Writing data other than [0] to the general data area causes an out-of-range error.

(Error code: 99, auxiliary error code: 1)

Command no. (RWwnE): 4 stations shared (RWwn6): 2 stations shared	General data area (RWwnC~RWwnD): 4 stations shared (RWwn4~RWwn5): 2 stations shared
9001	0

### Unexecutable error

The following codes are set if attempted in modes other than measurement display mode or if calibration lock is on:

Status	Error code	Auxiliary error code
Unexecutable error	99	2

## 6-2. Setting unit weight

Write the data in the following table to set unit weight:

Command no. (RWwnE): 4 stations shared (RWwn6): 2 stations shared	General data area (RWwnC~RWwnD): 4 stations shared (RWwn4~RWwn5): 2 stations shared	
9002	Unit weight	Setting
	1	1
	2	2
	5	5
	10	10
	20	20
	50	50

### Out-of-range error

The following codes are set if the out-of-range data is written:

Status	Error code	Auxiliary error code
Out-of-range error	99	1

### Unexecutable error

The following codes are set if performed in modes other than calibration mode or if not set according to the flowchart at the beginning of this chapter:

Status	Error code	Auxiliary error code
Unexecutable error	99	2

### 6-3. Setting measuring weight

Write the data in the following table to set measuring weight:

Command no. (RWwnE): 4 stations shared (RWwn6): 2 stations shared	General data area (RWwnC~RWwnD): 4 stations shared (RWwn4~RWwn5): 2 stations shared
9003	Data range: 1~999999

#### Out-of-range error

The following codes are set if the out-of-range data is written:

Status	Error code	Auxiliary error code
Out-of-range error	99	1

#### Unexecutable error

The following codes are set if performed in modes other than calibration mode or if not set according to the flowchart at the beginning of this chapter:

Status	Error code	Auxiliary error code
Unexecutable error	99	2

### 6-4. Setting weight mass

Write the data in the following table to set weight mass:

Command no. (RWwnE): 4 stations shared (RWwn6): 2 stations shared	General data area (RWwnC~RWwnD): 4 stations shared (RWwn4~RWwn5): 2 stations shared
9004	Data range: 1~999999 However, not exceeding the measuring weight

#### Out-of-range error

The following codes are set if the out-of-range data is written:

Status	Error code	Auxiliary error code
Out-of-range error	99	1

#### Unexecutable error

The following codes are set if performed in modes other than calibration mode or if not set according to the flowchart at the beginning of this chapter:

Status	Error code	Auxiliary error code
Unexecutable error	99	2

## 6-5. Confirming zero point stabilization

Set the data in the following table to read out the stable or unstable status:

Command no. (RWwnE): 4 stations shared (RWwn6): 2 stations shared	General data area (RWwnC~RWwnD): 4 stations shared (RWwn4~RWwn5): 2 stations shared
9006	Optional

The stable or unstable status read out is set as shown in the following table:

Command no. (RWrnE): 4 stations shared (RWrn6): 2 stations shared	General data area (RWrnC~RWrnD): 4 stations shared (RWrn4~RWrn5): 2 stations shared
9006	0: Unstable 1: Stable

### Unexecutable error

The following codes are set if performed in modes other than calibration mode:

Status	Error code	Auxiliary error code
Unexecutable error	99	2

## 6-6. Registering zero point from measurement

Write the data in the following table to register the load cell output value as the zero point.

Writing data other than [0] to the general data area causes an out-of-range error.

(Error code: 99, auxiliary error code: 1)

Command no. (RWwnE): 4 stations shared (RWwn6): 2 stations shared	General data area (RWrnC~RWrnD): 4 stations shared (RWrn4~RWrn5): 2 stations shared
9007	0

### TE-L error

The following codes are set if the load cell output value read out (in mV/V) is less than -2.5 mV/V and exceeds the zero adjustment range on the negative side:

Status	Error code	Auxiliary error code
TE-L error	4	0

### TE-H error

The following codes are set if the load cell output value that is read (in mV/V) exceeds 2.5 mV/V and the zero adjustment range on the positive side:

Status	Error code	Auxiliary error code
TE-H error	4	1

### Unexecutable error

The following codes are set if performed in modes other than calibration mode or if not set according to the flowchart at the beginning of this chapter:

Status	Error code	Auxiliary error code
Unexecutable error	99	2



## 6-7. Entering load cell output voltage values to register zero point

Write the data in the following table to enter a numerical value for registering the zero point. Values can be registered in 0.00001mV/v increments.

Command no. (RWwnE): 4 stations shared (RWwn6): 2 stations shared	General data area (RWwnC~RWwnD): 4 stations shared (RWwn4~RWwn5): 2 stations shared
9008	Data range: -250000~250000 (-2.5 mV/V~2.5 mV/V)

### TE-L error

The following codes are set if the load cell output value set (in mV/V) is less than -2.5 mV/V and exceeds the zero adjustment range on the negative side:

Status	Error code	Auxiliary error code
TE-L error	4	0

### TE-H error

The following codes are set if the load cell output value set (in mV/V) exceeds 2.5 mV/V and the zero adjustment range on the positive side:

Status	Error code	Auxiliary error code
TE-H error	4	1

### Unexecutable error

The following codes are set if performed in modes other than calibration mode or if not set according to the flowchart at the beginning of this chapter:

Status	Error code	Auxiliary error code
Unexecutable error	99	2

## 6-8. Confirming span point stabilization

\* Perform the same as confirming zero point stabilization.

Set the data in the following table to read out the stable or unstable status:

Command no. (RWwnE): 4 stations shared (RWwn6): 2 stations shared	General data area (RWwnC~RWwnD): 4 stations shared (RWwn4~RWwn5): 2 stations shared
9006	Optional

The stable or unstable status read out is set as shown in the following table:

Command no. (RWrnE): 4 stations shared (RWrn6): 2 stations shared	General data area (RWrnC~RWrnD): 4 stations shared (RWrn4~RWrn5): 2 stations shared
9006	0: Unstable 1: Stable

## 6-9. Registering span point from measurement

Write the data in the following table to register the load cell output value as the span point.

Writing data other than [0] to the general data area causes an out-of-range error.

(Error code: 99, auxiliary error code: 1)

Command no. (RWwnE): 4 stations shared (RWwn6): 2 stations shared	General data area (RWwnC~RWwnD): 4 stations shared (RWwn4~RWwn5): 2 stations shared
9010	0

### SP-L error

The following codes are set if the load cell output value read is less than 0 mV/V and not within the span adjustment range (span point load cell output voltage - zero point load cell output voltage  $\leq$  0.0 mV/V):

Status	Error code	Auxiliary error code
SP-L error	4	2

### SP-H error

The following codes are set if the load cell output value read exceeds 3.1 mV/V and the span adjustment range:

Status	Error code	Auxiliary error code
SP-H error	4	3

### Unexecutable error

The following codes are set if performed in modes other than calibration mode or if not set according to the flowchart at the beginning of this chapter:

Status	Error code	Auxiliary error code
Unexecutable error	99	2

## 6-10. Entering load cell output voltage values to register span point

Write the data in the following table to enter a numerical value for registering the span point. Values can be registered in 0.00001mV/v increments.

Command no. (RWwnE): 4 stations shared (RWwn6): 2 stations shared	General data area (RWwnC~RWwnD): 4 stations shared (RWwn4~RWwn5): 2 stations shared
9011	Data range: 1~310000 (0.00001 mV/V~3.1 mV/V)

### SP-L error

The following codes are set if the load cell output value set is less than 0 mV/V and not within the span adjustment range (span point load cell output value - zero point load cell output value  $\leq$  0.0 mV/V):

Status	Error code	Auxiliary error code
SP-L error	4	2

### SP-H error

The following codes are set if the load cell output value set exceeds 3.1 mV/V and the span adjustment range:

Status	Error code	Auxiliary error code
SP-H error	4	3

### Unexecutable error

The following codes are set if performed in modes other than calibration mode or if not set according to the flowchart at the beginning of this chapter:

Status	Error code	Auxiliary error code
Unexecutable error	99	2

## 6-11. Ending calibration

Write the data in the following table to store your provisionally registered calibration data, such as zero and span point data, and return to measurement mode.

Writing data other than [0] to the general data area causes an out-of-range error.

(Error code: 99, auxiliary error code: 1)

Command no. (RWwnE): 4 stations shared (RWwn6): 2 stations shared	General data area (RWwnC~RWwnD): 4 stations shared (RWwn4~RWwn5): 2 stations shared
9099	0

### Unexecutable error

The following codes are set if performed in modes other than calibration mode or if not set according to the flowchart at the beginning of this chapter:

Status	Error code	Auxiliary error code
Unexecutable error	99	2



- All LEDs on the indicator are illuminated when calibration mode is exited before entering measurement mode.
- Because this fully illuminated state is not measurement mode, error code 3 and auxiliary error code 99 occur.

## 6-12. Forced termination of calibration

Write the data in the following table during the calibration procedure to stop calibration and return to measurement mode without storing your provisionally registered calibration data.

Writing data other than [0] to the general data area causes an out-of-range error.

(Error code: 99, auxiliary error code: 1)

Command no. (RWwnE): 4 stations shared (RWwn6): 2 stations shared	General data area (RWwnC~RWwnD): 4 stations shared (RWwn4~RWwn5): 2 stations shared
9000	0

### Unexecutable error

The following codes are set if performed in modes other than calibration mode or if not set according to the flowchart at the beginning of this chapter:

Status	Error code	Auxiliary error code
Unexecutable error	99	2



- All LEDs on the indicator are illuminated when calibration mode is exited before entering measurement mode.
- Because this fully illuminated state is not measurement mode, error code 3 and auxiliary error code 99 occur.

## 7. Operating Instructions

### 7-1. Writing setting values

Setting values are written using setting value write requests from the master station.

When a setting value write request (request 1) [RYn0] sent from the master station is ON, data set in the dedicated data area [RWwn0 to RWwn+9] is written to the indicator.

After writing is complete, a response is issued to the master station using setting value write response (response 1) [RXn0].

Time chart

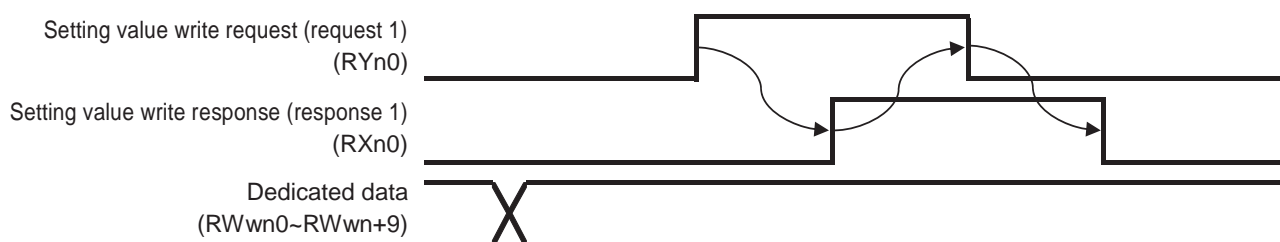

### 7-2. Reading out/writing using general commands

Operations are performed in accordance with commands issued using general command requests from the master station.

When a general command request (request 2) [RYn2] sent from the master station is ON, data set in general data area [RWrn+C to D] is written or data is read out to general data area [RWwn+C to D] using selection of read/write [RYn3] and command no. [RWwn+E].

After reading out/writing is complete, a response is issued to the master station using general command response (response 2) [RXn2].

(1) Write request

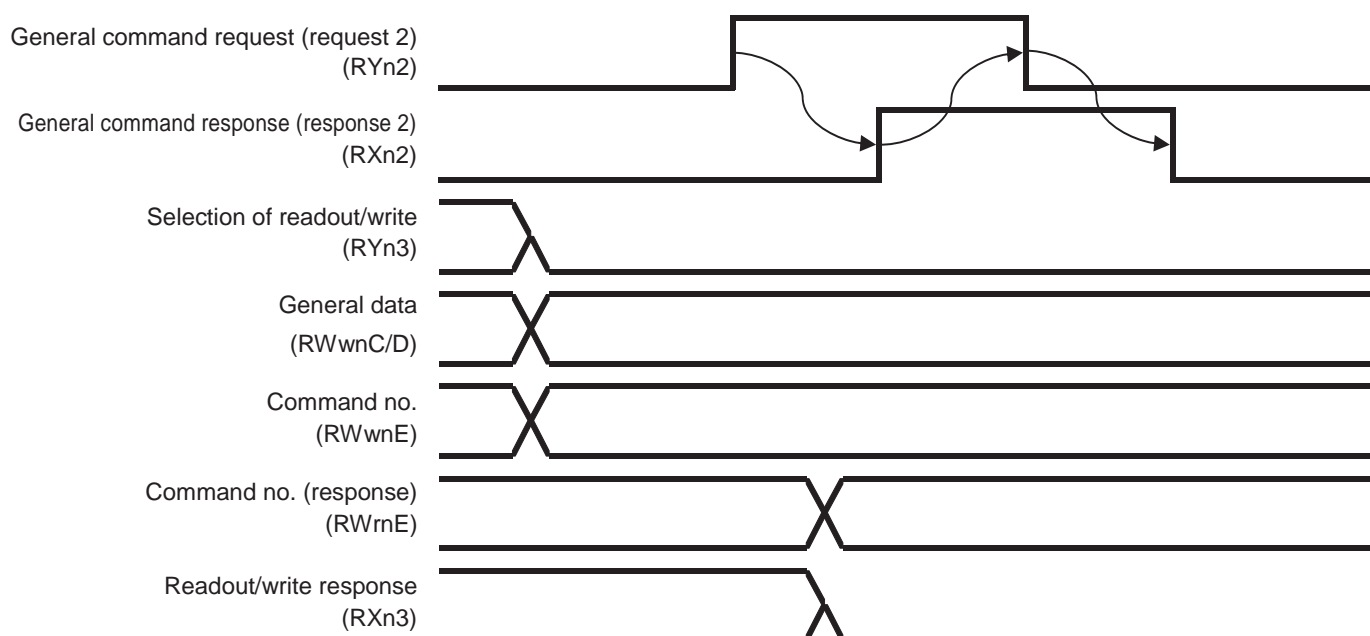

**Specify internal RAM as the storage destination if you change setting values constantly and EEPROM rewriting may exceed 1 million cycles.**

(2) Readout request

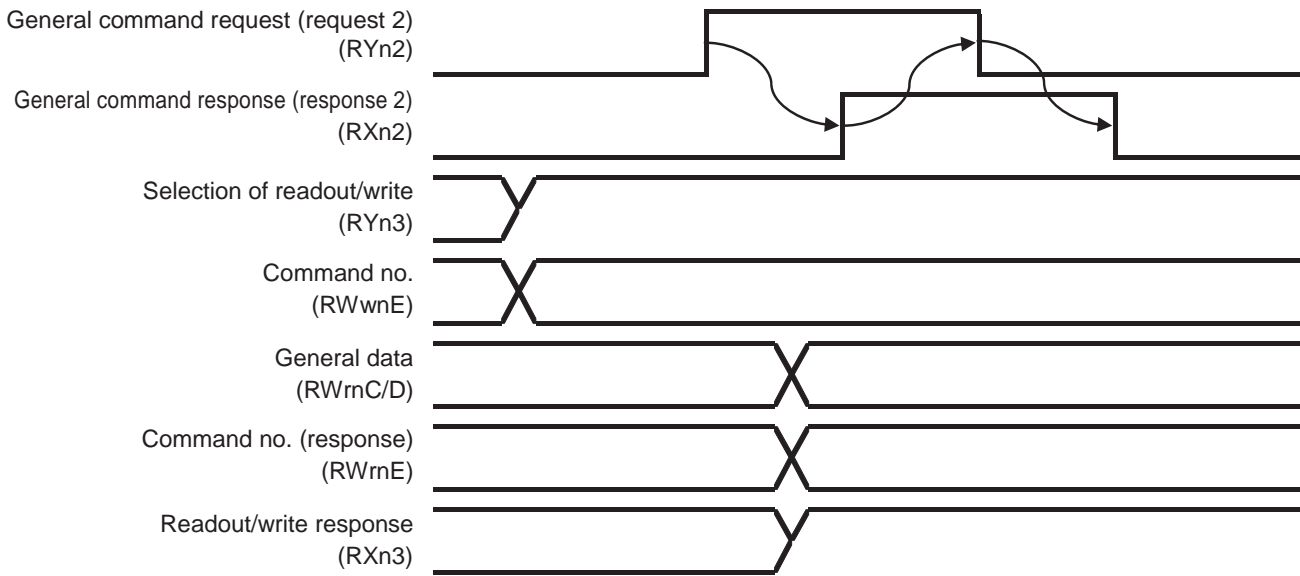

### 7-3. Preparing for communication

After power-on and the initial data setting request from the master station, an indication is given that communication is possible.

After power-on and completion of initialization (initial settings), remote ready [RX(n+7)B] is set to ON to make communication possible.

When initial data setting request [RY(n+7)9] sent from the master station is ON, remote ready [RX(n+7)B] is set to OFF and initialization is performed.

After completion of initialization, initial settings complete [RX(n+7)9] is set to ON and a response is issued to the master station.

If the master station recognizes that initial settings complete [RX(n+7)9] is ON, initial data setting request [RY(n+7)9] is set to OFF to set initial settings complete [RX(n+7)9] to OFF and remote ready [RX(n+7)B] is set to ON.

#### Timing chart

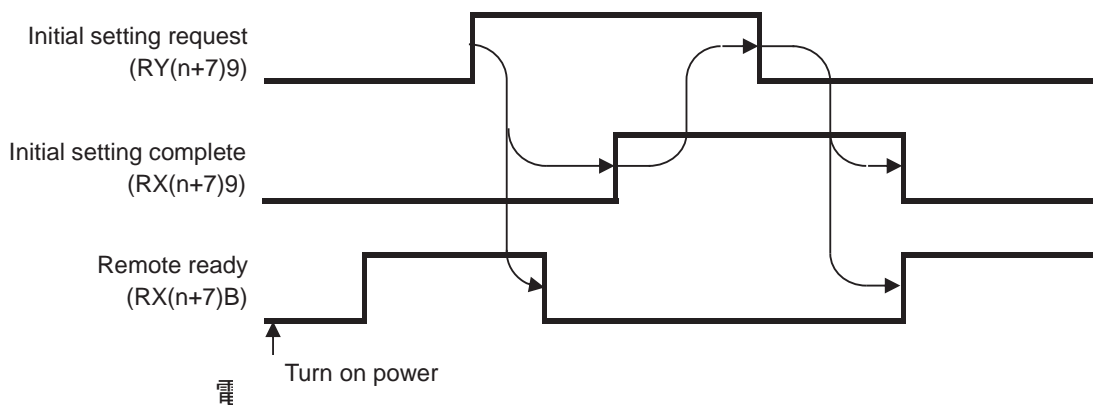

#### 7-4. Error status and reset request flag

Status and reset sequences in the case of errors of this equipment are as follows:

If errors occur, after remote ready [RX(n+7)B] is set to OFF, error status flag [RX(n+7)A] is switched to ON.

When error reset request flag [RY(n+7)A] ON is sent from the master station, error status flag [RX(n+7)A] is switched to OFF.

After this, if error reset request flag [RY(n+7)A] OFF is sent from the master station, remote ready [RX(n+7)B] is switched to ON. Clear any errors of this equipment using the following sequence:

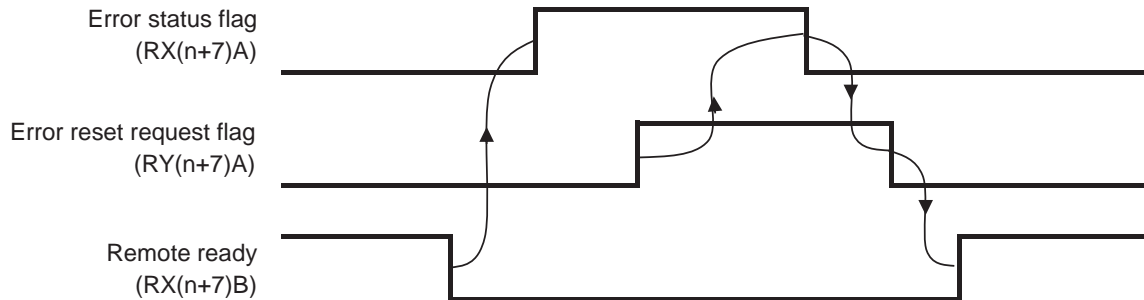

#### 7-5. Normal CPU operation signal

Master station is notified that this equipment is operating normally.

When this equipment is operating normally, normal CPU operation signal [RXn6] is inverted every 500 ms.

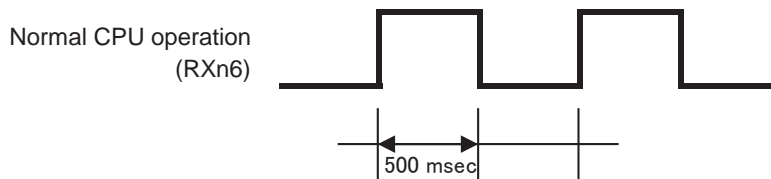

**Momentary delays in the signal indicating normal CPU operation occur when various setting values are being stored or the memory is being cleared.**

## 8. Interface Specifications

### 8-1. CC-Link Interface specifications

Specification	Details
Version	Ver. 1.10
Number of shared stations	1, 2, or 4
Communication system	Polling
Synchronous mode	Bit synchronous
Baud rate	156 kbps, 625 kbps, 2.5 Mbps, 5 Mbps, or 10 Mbps
Transmission path	RS-485 bus
Transmission format	Conforming to HDLC
Remote station number	1 station shared: 01~64 2 stations shared: 01~63 4 stations shared: 01~61
Number of connections	1 station shared: Max. 64 2 station shared: Max. 32 4 station shared: Max. 16
Termination	External resistor
Status LEDs	[RUN], [ERR], [SD], and [RD]

### 8-2. Accessories

CC-Link Communication Connector	x1 (MSTB 2,5/5-ST-5,08 AU, manufactured by Phoenix Contact)
---------------------------------	---