

■NOTICE DURING INSTALLATION



Warning

Warning that causes injury or accident and develops into harm to the operator.
Do not do these things described here.

In the case of carriage

- When you carry the instrument, check that there is no looseness at the fixed bolt on the guide plate. There may be fears of disassembly of the instrument or falling down of the accessories.
- It's strictly prohibited from lifting up the load cell cable, when you carry the instrument. There may be fears of cutting off the cable or falling down of the instrument.

Location to install

- When you install the instrument, be sure to work with full considerations on safety.
- Use the instrument where the temperature/humidity specifies within the range as follows:
 - Environmental temperature: -10°C to 70°C
 - Environmental humidity: Less than 85%RH
- When you install, tighten the bolts securely with consideration on deflection stay. If you neglect, there may be fears of deterioration in the specifications for the instrument.
- Don't weld the plate section of the instrument on the structures (beam, bracket and so on) together directly. There may be the fear of deterioration in the specifications for the instrument.
- Protect the load cell cable with the piping materials. Due to the external injury, chemicals and washing, there may be deterioration in insulation or cutting off the cable by the deterioration of cover.
- The clearance hole should be prepared for the bracket at the turnover preventing device of the instrument.
- Be sure to keep the instruction manual for the instrument, and also all of the removed parts at hand. They will become necessary when maintenance is required.

■Record of revision

Date	Instruction No.	Contents
Sep,2019	DRW.EN293-1007	First version

■Each name

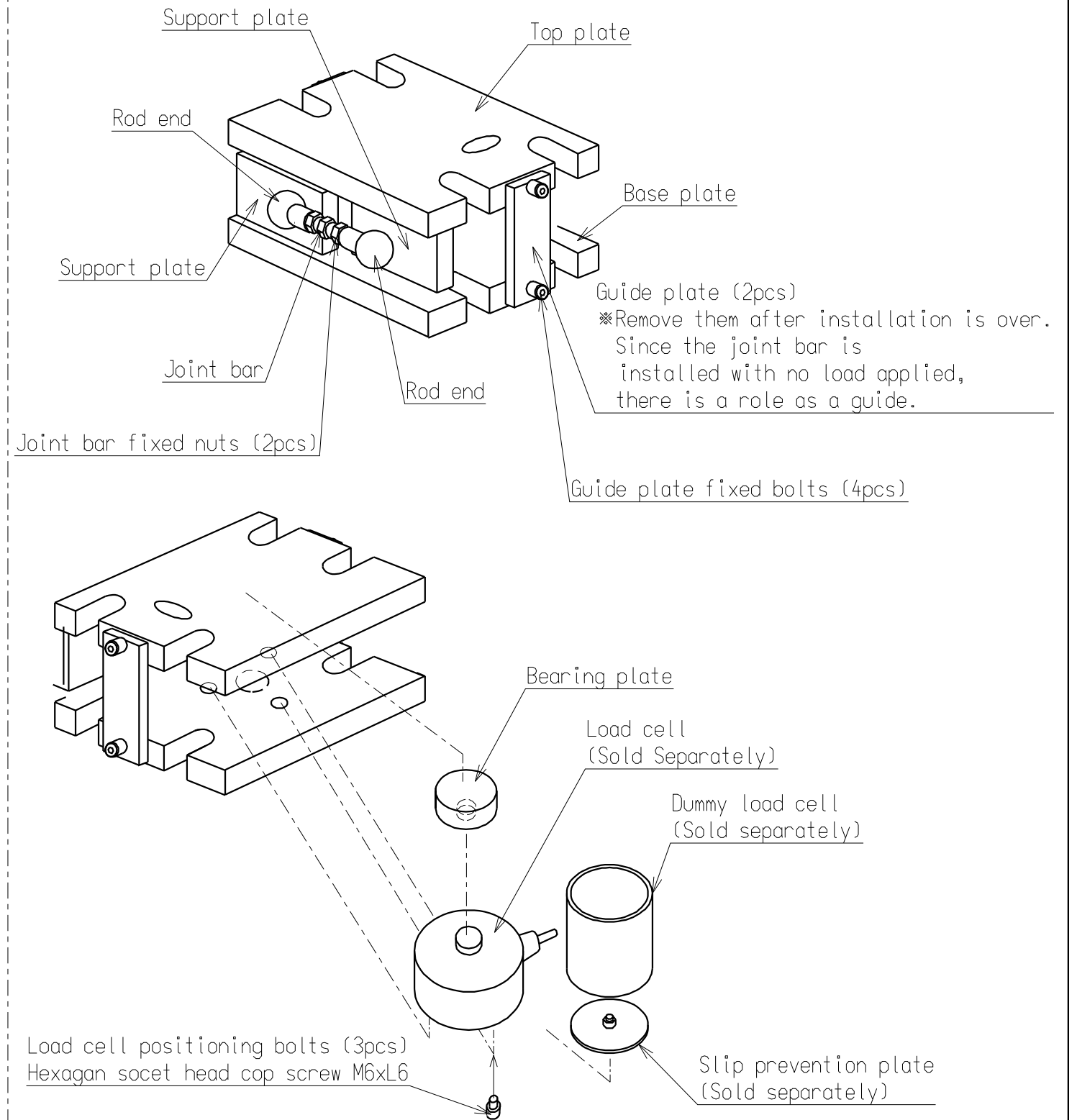

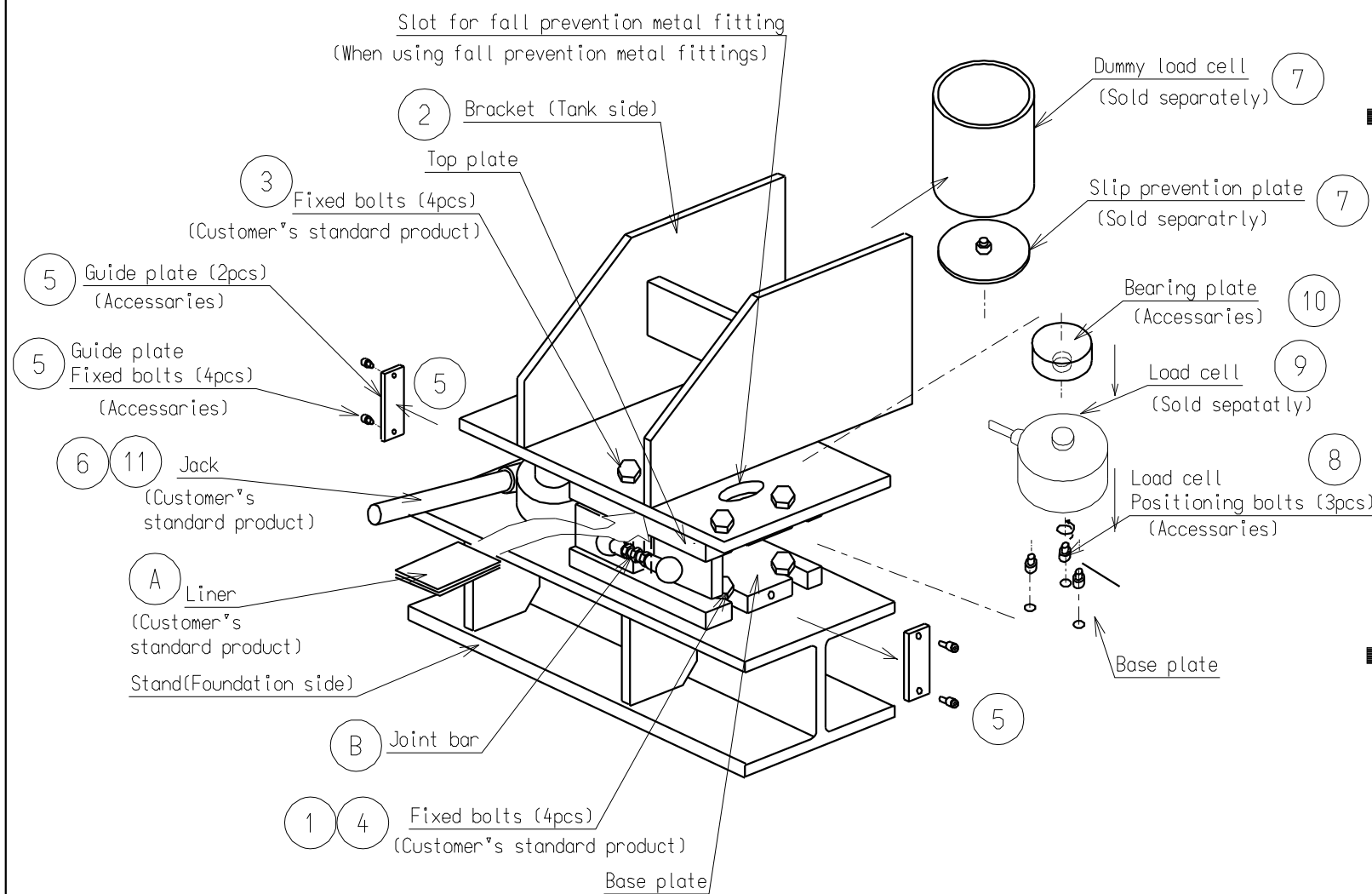

■ Example of installation procedures

- ① Fix the base plate on the stand preliminarily.
※The level on the upper surface of the stand should be within ± 0.3 deg.
- ② Lower the tank.
- ③ Fix the top plate to the bracket.
- ④ Fix the base plate to the stand.
- ⑤ Remove the guide plate.
(When the dummy load cell is purchased, the following work is done succeeding.)
- ⑥ Lift up the tank approx.3 mm with a jack.
- ⑦ Remove the dummy load cell and slip prevention plate.
- ⑧ The load cell pin is attached to the bottom of a load cell.
- ⑨ Place the load cell on the base plate.
- ⑩ Put the bearing plate on the load cell.
- ⑪ Lower the tank slowly.

■ Example of adjustment procedures

After installing the instrument, make adjustment on the installation as follows:
Ideal Condition

- At the time of tare weight load application, controls the output of each load cell less than 30% (standard) of deviation against the equal division.
- However, if the position of center of gravity is deviated from the center of supporting point extremely, it will be out of that limitation.
- Set the joint bar with the condition of no load applied.

Ⓐ Level adjustment procedures

• What is "Level adjustment"?
Each load cell part is adjusted so that the tare weight (weight of tank) is evenly adjusted.

Prepare for some liners. (0.1, 0.2, 0.5 and 1 mm)

• Adjustment procedure

Procedures: Check the allotment of the tare.

Insert some liners at the section of load cell whose division of tare weight portion is low.

Loosen the fixed bolts located at the bracket side.

Lift the tank up with a jack.

Insert the liners between the bracket and the top plate.

Then lower the tank.

Tighten the fixing bolts at the bracket side.

Ⓑ Adjustment on no load application on joint bar

• Reason: If some load is applied on the steel ball, there may have a fear of effect on accuracy.

• Check method: It checks that a joint bar moves by hand.

• Adjustment procedures: joint bar fixed nuts are loosened.

The joint bar is turned and rod end interval is made to expand and contract.

The joint bar fixed nut is bound tight after checking

the non-load of the joint bar.

