

DNQ10M (Nd Mg)

2023/03/22

Overview



dia. 55 × L30 DC Brushless motor outer rotor type

Motor Type : 3 Phase DC Brushless Motor

Direction of Rotation : CW and CCW

Control-Driver circuit built-in.

Compact, Light Weight and High Output

High Efficiency

Low Noise

Overcurrent and Locked Rotor Protection

The gear machined output, shaft type is available as an option.

Overall View

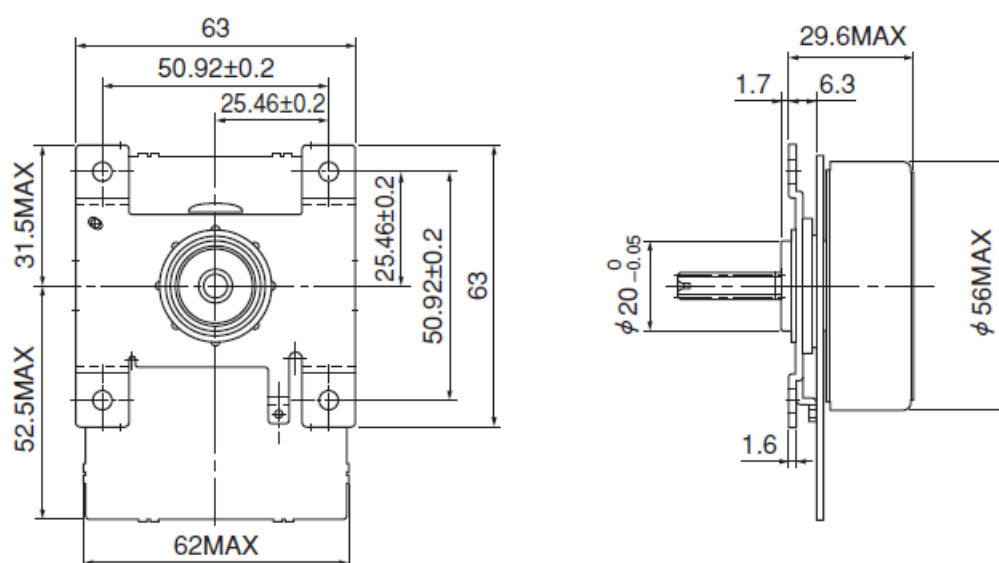

DNQ10M (Nd Mg)

2023/03/22

Specifications

Operating Voltage Min. [VDC]	21.6
Operating Voltage Nom. [VDC]	24
Operating Voltage Max. [VDC]	26.4
Operating Speed Min. [min-1]	600
Operating Speed Max. [min-1]	3000
Continuous Rating Power Max. [W]	40
Rotor Inertia (Reference Value) Nom. [g · cm ²]	565
Operating Temperature Min. [deg.C]	0
Operating Temperature Nom. [deg.C]	20
Operating Temperature Max. [deg.C]	50
Operating Humidity Min. [%RH]	15
Operating Humidity Max. [%RH]	90
Motor Weight Max. [g]	270

Please contact our sales for detail specification & order lot QTY. (All custom product by customer's requirement)

DNQ10M (Nd Mg)

2023/03/22

Property

