

17PM-F(42□ 1.8°)

2024/02/28

Appearance

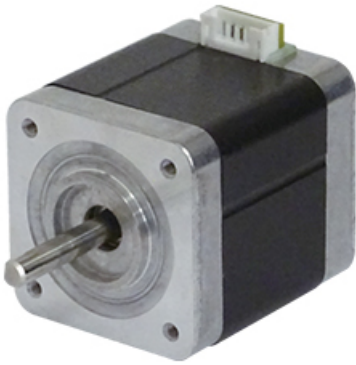

Overall View

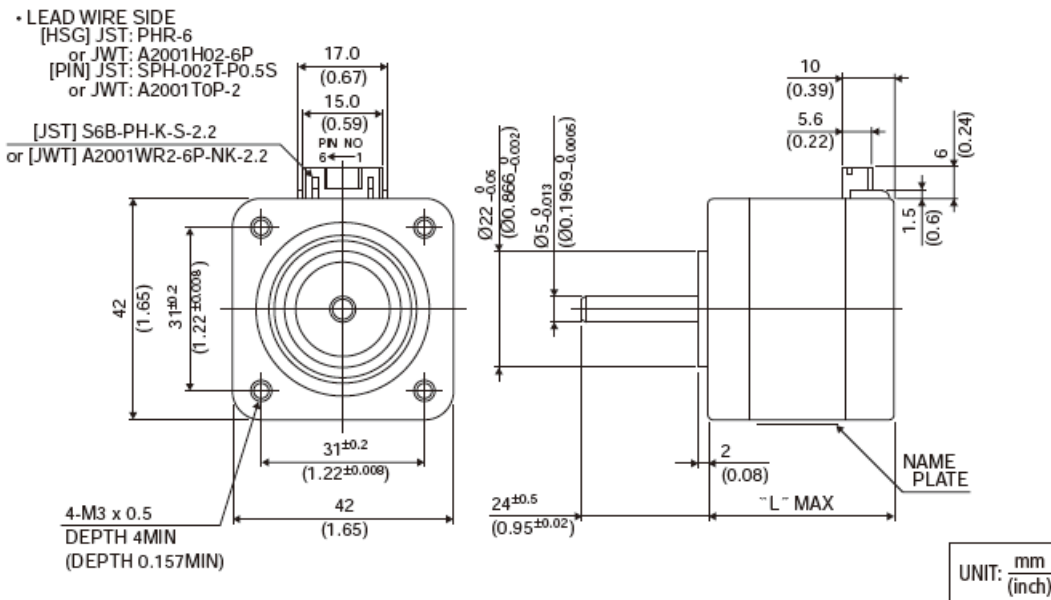

Size

17PM-F(42□ 1.8°)

2024/02/28

Model	size "L" [mm]	size "L" [Inch]
17PM-F8**	40.0	1.57
17PM-F1**	42.0	1.65
17PM-F4**	48.0	1.89
17PM-FA**	60.0	2.36

Wiring Diagram

PHASE	A	A/	B	B/
PIN NO.	4	6	3	1

Specifications

Model	Outer Diameter [mm]	Step Angle [°]	Drive Sequence	Rated Current [A]	Resistance [ohms]	Holding Torque [mN · m]
17PM-F848B	42.0	1.800	BI-POLAR	1.10	2.70	310
17PM-F856B	42.0	1.800	BI-POLAR	0.90	4.70	310
17PM-F140B	42.0	1.800	BI-POLAR	1.70	1.40	340
17PM-F144B	42.0	1.800	BI-POLAR	1.40	2.10	340
17PM-F148B	42.0	1.800	BI-POLAR	1.10	3.00	340
17PM-F156B	42.0	1.800	BI-POLAR	0.90	5.50	340
17PM-F438B	42.0	1.800	BI-POLAR	2.00	1.10	430
17PM-F442B	42.0	1.800	BI-POLAR	1.60	1.90	430
17PM-F452B	42.0	1.800	BI-POLAR	1.00	5.00	430
17PM-F449B	42.0	1.800	BI-POLAR	1.20	3.60	430
17PM-FA38B	42.0	1.800	BI-POLAR	2.00	1.80	690
17PM-FA49B	42.0	1.800	BI-POLAR	1.30	4.50	690

Inductance	Rotor Inertia	Detent Torque	Mass
------------	---------------	---------------	------

17PM-F(42□ 1.8°)

2024/02/28

Model	Inductance [mH]	Motor Inertia [g · cm ²]	Detent Torque [mN · m]	Mass [g]
17PM-F848B	4.2	76.0	14.7	300
17PM-F856B	6.9	76.0	14.7	300
17PM-F140B	2.2	84.0	18.6	320
17PM-F144B	3.3	84.0	18.6	320
17PM-F148B	4.8	84.0	18.6	320
17PM-F156B	8.5	84.0	18.6	320
17PM-F438B	2.3	110.0	23.5	380
17PM-F442B	3.8	110.0	23.5	380
17PM-F452B	9.0	110.0	23.5	380
17PM-F449B	6.9	110.0	23.5	380
17PM-FA38B	2.8	162.0	29.4	510
17PM-FA49B	9.2	162.0	29.4	510

Torque/Speed Characteristics

Model No: 17PM-F140B,F144B,F148B,F156B
 Driver: Chopper Dual
 Supply Voltage: 24.0 (Volt)

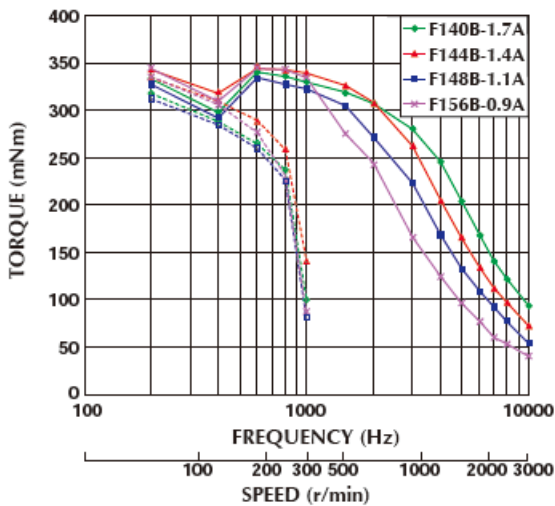

Model No: 17PM-F438B,F442B,F449B,F452B
 Driver: Chopper Dual
 Supply Voltage: 24.0 (Volt)

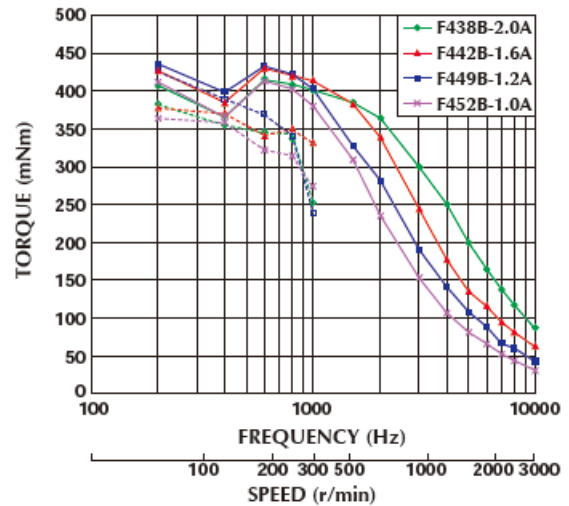

Model No: 17PM-F848B,F856B
 Driver: Chopper Dual
 Supply Voltage: 24.0 (Volt)

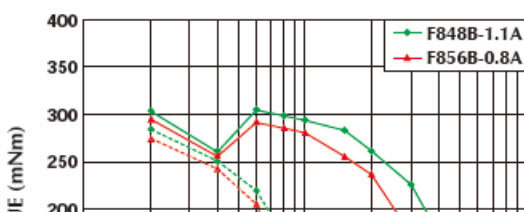

Model No: 17PM-FA38B,FA49B
 Driver: Chopper Dual
 Supply Voltage: 24.0 (Volt)

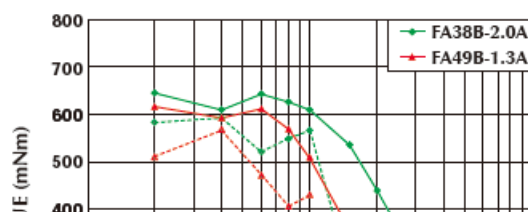

17PM-F(42□ 1.8°)

2024/02/28

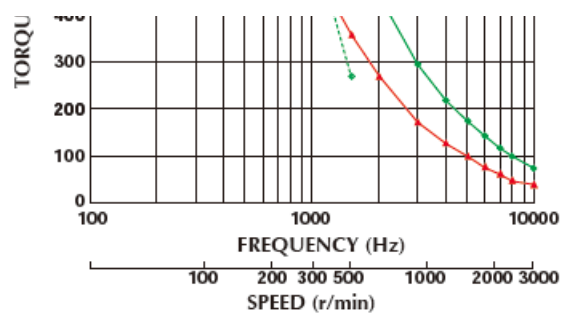
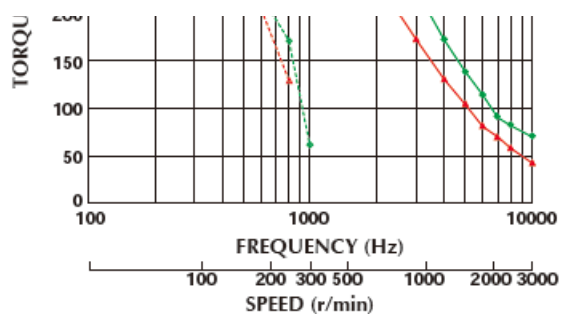

Case Studies

We can customize to meet your various requests! [Stepping motors]